

PRODUCT GUIDE

2022/2023



GRESHAM



GRESHAM

WELCOME.

As one of the UK's leading designers and manufacturers of workplace furniture, our portfolio encompasses office desking, seating, storage and screens plus conference, leisure and breakout collections, offering an holistic solution to your furniture requirements.

We are proud to showcase our extensive collection of products combining design, quality and functionality from a 'True UK Manufacturer'. The latest additions and unique styles complement our established ranges and offer solutions for all environments. Due to our manufacturing capability we can also offer bespoke products to suit your exact requirements, therefore if you do not see the product or style you require, please contact our Sales Office.

• HEAD OFFICE

Platinum Park, Lynstock Way,
Horwich, Bolton BL6 4SA
Tel: 01204 664422
Fax: 01204 664433
Email: info@gof.co.uk

• LONDON SHOWROOM

65 Clerkenwell Road,
London, EC1R 5BL
Tel: 020 7242 5709
Email: londonshowroom@gof.co.uk

CONTENTS

PRODUCT GUIDE 2022/2023

DESKING

Bench ² Access Top.....	32
Bench ² Accessories & Cable Trays.....	46
Bench ² Fixed Top.....	38
Bench ² Height Adjustable.....	44
Bench ² Scallop Top.....	34
Cable Management.....	86
D3K Manual Height Adjustable.....	56
D3K Fully Welded.....	76
Design 2000 Fully Welded.....	78
Deskit.....	68
Electrical Accessories.....	88
EX10 Executive.....	57
Home Worker.....	74
Mesa & Mesa Plus.....	48
Modular Reception Units.....	80
Monitor Arm & Accessories.....	94
Rise.....	60
Rise LT.....	64
Rise Squared.....	66
Script.....	10

TABLES

Bench ²	138
Betibo.....	NEW 100
D3K.....	140
Deck.....	128
Doc.....	148
EX10 & X10.....	142
GC1.....	152
GC4.....	154
GD1.....	104
GD3.....	179
GD10.....	106
GD10 Cirque.....	NEW 115
GD27.....	180
iMedia.....	136
Laptop & Utility.....	181
LS21.....	118
LS22.....	119
LS23.....	120
LTA.....	166
LTC.....	168
LTD.....	170
LTF.....	172
Moment.....	122
Multi-Purpose.....	162
Occasional.....	165
Plectra.....	147
Reception.....	176
Relo.....	NEW 182
Stand Height.....	146
Steps.....	150
Swing Out.....	116
Telford Adapt.....	149
Telford Fixed Top.....	160
Telford Folding Leg.....	158
Telford Folding Leg.....	159
Telford Tilt Top.....	156
Telford Segment.....	161
Vona.....	178

SCREENS & PODS

Barrier Screens.....	250
Cluster Screens.....	254
Curved Vision Panels.....	256
Free Standing Desktop Screens.....	252
GE6.....	218
GE Acoustics.....	248
GE Mobile Pods.....	216
Glazed Vision Panels.....	251
GOF Desk Mounted Fixing Brackets.....	226
GOF Desk Mounted Linking Posts & Accessories.....	227
GOF Desk Mounted.....	220
GOF Floor Standing Link Posts & Accessories.....	240
GOF Floor Standing.....	228
GOF Goal Post.....	238
GOF Panels.....	236
Kulture Habitat.....	NEW 186
Mesa Plus.....	242
MFC and Acrylic Screens.....	259
Mirage Haze.....	212
Mirage Haze Phone Booth.....	214
Mirage Hutch.....	NEW 192
Mirage Lite.....	243
Mirage Pods.....	194
Mirage Trees.....	NEW 234
Mobile Floor Standing Screens.....	257
Screen Brackets and Accessories.....	253
Static Floor Standing Screens.....	258

STORAGE

Bookcases & Pigeon Hole Units.....	274
Cabinets & Units.....	269
Kulture Quoll.....	280
Modular.....	276
Modular Credenzas & Mobile Units.....	278
Pedestals.....	262
Pedestals & Storage Units.....	264
Planters.....	284
Steel Units & Lockers.....	285
System Capacity Planning.....	268
System.....	266
Top & Base Units.....	272

BESPOKE

Case Studies.....	292
Finishes & Additions.....	290
Introduction.....	286
Our Process.....	288

TASK & VISITOR

Adlington.....	336
Adlington Mesh.....	338
Bromley 24/7.....	340
G Series Fabric.....	318
G Series Mesh.....	319
Harlequin Executive.....	313
Harlequin Mesh.....	331
Industrial.....	342
Keeko.....	312
LS37.....	343
Move Up.....	320
Oscar.....	308
Platinum Ergo.....	326
Platinum Mesh.....	330
Platinum Plus Round.....	322
Platinum Plus Squared.....	324
Platinum Squared.....	328
Santis Ergo.....	334
Santis Squared.....	335
Tag.....	332
Take Off Executive.....	314
Take Off.....	316
Tamper Proof.....	341
Task Seating Arms.....	306
Task Seating Mechanisms.....	304

CONFERENCE, MEETING & CAFÉ

A51.....	394
Alsen.....	376
BL6.....	393
Bretten.....	396
Cafe & Bistro.....	388
Coso.....	374
Garo.....	392
GC5.....	384
GC7.....	382
GD2 Stool.....	378
GD3 Stool.....	380
Heavy Duty.....	430
Hour.....	385
Kast.....	346
Kempton.....	427
Lahr.....	372
LC11 Chrome.....	352
LC11 Gas.....	356
LC11 Sled.....	348
LC11 Star.....	350
LC11 Stool.....	354
LC11 Wood.....	351
LC14 Metal.....	368
LC14 Stool.....	367
LC14 Wood.....	369
LC17 Wood.....	357
LC18 Wood.....	358
LG1.....	365
LG2.....	366
LG4 Chrome.....	362
LG4 Plastic.....	360
LG4 Wood.....	361
LG27.....	381
LG31.....	386
LG33.....	375
Link Plus.....	433
LS36.....	364
Meroux.....	397
Meeting Chair.....	422
Metric Plus.....	424
Metric Plus Executive.....	426
Mod.....	428
Note.....	399

Oli.....	404
Onio.....	395
Qus.....	370
SJX.....	406
Theia.....	400
Turn.....	432
Visa.....	390
Vona.....	398
Zela.....	414

SOFT SEATING, RECEPTION & BREAKOUT

Adore.....	462
Alvier Sled Leg.....	476
Alvier Tube Leg.....	478
Alvier Wooden Leg.....	474
Atrium.....	519
Betibo.....	466
Betsy.....	460
Chatte.....	516
Claire.....	515
Cubes & Arrows.....	526
Curves, Ovals & Rectangles.....	530
Doodh.....	533
Gallen.....	470
Hecta.....	454
Izzy.....	480
Izzy Lite.....	482
Klyro High Back.....	438
Klyro Low Back.....	440
Klyro Meeting Chair.....	442
Kulture Capaldi.....	508
LG10.....	467
LG30.....	465
Little Hecta.....	456
LS24.....	506
LS35.....	532
Lynstock Choice Reception.....	523
Masca.....	458
Moons & Rounds.....	528
Motile.....	464
Nao.....	514
Neos.....	510
Newton.....	525
Opo.....	468
Osana Bench.....	NEW 486
Outwood.....	520
Oxy.....	518
Pennine.....	524
Relo.....	NEW 436
Richmond.....	513
Solent.....	522
Sound Station.....	512
Steps 4 Star Base.....	450
Steps Castor Base.....	452
Steps Sled Base.....	448
Steps Swivel Base.....	444
Steps Swivel Wood Clad Base.....	446
Stratt Plus.....	511
Take Off.....	498
Take Off Lite.....	504
Take Off Plus High Back.....	502
Take Off Plus Low Back.....	500
Take Up.....	490
Take Up Booth.....	494
Tiros.....	NEW 484
Uono Booth.....	NEW 488

BEAM SEATING

Elsa Beam.....	540
Jonquill Beam.....	538
Note Beam.....	544
SJX Beam.....	534
Zela Beam.....	536

TECHNICAL INFORMATION

Beam Seating Specification.....	549
Gallen Dimensions.....	550
Seating Dimensions.....	552
Take Up Booth Dimensions.....	551

FABRICS & FINISHES

Selected Band Fabrics.....	564
Wood, Metal & Laminate Finishes.....	568

Due to a policy of continuous product improvement & development, we reserve the right to change detail or discontinue products without prior notification. All prices featured are retail and are subject to your agreed contractual/discount structure. VAT is applicable at the current rate. The contents in this brochure is for general information purposes only. Whilst we endeavour to ensure that the information in this brochure is correct, no warranty, express or implied, is given as to its accuracy and we do not accept any liability for error or omission.

OUR STORY

PRODUCT GUIDE 2022/2023



WE HAVE BEEN DESIGNING WORK SPACES AND FURNITURE SINCE **1976.**

We employ more than 250 people based at our 200,000sq ft office and factory space in Greater Manchester. Our 'Investors in People' award demonstrates how much we value our workforce. They are expertly skilled to design, produce and install superb workspace furniture. Owned and run by family members, we are proud to be a 'True UK Manufacturer' and share with you the benefits of high quality British goods. As well as clients across the UK, we also export our products internationally.

Since most of us spend many hours each day at work, it is important that we feel both comfortable and happy within that working environment. At Gresham, we consider every aspect of our workspace furniture, through concept and detailed design, prototyping and testing, through to production, assembly and despatch - all backed-up with our dedicated Customer Care team. All of this happens under one roof at our state-of-the-art headquarters in Bolton, with all of our teams working together to ensure we supply the best products and services to you.



Made in Britain brings together the British manufacturing community, united with the use of the registered collective mark. The mark is protected and can only be used by members of Made in Britain that meet the criteria we set to guarantee the member is a British manufacturer.



Gresham is proud to be a member and support the aims and objectives of the trade organisation ACID (Anti Copyright in Design). All of Gresham's designs are supported by ACID through their Copyright & Design Databank and ACID Marketplace.

All intellectual property rights existing in our designs and products (and in the images, text and design of this marketing material) are and will remain the property of Gresham Office Furniture. Any infringement of these rights will be pursued seriously.

DESIGN WITH YOU IN MIND

PRODUCT GUIDE 2022/2023



GRESHAM DESIGN

Gresham works with some of the finest designers to create individual pieces that reflect your personality and enhance your workspace. The company's in-house team boasts experienced designers with backgrounds in Product Design, Industrial and Furniture Design, Design Engineering, Interior Design and Graphics, to name but a few.

Based at our Bolton studio, our team come from a myriad of disciplines, bringing their expertise to create inspiring designs. Whether for mainstream products, special variations or totally bespoke solutions, we provide a complete service from concept through manufacturing to presentation and hand-over. Working in a high-pressure commercial environment, our team needs to balance creativity and flair with quality.

We continually explore innovations in technology, materials and processing, as well as keeping abreast of style, popular colour trends and the ever-adapting workplace. It's all about getting it right.

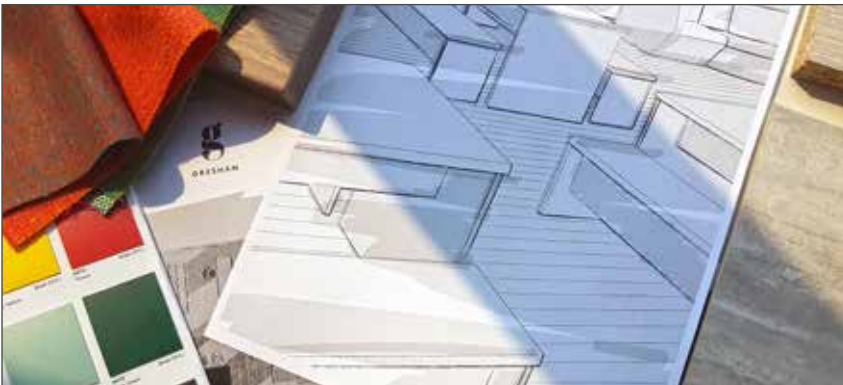

CAD FILES

GRESHAM CREATE OUR CAD FILES FOR USE WITHIN AUTOCAD, REVIT, PCON PLANNER, SKETCH UP AND 3DS MAX.

Gresham support our clients by implementing the BIM approach to all of our projects. BIM (Building Information Modelling) is a collaborative way of working allowing different sectors to work on one central model. This process means that Architects, Specifiers and Planners can work smarter, faster and cheaper by sharing standardised design information.

PCon Planner and SketchUp are 3D CAD software packages that are free to download and can be used for planning. They are fast becoming the industry standard which is why we create our portfolio in this format. We upload all of our models to 'The 3D Warehouse' - the world's biggest resource for free 3D CAD models.



INSTALLATION

All installations are undertaken by highly trained & experienced staff at times to suit you. All packaging is removed from site and returned to the factory for recycling.



LOCAL SERVICE

We provide you with peace of mind that you can access products locally from a renowned manufacturer.



PROJECT MANAGEMENT

We provide total Project Management from initial enquiry through to installation. A single point of contact ensures efficiency and avoids tying up your own valued resources.



ERGONOMIC TRAINING

We provide on site ergonomic training to make sure users are familiar with our products ensuring correct seating and posture.

ENVIRONMENT
 PRODUCT GUIDE 2022/2023



FSC® FOREST STEWARDSHIP
 COUNCIL®.

Its purpose is to promote responsible management of the world’s forests through developing standards, a certification system and trademark recognition. The process of tracking a product back to forest is called “Chain-of-Custody (COC) Certification. Through the COC, companies can demonstrate their commitment to the environment and responsible material sourcing.

Over 99% of the Melamine Faced Chipboard used in the manufacture of office and leisure furniture has been sourced from FSC® certified suppliers. The 1% remaining material, although not FSC® is sourced from non-controversial sources. No trees are cut down specifically to produce MFC.



The mark of
 responsible forestry

REDUCING CARBON
 EMISSIONS.

We are committed to reducing our carbon footprint by instigating strategies which will reduce the use of fossil fuels and the amount of greenhouse gases produced by our processes. We continually invest in state of the art equipment to make manufacturing more efficient. We recycle our waste, reducing landfill and continually update our fleet of vehicles to ensure the latest engine technology is employed.



ACCREDITATIONS & CERTIFICATIONS

PRODUCT GUIDE 2022/2023

All products are designed and manufactured in conformity to the relevant British and European standards.

Gresham Office Furniture's manufacturing process is achieved in line with the following Accreditations and Certifications:



ISO 14001 : 2015

Environmental Management System.
Initial Registration: May 2001



ISO 45001 : 2018

Health & Safety Management System



Chain of Custody Certification

Initial Certification: December 2004



BS EN ISO 9001 : 2015

Quality Management System - ISO 9001: 2015
Full Member



BCFA

British Contract Furnishing Association. Full Member



INVESTORS IN PEOPLE

New standard for Training, Commitment, Planning and Communications.
Achieved March 2001



CONSTRUCTION LINE

UK's largest register for pre-qualified contractors and consultants. Full Member



SAFE CONTRACTOR

Health & Safety Assessment Scheme.



FIRA

Furniture Industry Research Association.
Full Member



FISP

Furniture Industry Sustainability Programme. Full Member



GREEN GROWTH

Made in Britain Green Growth Programme



CHAS

Contractors Health and Safety Assessment Scheme.
Full member since 2005.

INTRODUCTION

DESKING

Desking

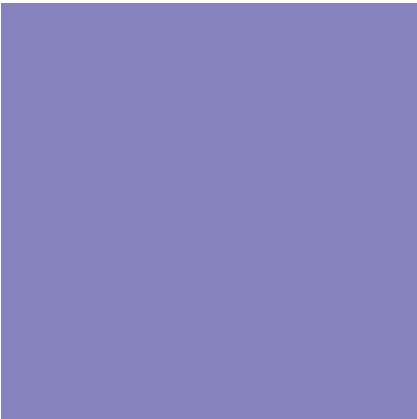
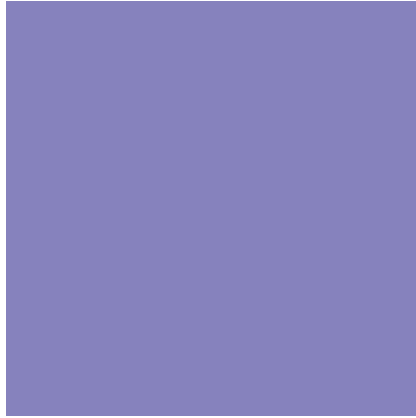



For optional standard pedestals and storage please see Storage section.



For optional cable management please refer to relevant product page or Cable Management in Desking section.



For optional desktop screens please refer to relevant product page or Screens section.



For optional desk accessories please refer to relevant product page or Monitor Arms & Accessories in Desking section.



For optional desk service modules please see Electrical Accessories in Desking section.



For metal finishes please see Technical Information section.

Pastel Paint
Surcharge = £32 per item.



For board finishes please see Technical Information section.

Adlington Oak
Surcharge = £64 per item
Light Concrete
Surcharge = £64 per item



For Screen fabrics please see Technical Information section.

- All Desking is available in a choice of MFC finishes.
- Unless otherwise stated all Desking is 727mm high with 25mm thick top panels.

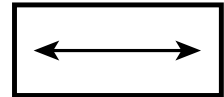

Denotes grain direction

LEG OPTIONS

Desking is offered in ranges of dimensions to allow you to plan the most convenient size within your work space. Each range is identified by their end frames which, as well as offering visual differences can incorporate features such as height adjustability or cable management.

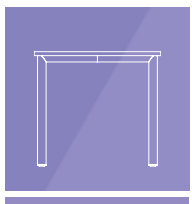

Script
Straight Leg



Script
Angled Leg



Bench²
Straight Leg



Bench²
Single Sided
Angled Leg

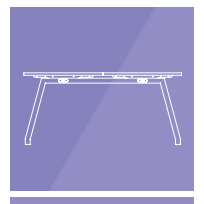

Bench²
Double Sided
Angled Leg



Rise / Rise Lite
Straight Leg

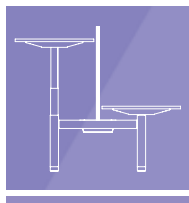

Rise²
Straight Leg

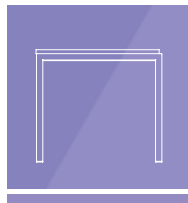

Mesa
Straight Leg

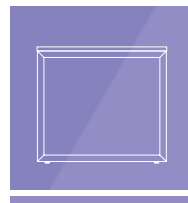

Mesa
Codi Leg

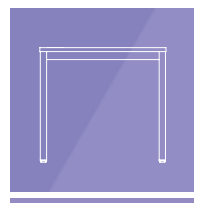

Deskits
Bench²



Deskits
D3K

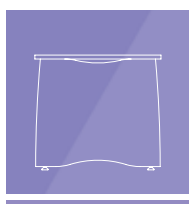

Deskits
EX10

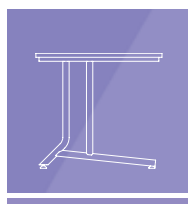

Deskits
X10



Deskits
Design 2000
Cantilever

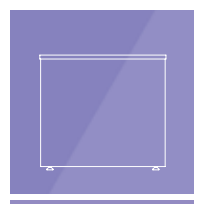

Deskits
Design 2000 Panel
End

SCRIPT RECTANGULAR DESKING

10 Year Guarantee

Desking

- Script is one of our most popular ranges. Clean, simple, striking and seamless.
- Available with Straight or Angled legs.
- 25mm deep Scallop for cable access.



Leg styles

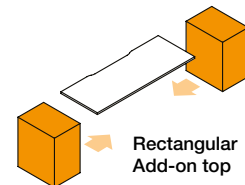
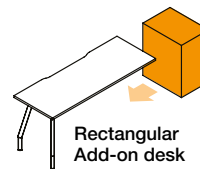
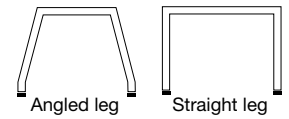

Angled leg Code	Straight leg Code	A	B	MFC Price
Rectangular desk 800mm deep				
XDA188	XDS188	1800 x	800	£482
XDA168	XDS168	1600 x	800	£465
XDA148	XDS148	1400 x	800	£445
XDA128	XDS128	1200 x	800	£428
XDA108	XDS108	1000 x	800	£410

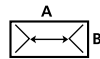

Angled leg Code	Straight leg Code	A	B	MFC Price
Rectangular 800mm deep, Add-on desk packs. Uses 800d Pedestal (not included)				
XDA188A	XDS188A	1800 x	800	£353
XDA168A	XDS168A	1600 x	800	£332
XDA148A	XDS148A	1400 x	800	£316
XDA128A	XDS128A	1200 x	800	£301
XDA108A	XDS108A	1000 x	800	£279

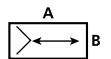

Angled leg Code	Straight leg Code	A	B	MFC Price
Rectangular desk 600mm deep				
XDA186	XDS186	1800 x	600	£393
XDA166	XDS166	1600 x	600	£372
XDA146	XDS146	1400 x	600	£358
XDA126	XDS126	1200 x	600	£340
XDA106	XDS106	1000 x	600	£322

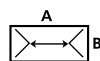

Angled leg Code	Straight leg Code	A	B	MFC Price
Rectangular 600mm deep, Add-on desk packs. Uses 600d Pedestal (not included)				
XDA186A	XDS186A	1800 x	600	£286
XDA166A	XDS166A	1600 x	600	£270
XDA146A	XDS146A	1400 x	600	£251
XDA126A	XDS126A	1200 x	600	£231
XDA106A	XDS106A	1000 x	600	£217

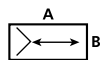

Suffix	Description	Surcharge
H	Desk legs (set of 4)	£73
	Desk legs (set of 2)	£36

All free standing desks can be fitted with Height adjustable legs. Provides 120mm adjustment.



800mm deep Rectangular Add-on Top Uses 800d Pedestal (not included)				
XD188		1800 x	800	£223
XD168		1600 x	800	£204
XD148		1400 x	800	£187
XD128		1200 x	800	£170

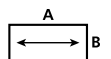

600mm deep Rectangular Add-on Top Uses 600d Pedestal (not included)				
XD186		1800 x	600	£186
XD166		1600 x	600	£165
XD146		1400 x	600	£148
XD126		1200 x	600	£132

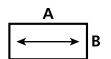

10 Year
Guarantee

SCRIPT RECTANGULAR DESKING

Desking

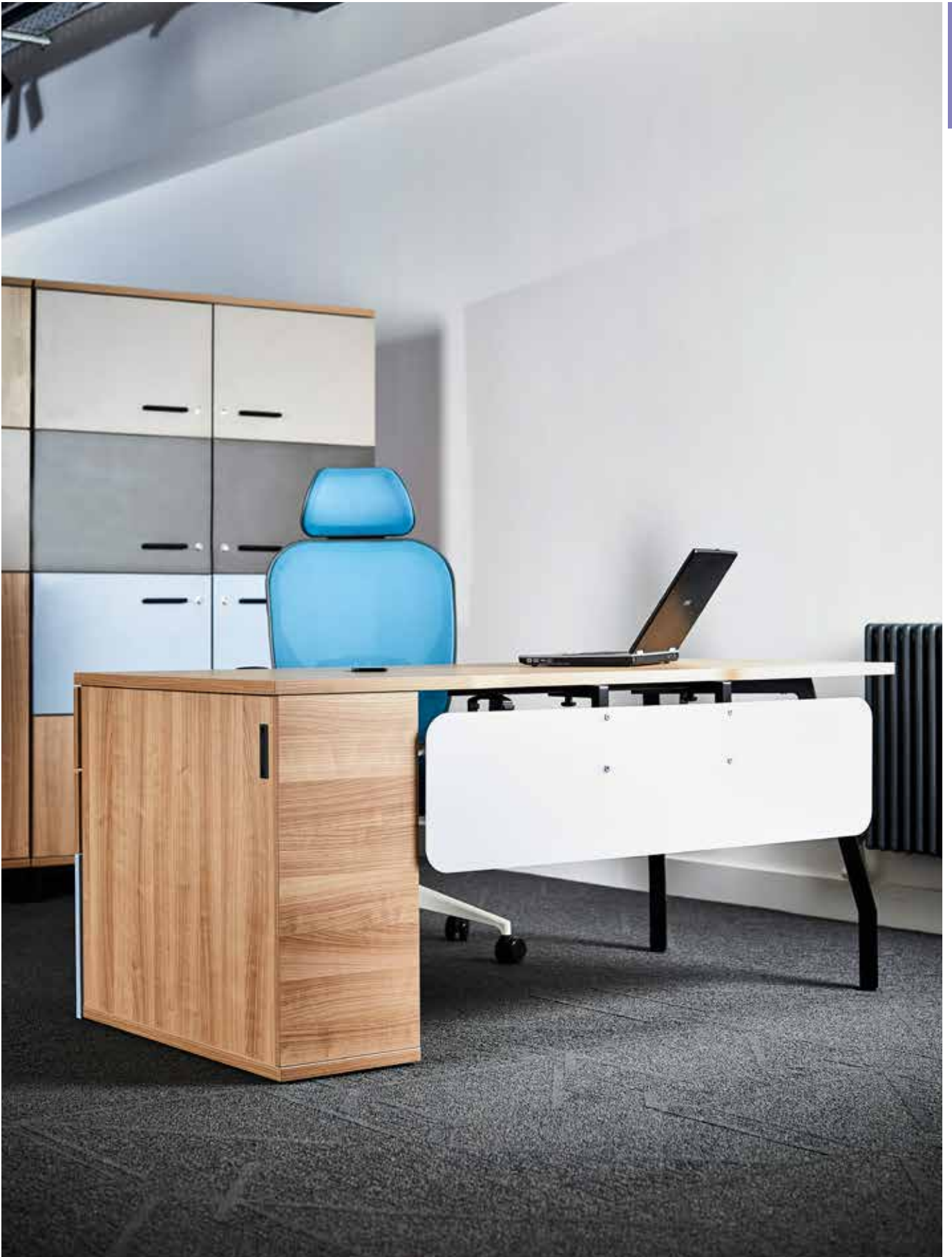

Rectangular Add-on Desk and Structural Standard Drawer Pedestal

SCRIPT RETURN UNITS DESKING

10 Year
Guarantee

Desking

Return units fit to the front edge of rectangular and angled wave desks (deeper end).

- Used to create right-angled workstations.
- Can fit to left or right hand sides.
- Fly-over top pedestals work the same way.



Leg styles

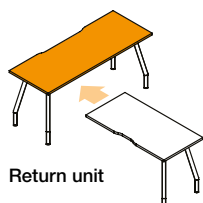
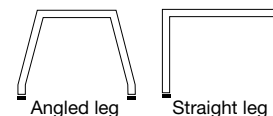

Return unit

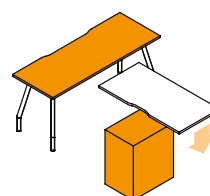

600mm deep Fly over Top - unhandred
Fits to front edge of workstation to form return unit.

Angled leg Code	Straight leg Code	A	B	MFC Price
-----------------	-------------------	---	---	-----------

Return desks

Main desk not included

Angled leg Code	Straight leg Code	A	B	MFC Price
XDRU126	XDRUS126	1200 x	600	£213
XDRU106	XDRUS106	1000 x	600	£205
XDRU086	XDRUS086	800 x	600	£203



Fly over top

600mm deep - unhandred uses 600d Pedestals.

Fits to front edge of workstation to form return. Pedestal not included.

Code	A	B	MFC Price
XFT12	1200 x	600	£134
XFT10	1000 x	600	£118
XFT08	800 x	600	£104



Suffix	Description	Surcharge
H	Desk legs (set of 2)	£36

All free standing desks can be fitted with Height adjustable legs. Provides 120mm adjustment.



10 Year
Guarantee

SCRIPT RETURN UNITS DESKING

Desking

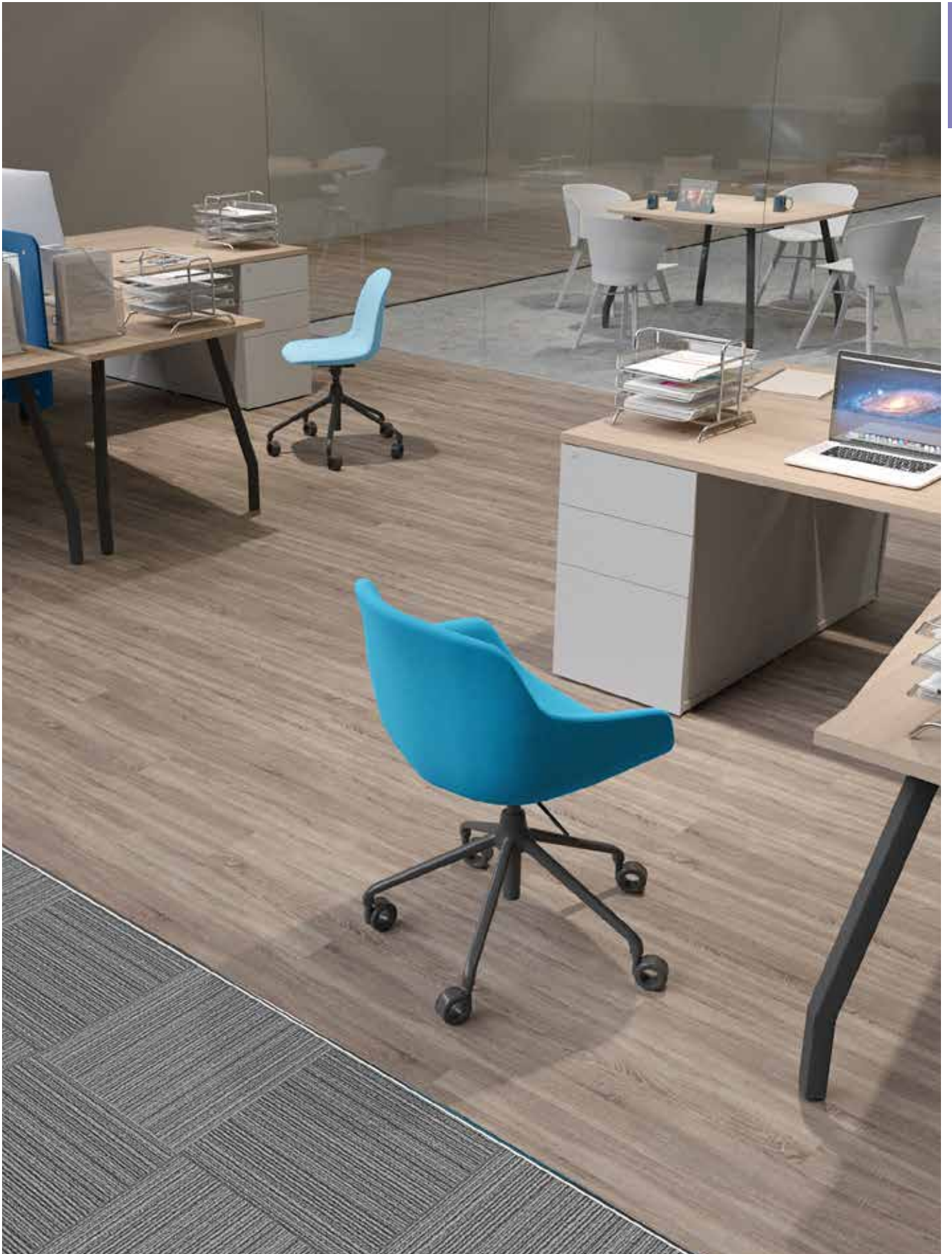

Angled Wave Desks and Fly Over Tops with Structural Standard Drawer Pedestals

SCRIPT ANGLED WAVE DESKING



Desking

Angled Wave desks function similarly to rectangular desks



- Users face one particular corner.
- Supplied in left or right hand variants.
- Can accept structural pedestals at 800mm end.

Leg styles

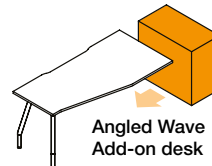
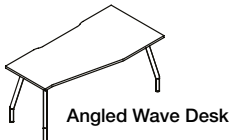
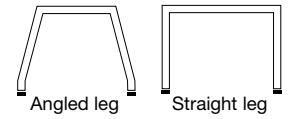

Angled leg Code	Straight leg Code	A	B	C	MFC Price
Angled Wave 1000 to 800mm deep - Right hand					
XWRA1810	XWRS1810	1800	800	1000	£503
XWRA1610	XWRS1610	1600	800	1000	£485
XWRA1410	XWRS1410	1400	800	1000	£468
XWRA1210	XWRS1210	1200	800	1000	£449
Angled Wave 1000 to 800mm deep - Left hand					
XWLA1810	XWLS1810	1800	800	1000	£503
XWLA1610	XWLS1610	1600	800	1000	£485
XWLA1410	XWLS1410	1400	800	1000	£468
XWLA1210	XWLS1210	1200	800	1000	£449
Angled Wave 800 to 600mm deep - Right hand					
XWRA1808	XWRS1808	1800	600	800	£449
XWRA1608	XWRS1608	1600	600	800	£432
XWRA1408	XWRS1408	1400	600	800	£413
XWRA1208	XWRS1208	1200	600	800	£395
Angled Wave 800 to 600mm deep - Left hand					
XWLA1808	XWLS1808	1800	600	800	£449
XWLA1608	XWLS1608	1600	600	800	£432
XWLA1408	XWLS1408	1400	600	800	£413
XWLA1208	XWLS1208	1200	600	800	£395

Angled leg Code	Straight leg Code	A	B	C	MFC Price
Angled Wave 800 to 600mm deep, Right hand Add-on desk packs. Uses 800d pedestal (not included)					
XWRA1808A	XWRS1808A	1800	600	800	£321
XWRA1608A	XWRS1608A	1600	600	800	£304
XWRA1408A	XWRS1408A	1400	600	800	£284
XWRA1208A	XWRS1208A	1200	600	800	£265
Angled Wave 800 to 600mm deep, Left hand Add-on desk packs. Uses 800d pedestal (not included)					
XWLA1808A	XWLS1808A	1800	600	800	£321
XWLA1608A	XWLS1608A	1600	600	800	£304
XWLA1408A	XWLS1408A	1400	600	800	£284
XWLA1208A	XWLS1208A	1200	600	800	£265

Suffix	Description	Surcharge
H	Desk legs (set of 4)	£73
	Desk legs (set of 2)	£36



All free standing desks can be fitted with Height adjustable legs. Provides 120mm adjustment.

10 Year
Guarantee

SCRIPT ANGLED WAVE DESKING

Desking



Angled Wave Desk

SCRIPT CURVED WAVE DESKING



Desking

Curved wave desks function similarly to rectangular desks.

- Users face one particular corner.
- Supplied in left or right hand variants.
- Can accept structural pedestals at narrower end.



Leg styles

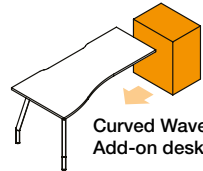
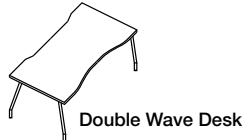
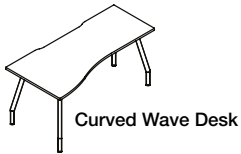
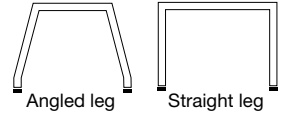

Angled leg Code	Straight leg Code	A	B	C	MFC Price
Curved Wave 1000 to 800mm deep - Right hand					
XEWRA1810	XEWRS1810	1800	800	1000	£503
XEWRA1610	XEWRS1610	1600	800	1000	£485
XEWRA1410	XEWRS1410	1400	800	1000	£468
XEWRA1210	XEWRS1210	1200	800	1000	£449
Curved Wave 1000 to 800mm deep - Left hand					
XEWLA1810	XEWLS1810	1800	800	1000	£503
XEWLA1610	XEWLS1610	1600	800	1000	£485
XEWLA1410	XEWLS1410	1400	800	1000	£468
XEWLA1210	XEWLS1210	1200	800	1000	£449
Curved Wave 800 to 600mm deep - Right hand					
XEWRA1808	XEWRS1808	1800	600	800	£449
XEWRA1608	XEWRS1608	1600	600	800	£432
XEWRA1408	XEWRS1408	1400	600	800	£413
XEWRA1208	XEWRS1208	1200	600	800	£395
Curved Wave 800 to 600mm deep - Left hand					
XEWLA1808	XEWLS1808	1800	600	800	£449
XEWLA1608	XEWLS1608	1600	600	800	£432
XEWLA1408	XEWLS1408	1400	600	800	£413
XEWLA1208	XEWLS1208	1200	600	800	£395
Double Wave 800 to 700mm deep					
XWDA1808	XWDS1808	1800	700	800	£485
XWDA1608	XWDS1608	1600	700	800	£468

Angled leg Code	Straight leg Code	A	B	C	MFC Price
Curved Wave 1000 to 800mm deep, Right hand Add-on desk packs Uses 800d pedestal (not included)					
XEWRA1810A	XEWRS1810A	1800	800	1000	£371
XEWRA1610A	XEWRS1610A	1600	800	1000	£356
XEWRA1410A	XEWRS1410A	1400	800	1000	£337
XEWRA1210A	XEWRS1210A	1200	800	1000	£321
Curved Wave 1000 to 800mm deep, Left hand Add-on desk packs Uses 800d pedestal (not included)					
XEWLA1810A	XEWLS1810A	1800	800	1000	£371
XEWLA1610A	XEWLS1610A	1600	800	1000	£356
XEWLA1410A	XEWLS1410A	1400	800	1000	£337
XEWLA1210A	XEWLS1210A	1200	800	1000	£321
Curved Wave 800 to 600mm deep, Right hand Add-on desk packs Uses 600d pedestal (not included)					
XEWRA1808A	XEWRS1808A	1800	600	800	£346
XEWRA1608A	XEWRS1608A	1600	600	800	£327
XEWRA1408A	XEWRS1408A	1400	600	800	£305
XEWRA1208A	XEWRS1208A	1200	600	800	£291
Curved Wave 800 to 600mm deep, Left hand Add-on desk packs Uses 600d pedestal (not included)					
XEWLA1808A	XEWLS1808A	1800	600	800	£346
XEWLA1608A	XEWLS1608A	1600	600	800	£327
XEWLA1408A	XEWLS1408A	1400	600	800	£305
XEWLA1208A	XEWLS1208A	1200	600	800	£291

10 Year
Guarantee

SCRIPT CURVED WAVE DESKING

Desking



Curved Wave Desks & Structural Steel Drawer Pedestals

SCRIPT 120° WORKSTATION DESKING

10 Year
Guarantee

Deskings

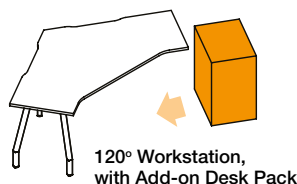

Leg Styles

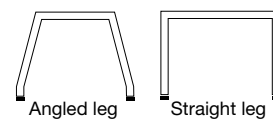

Angled leg Code	Straight leg Code	A	B	C	D	MFC Price	Angled leg Code	Straight leg Code	A	B	C	D	MFC Price
120° Workstation							120° Workstation, Add-on Desk Packs Pedestal Not Included						
XDY128	XDYS128	1200	800	800	1200		£783	XDY128A	XDYS128A	1200	800	800	
XDY126	XDYS126	1200	600	600	1200	£690	XDY126A	XDYS126A	1200	600	600	1200	£582

Suffix	Description	Surcharge
H	Desk legs (set of 6)	£109

All free standing desks can be fitted with Height adjustable legs. Provides 120mm adjustment.



Conference Ends

Angled leg Code	Straight leg Code	Description	A	B	MFC Price
XSCT16	XSSCT16	Semi-Circular	1640	820	£347
		Semi-Circular	1240	620	£316
XSET16	XSSET16	Semi-Elliptical	1640	600	£322
		Semi-Elliptical	1240	450	£293



Semi - Circular Conference End shown with Add-on Desk and Drop Height Storage

10 Year
Guarantee

SCRIPT 120° WORKSTATION DESKING

Desking



120° Workstation

SCRIPT STRUCTURAL PEDESTALS DESKING

10 Year
Guarantee

Desking

Structural Pedestals can be used to replace leg frames.

- Used with Add-on desks or Add-on Tops.
- Cost effective solution.
- Can be shared between two workspaces.
- 800 deep to suit 800 deep Add-on desks or Add-on Tops.
- 600 deep to suit 600 deep Add-on desks or Add-on Tops.

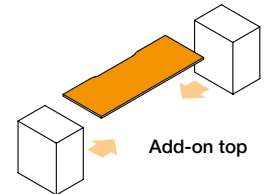
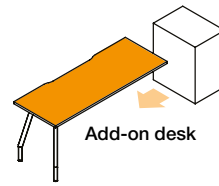

Code W D MFC Price

430mm width - 2 shallow & 1 Filing Drawer
Replaces single fixed height leg as support
on Add-on units

3XFP8 430 x 800 £413
3XFP6 430 x 600 £389



300mm width - 2 shallow & 1 Filing Drawer
Replaces single fixed height leg as support
on Add-on units

3XSFP8 300 x 800 £413
3XSFP6 300 x 600 £389



Pen tray -
For use in standard drawer units

EPT £20



Code Description W D MFC Price

Structural Hinged Door Storage with Single Shelf
Available in all MFC wood finishes. White can have white
or wood grained door - must be specified.

XHPRW83 Right hand 300 x 800 £331
XHPRW63 Right hand 300 x 600 £316

XHPLW83 Left hand 300 x 800 £331
XHPLW63 Left hand 300 x 600 £316



Structural Hinged Door Storage with Single Shelf
Available in all MFC wood finishes. Frosted Opal Acrylic Door.

XHPRA83 Right hand 300 x 800 £486
XHPRA63 Right hand 300 x 600 £463

XHPLA83 Left hand 300 x 800 £486
XHPLA63 Left hand 300 x 600 £463



Rectangular Add-on tops & Structural Slim Line Steel Drawer Pedestals

SCRIPT STRUCTURAL SHELVING DESKING

Structural Storage can be used to replace leg frames.

- Used with Add-on desks or Add-on Tops.
- Cost effective solution.
- Available open fronted or with sliding door options.

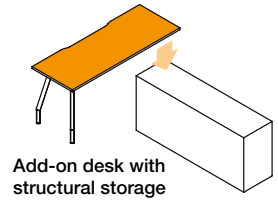
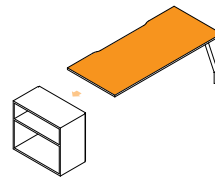

Add-on desk with structural storage

Code	To fit	MFC Price
800 & 600 x 434mm Open fronted unit		
Replaces single leg as support unit - Can face both ways		
XSUB08	800 deep	£203
XSUB06	600 deep	£189

1600 x 434mm Open fronted unit		
Replaces single leg as support unit - Can face both ways		
XSUB168	800 deep	£367
XSUB166	600 deep	£367

1600 x 434mm Open fronted unit with full width top (can be used as standalone)		
XSUB16		£435

1600 x 434mm Single wooden sliding door		
Replaces single leg as support unit - Can face both ways		
XSWD168	800 deep	£519
XSWD166	600 deep	£519

1600 x 434mm Single wooden sliding door full width top (can be used as standalone)		
XSWD16		£587

Code	To fit	MFC Price
800 & 600 x 320mm Slimline Open fronted unit		
Replaces single leg as support unit - Can face both ways		
XSUBS08	800 deep	£203
XSUBS06	600 deep	£189

1600 x 320mm Slimline Open fronted unit		
Replaces single leg as support unit - Can face both ways		
XSUBS168	800 deep	£367
XSUBS166	600 deep	£367

1600 x 320mm Slimline Open fronted unit with full width top (can be used as standalone)		
XSUBS16		£435

1600 x 320mm Slimline Single wooden sliding door		
Replaces single leg as support unit - Can face both ways		
XSWDS168	800 deep	£519
XSWDS166	600 deep	£519

1600 x 320mm Slimline Single wooden sliding door full width top (can be used as standalone)		
XSWDS16		£587

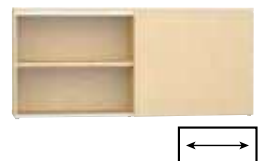
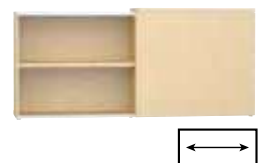
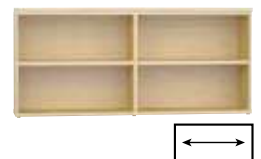
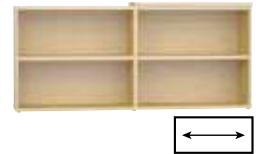
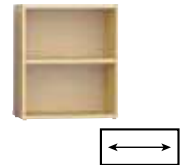

SCRIPT OVER DESK STORAGE DESKING

10 Year
Guarantee

Desking

Over Desk Storage file hutches for workspaces.

- Can fit to the rear or side of units.
- Can fit to top of desks or storage units.
- Can be retro-fitted.



Code W D H MFC Price

Open Fronted Desk File Hutch

Fits to all standard desk models and can be retro fitted



XFH16	1584	x	334	x	375	£242
XFH10	1000	x	334	x	375	£187
XFH08	800	x	334	x	375	£170
XFH06	600	x	334	x	375	£164



1000mm, 800mm & 600mm



1584mm

Examples of
configuration

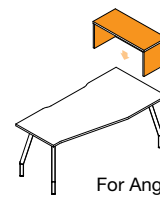
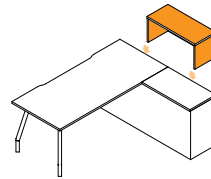
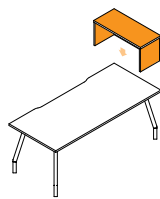
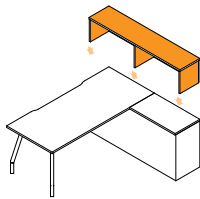

For Angled Wave



Rectangular Add-on desk with Structural Storage & File Hutch



Cable Baskets offer simple cable control under desk worksurfaces.

- Can be retro-fitted.
- Baskets can be positioned in a choice of two heights.
- Baskets are offered in a selection of colours to match legs.

Basket can fit on suspension brackets in two positions:

1. To accommodate tall under desk pedestals under tray.
2. To accommodate transformer plugs in basket. Basket can be unhooked from suspension brackets on one side to provide easy access to cables and modules.

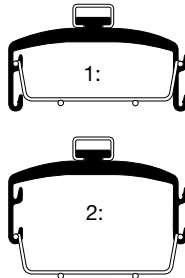

Cable Baskets can be used in a non-modular way i.e. smaller baskets can be fitted where required on a larger desks, e.g. 800 Cable Basket can be fitted on to 1600 Desk.



Horizontal Cable Basket - available in Black, Grey, Silver or White. Fits to under desk service rail or suspension brackets can be screwed directly to the underside of the work surface.

Code	Basket length	Top size	Price	Cable Basket positions
MECT16	1426	1800	£82	
MECT14	1222	1600	£81	
MECT12	1019	1400	£76	
MECT10	816	1200	£73	
MECT08	612	1000	£71	
MECT06	410	800	£67	
MECT12	1019	1800	£76	
MECT10	816	1600	£73	
MECT08	612	1400	£71	
MECT06	410	1200	£67	
MECT10	816	1800	£73	
MECT08	612	1600	£71	
MECT06	410	1400	£67	

Return Side Service Rail Pack
Used to suspend cable trays, divider screens on desk ends and return side of desk.



XSRR Fits to 600, 800 & 1000 Sides £32

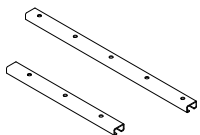

Structural pedestals have cable pass through to the rear

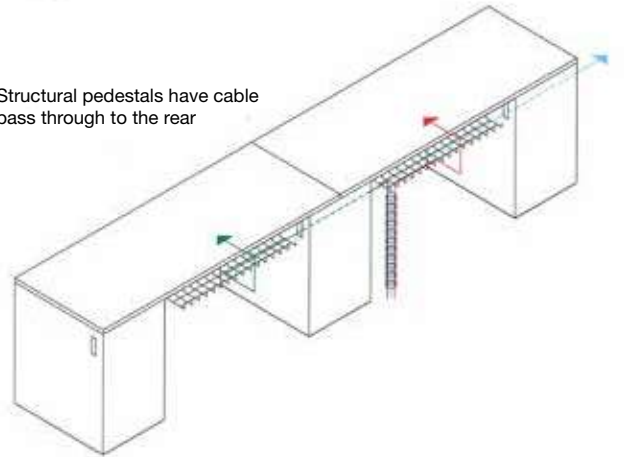

Drop height structural units allow continuous cable management throughout clustered desks.

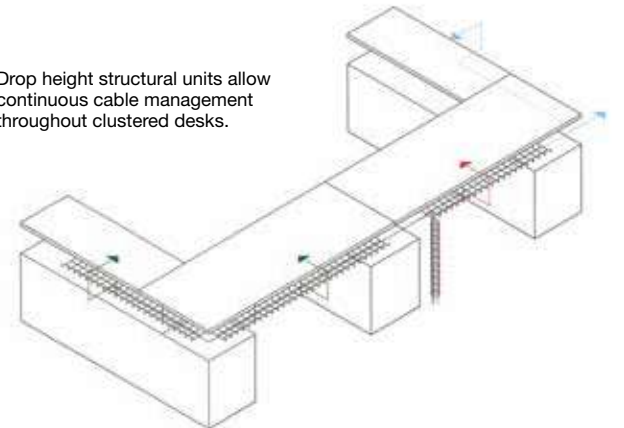

SCRIPT MODESTY PANELS DESKING

10 Year
Guarantee

Desking

Modesty panels can be fitted to individual Script desks to cover the knee space of the user.

- Optional – need only be specified where required.
- Available in Wooden MFC and Frosted Opal Acrylic.
- Can be fitted in a variety of positions to suit user needs.



Wooden MFC Code	Acrylic Code	Top Size	Wooden MFC Price	Acrylic Price
XCPW18	XCPA18	1800	£141	£278
XCPW16	XCPA16	1600	£103	£261
XCPW14	XCPA14	1400	£102	£245
XCPW12	XCPA12	1200	£100	£171
XCPW10	XCPA10	1000	£85	£139
XCPW08	XCPA08	800	£74	£102
XCPW06	XCPA06	600	£66	£71

Suspended modesty panel positions

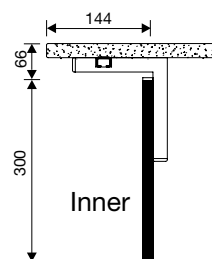
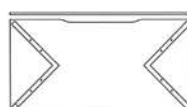

XCPW14	XCPA14	1800	£102	£245
XCPW12	XCPA12	1600	£100	£171
XCPW10	XCPA10	1400	£85	£139
XCPW08	XCPA08	1200	£74	£102
XCPW06	XCPA06	1000	£66	£71

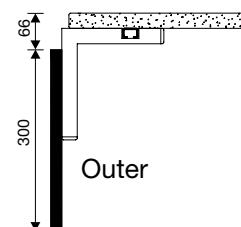
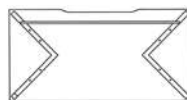

XCPW10	XCPA10	1800	£85	£139
XCPW08	XCPA08	1600	£74	£102
XCPW06	XCPA06	1400	£66	£71

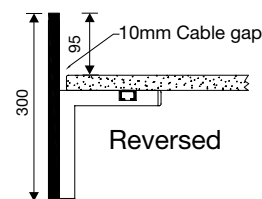
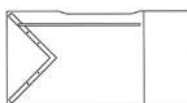

XCPW08	XCPA08	1800	£74	£102
XCPW06	XCPA06	1600	£66	£71

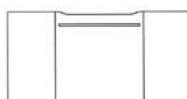

Opal Acrylic Modesty Panel (Inner) & Cable Basket

Desk Mounted Screens can be fitted to individual or clustered desks.

- Offers user privacy.
- Delineate personal space.
- Desk mounted screens available in Wooden MFC, Frosted Opal Acrylic and Fabric.
- Full height screens available in MFC.

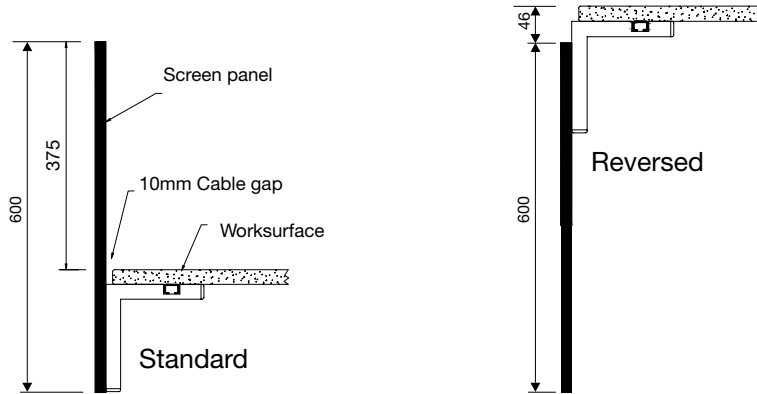

Code	W	H	Band 1 Price	Band 2 Price	Band 3 Price
Fabric screens - 600 high 375 above desk					
XSDF184	1790 x	600	£261	£299	£356
XSDF164	1590 x	600	£251	£277	£333
XSDF144	1390 x	600	£202	£229	£284
XSDF124	1190 x	600	£192	£220	£261
XSDF104	990 x	600	£168	£192	£235
XSDF084	790 x	600	£159	£177	£203
XSDF064	590 x	600	£140	£168	£189

Code	W	H	Price
Frosted Opal Acrylic screens - 600 high 375 above desk			
XSDA184	1790 x	600	£435
XSDA164	1590 x	600	£432
XSDA144	1390 x	600	£427
XSDA124	1190 x	600	£421
XSDA104	990 x	600	£262
XSDA084	790 x	600	£226
XSDA064	590 x	600	£192

*MFC screens - 600 high 375 above desk			
XSDW184	1790 x	600	£162
XSDW164	1590 x	600	£155
XSDW144	1390 x	600	£144
XSDW124	1190 x	600	£134
XSDW104	990 x	600	£121
XSDW084	790 x	600	£113
XSDW064	590 x	600	£103

*M.F.C - Full height 375 above desk			
XSDW1811	1790 x	1110	£342
XSDW1611	1590 x	1110	£323
XSDW1411	1390 x	1110	£304
XSDW1211	1190 x	1110	£280
XSDW1011	990 x	1110	£260
XSDW0811	790 x	1110	£241
XSDW0611	590 x	1110	£219

*Available in all finishes including Accent colours

Code	Description	Price
Magnetic Name Plate/Label Holder - to fit MFC Screens only		
XSRLH	100mm wide (pack of 5). Supplied with acetate cover strips. Items stick to magnetic board below.	£33



Magnetic Board - to fit MFC Screens only		
XSDNP	230w x 320d magnetic board. Can be used with magnetic holders and name plate / label holder. Metalwork colour must be specified.	£64



Fabric Pin Board - to fit MFC Screens only		
XSFP08	800 x 300 high fabric pin board	£107
XSFP06	600 x 300 high fabric pin board. Band 1 screen fabric. Metalwork colour must be specified.	£96



A4 Tray - to fit MFC Screens only		
XSATRAY	A4 tray. Metalwork colour must be specified.	£66



Stationery Tray - to fit MFC Screens only		
XSSTRAY	Stationery tray. Metalwork colour must be specified.	£66



Phone Dock - to fit MFC Screens only		
XSPD	Holds mobile phone to screen. Metalwork colour must be specified.	£59



Tablet Dock - to fit MFC Screens only		
XSPDI	Holds tablet to screen. Metalwork colour must be specified.	£59



Screen Rail Pen Tray - to fit MFC Screens only		
XSPSP	Screen rail pencil slot. Metalwork colour must be specified.	£66



SCRIPT SYSTEM DESKING



Desking

- Script products are designed for clean-lined aesthetics and ease of use.
- Steel drawers are used for added functionality and strength.
- 600mm deep runners have 3/4 extension. 800mm deep runners have full extension on bottom drawer.
- Filing frames sold separately.

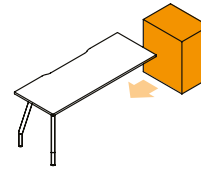

Code	W	D	MFC Price
------	---	---	-----------

443mm width - Single drawer

Replaces single fixed height leg as support on Add-on units

1XFPT8	443	x 800	£574
1XFPT6	443	x 600	£517



Code	W	D	MFC Price
------	---	---	-----------

343mm width - 2 deep drawers*

Replaces single fixed height leg as support on Add-on units

2XSFPT8	343	x 800	£522
2XSFPT6	343	x 600	£425



443mm width - 2 deep drawers*

Replaces single fixed height leg as support on Add-on units

2XFPT8	443	x 800	£522
2XFPT6	443	x 600	£425



343mm width - 2 shallow & 1 deep drawer*

Replaces single fixed height leg as support on Add-on units

3XSFPT8	343	x 800	£608
3XSFPT6	343	x 600	£503



443mm width - 2 shallow & 1 deep drawer*

Replaces single fixed height leg as support on Add-on units

3XFPT8	443	x 800	£608
3XFPT6	443	x 600	£503



343mm width - 4 shallow drawers

Replaces single fixed height leg as support on Add-on units

4XSFPT8	343	x 800	£640
4XSFPT6	343	x 600	£580



443mm width - 4 shallow drawers

Replaces single fixed height leg as support on Add-on units

4XFPT8	443	x 800	£640
4XFPT6	443	x 600	£580



*can accept filing frame. Filing frame sold separately.

10 Year
Guarantee

SCRIPT SYSTEM DESKING

Desking

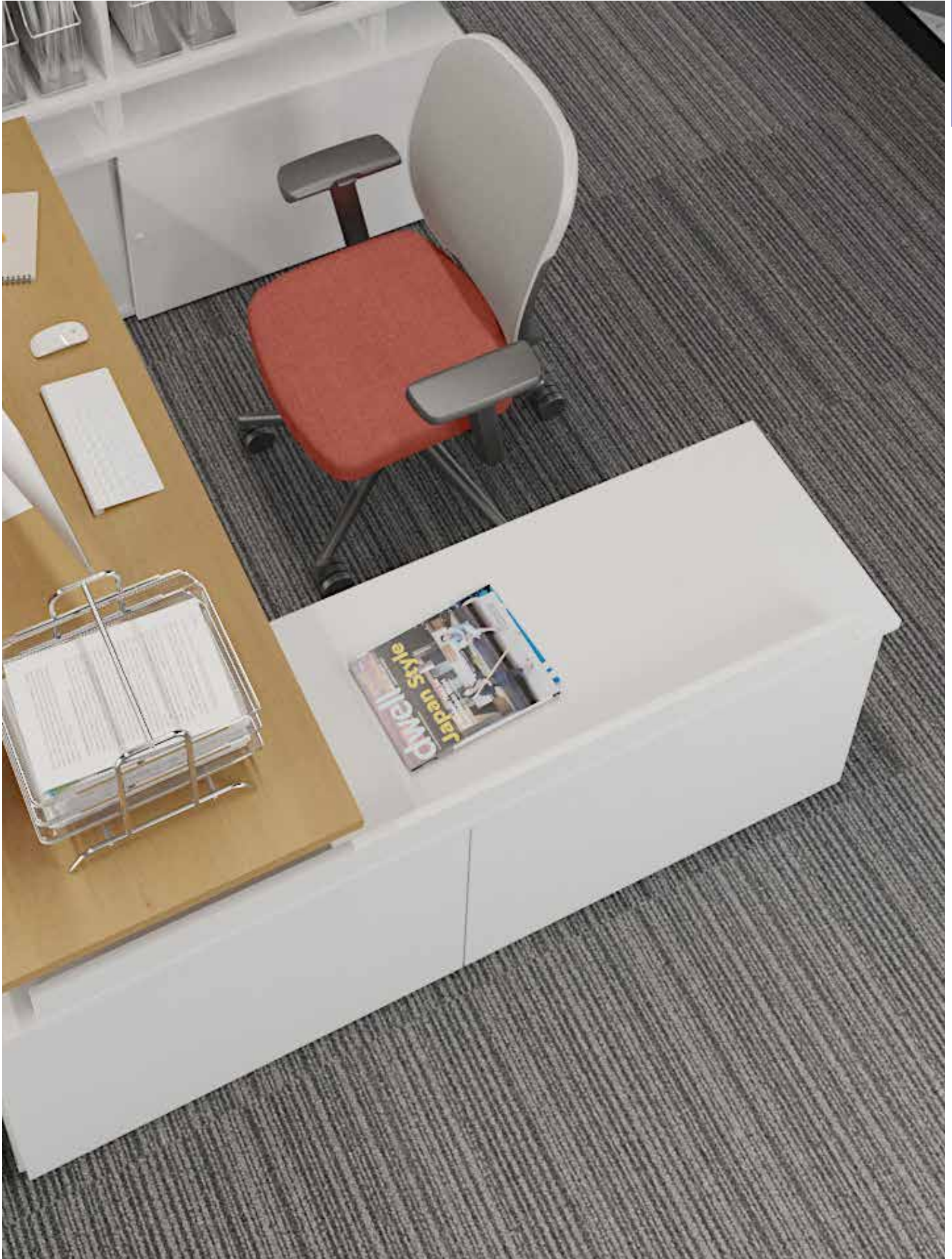

Rectangular Add-on Tops with Drop Height & Overhead Storage

SCRIPT SYSTEM DESKING



Desking

- Drop Height Pedestal creates pass through zone for electrics.
- Script pedestals have finger-pull drawer fronts and Steel System Drawers.
- Finished height including offset bracket 702mm.

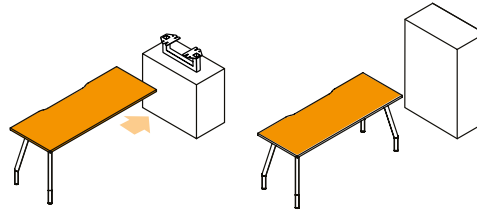

Code W D MFC Price

443mm width - 1 shallow drawer & 1 deep drawer*
Replaces single fixed height leg as support on Add-on units. Supplied with desk offset bracket.

2XFPTD8	443 x 800	£530
2XFPTD6	443 x 600	£478



443mm width - 3 shallow drawers

Replaces single fixed height leg as support on Add-on units. Supplied with desk offset bracket.

3XPTD8	443 x 800	£610
3XPTD6	443 x 600	£559



343mm width - 1 shallow drawer & 1 deep drawer*
Replaces single fixed height leg as support on Add-on units. Supplied with desk offset bracket.

2XSFPD8	343 x 800	£530
2XSFPD6	343 x 600	£478



343mm width - 3 shallow drawers

Replaces single fixed height leg as support on Add-on units. Supplied with desk offset bracket.

3XSPTD8	343 x 800	£610
3XSPTD6	343 x 600	£559



Single Drawer Tower Pedestal - 1110h x 443w
Sits adjacent or between desks

1XTOW8	443 x 800	£793
1XTOW6	443 x 600	£719

Script Steel Drawer Pedestal Accessories

Code Description Price

Pen Trays

SLPT04	416 retro fit pull out pen tray	£88
SLPT03	316 retro fit pull out pen tray	£88



TPT	Drop in pen tray fits slimline & full width	£22
-----	---	-----



Filing Frames

PEDFF84	800 deep x 416 wide	£37
PEDFF64	600 deep x 416 wide	£32
PEDFF83	800 deep x 316 wide	£37
PEDFF63	600 deep x 316 wide	£32



Drawer dividers

416DIV	416 divider for shallow drawer	£6
A4DIV	A4 partition	£6
A5DIV	A5 partition	£6
A6DIV	A6 partition	£6
A7DIV	A7 partition	£6

*can accept filing frame. Filing frame sold separately.



Rectangular Add-on Top and Add-on Desk with Drop Height Storage and Pedestal



- Creates cable pass-through zone
- Finished height including offset bracket 702mm.

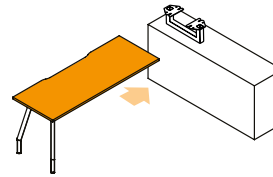

Code To fit MFC Price

Drop height Open fronted units

Replaces single fixed height leg as support on Add-on units. Supplied with offset bracket.



XDUB10	1000 deep	£411
XDUB08	800 deep	£355
XDUB06	600 deep	£314

1600mm x 434mm Drop height Open to upper and lower section

Supplied with desk offset bracket.



XDUBOF1610	1000 deep	£626
XDUBOF1608	800 deep	£620
XDUBOF1606	600 deep	£615

1600mm x 434mm Drop height Open to upper section, drawers to lower - locking

Supplied with desk offset bracket.



XDUBDR1610	1000 deep	£1,569
XDUBDR1608	800 deep	£1,564
XDUBDR1606	600 deep	£1,559

1600mm 434mm Drop height Full height hinged doors - locking

Supplied with offset bracket.



XDUBHD1610	1000 deep	£863
XDUBHD1608	800 deep	£858
XDUBHD1606	600 deep	£855

1600mm x 434mm double sliding wooden door - locking

Supplied with desk offset bracket.



XDUBS1610	1000 deep	£880
XDUBS1608	800 deep	£872
XDUBS1606	600 deep	£869

1600mm x 434mm single sliding wooden door - locking

Supplied with desk offset bracket



XDUBWS1610	1000 deep	£842
XDUBWS1608	800 deep	£836
XDUBWS1606	600 deep	£825

Structural Drop Height Accessories

Rear upstand, Infill top panels, Upholstered seat cushion & Pen tray.

Code Description MFC Price

Rear Upstand

XRU16	Fits to 1600 wide top	£32
-------	-----------------------	-----



Infill top panels -

Used with drop height units to create continuous worksurface.

XIT10	1600 x 434 infill top to fit 1000 top	£362
XIT08	1600 x 434 infill top to fit 800 top	£355
XIT06	1600 x 434 infill top to fit 600 top	£352



Upholstered seat cushion -

Fits to top of unit to provide perching area.

XUSC06	600 x 430 cushion to drop height top	
Band 1		£114
Band 2		£129
Band 3		£153
Band 4		£171
Band 5		£197
Band 6		£217
Band 7		£236



Price

Pull out pen tray -

Can be fitted to open sections of storage.

SLPT	Can be retro fitted (screw-on)	£55
------	--------------------------------	-----



SCRIPT SYSTEM DESKING

10 Year
Guarantee

Desking

Code **To fit** **MFC Price**

1600mm x 434mm drop height file drawer / Wooden sliding door combo - locking
Supplied with desk offset bracket, Drawer is lockable



Right hand unit shown



Right hand units

XDUF1610WR	1000 deep	£1,053
XDUF1608WR	800 deep	£1,045
XDUF1606WR	600 deep	£1,040

Left hand units

XDUF1610WL	1000 deep	£1,053
XDUF1608WL	800 deep	£1,045
XDUF1606WL	600 deep	£1,040



Rectangular Add-on Top & Structural Storage

BENCH² ACCESS TOP DESKING

10 Year
Guarantee

Deskings



Access Top

- Sliding top for cable tray access.
- Includes cable tray. Please specify bracket depth (increased or standard depth).
- Screens fitted independent of top.
- Accessories i.e. Monitor Arms and Power Modules clamp to rear.
- Can share end frame on back to back and side to side units resulting in cost effective solutions.

Angled leg not available on double sided add-on units.



Leg styles

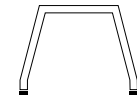

Angled leg prefix code with A

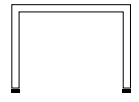

Straight leg

Starter Unit Code	MFC Price	Add-on unit Code	MFC Price	A	B
-------------------	-----------	------------------	-----------	---	---

Rectangular Desk 800mm deep

Intermediate end frames not available on single sided units.



BA2008Z	£782	BA2008AZ	£679	2000 x 800
BA1808Z	£769	BA1808AZ	£667	1800 x 800
BA1608Z	£758	BA1608AZ	£659	1600 x 800
BA1408Z	£750	BA1408AZ	£645	1400 x 800
BA1208Z	£723	BA1208AZ	£615	1200 x 800
BA1008Z	£700	BA1008AZ	£600	1000 x 800
BA0808Z	£688	BA0808AZ	£582	800 x 800

Rectangular Desk 600mm Deep

Intermediate end frames not available on single sided units.



BA2006Z	£706	BA2006AZ	£636	2000 x 600
BA1806Z	£697	BA1806AZ	£626	1800 x 600
BA1606Z	£690	BA1606AZ	£618	1600 x 600
BA1406Z	£676	BA1406AZ	£608	1400 x 600
BA1206Z	£670	BA1206AZ	£600	1200 x 600
BA1006Z	£660	BA1006AZ	£593	1000 x 600
BA0806Z	£645	BA0806AZ	£577	800 x 600

Rectangular Desk Double Sided 1600mm Deep

Intermediate end frames supplied with add-on back to back units.



BA2016Z	£1,254	BA2016AZ	£1,196	2000 x 1600
BA1816Z	£1,234	BA1816AZ	£1,173	1800 x 1600
BA1616Z	£1,216	BA1616AZ	£1,152	1600 x 1600
BA1416Z	£1,191	BA1416AZ	£1,131	1400 x 1600
BA1216Z	£1,147	BA1216AZ	£1,112	1200 x 1600
BA1016Z	£1,124	BA1016AZ	£1,088	1000 x 1600
BA0816Z	£1,104	BA0816AZ	£1,065	800 x 1600

Rectangular Desk Double Sided 1200mm Deep

Intermediate end frames supplied with add-on back to back units.



BA2012Z	£1,137	BA2012AZ	£1,041	2000 x 1200
BA1812Z	£1,120	BA1812AZ	£1,028	1800 x 1200
BA1612Z	£1,107	BA1612AZ	£1,020	1600 x 1200
BA1412Z	£1,087	BA1412AZ	£999	1400 x 1200
BA1212Z	£1,074	BA1212AZ	£984	1200 x 1200
BA1012Z	£1,059	BA1012AZ	£976	1000 x 1200
BA0812Z	£1,050	BA0812AZ	£962	800 x 1200

Starter Unit Code	MFC Price	Add-on unit Code	MFC Price	A	B	C
Double Wave Desking Single Sided						
Intermediate end frames not available on single sided units.						
BADW1808Z	£754	BADW1808AZ	£659	1800 x	600 x	800
BADW1608Z	£750	BADW1608AZ	£647	1600 x	600 x	800
BADW1810Z	£783	BADW1810AZ	£692	1800 x	800 x	1000
BADW1610Z	£771	BADW1610AZ	£679	1600 x	800 x	1000

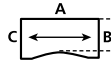

Starter Unit Code	MFC Price	Add-on unit Code	MFC Price	A	B	C
Double Wave Desking Double Sided						
Intermediate end frames supplied with add-on back to back units.						
BADW1816Z	£1,277	BADW1816AZ	£1,219	1800 x	1200 x	1600
BADW1616Z	£1,255	BADW1616AZ	£1,198	1600 x	1200 x	1600
BADW1820Z	£1,335	BADW1820AZ	£1,265	1800 x	1600 x	2000
BADW1620Z	£1,311	BADW1620AZ	£1,240	1600 x	1600 x	2000

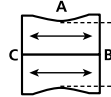

Access Top Double Wave Back to Back Desking with Angled Legs

BENCH² SCALLOP TOP RECTANGULAR DESKING



Desking



Scallop Top

- A variation on our popular Bench² Fixed Top.
- 45mm deep Scallop feature for cable access.
- Accessories are clamped to rear edge of top. Keeps worksurface free of cable ports.
- Accepts optional screens and cable trays.
- Can share end frame on back to back and side to side units resulting in cost effective solutions.



Leg styles

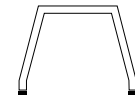

Angled leg prefix code with A

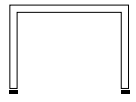

Straight leg

Angled leg not available on double sided add-on units.

Starter Unit Code	MFC Price	Add-on unit Code	MFC Price	A	B
Rectangular Desk 1000mm Deep					
Intermediate end frames not available on single sided units.					
BFS2010Z	£700	BFS2010AZ	£611	2000	x 1000
BFS1810Z	£694	BFS1810AZ	£606	1800	x 1000
BFS1610Z	£690	BFS1610AZ	£595	1600	x 1000
BFS1410Z	£676	BFS1410AZ	£580	1400	x 1000
BFS1210Z	£666	BFS1210AZ	£567	1200	x 1000
BFS1010Z	£659	BFS1010AZ	£553	1000	x 1000
BFS0810Z	£647	BFS0810AZ	£545	800	x 1000



Starter Unit Code	MFC Price	Add-on unit Code	MFC Price	A	B
Double Sided Rectangular Desk 2000mm Deep					
Intermediate end frames supplied with back to back add-on units.					
BFS2020Z	£1,164	BFS2020AZ	£1,088	2000	x 2000
BFS1820Z	£1,147	BFS1820AZ	£1,073	1800	x 2000
BFS1620Z	£1,125	BFS1620AZ	£1,054	1600	x 2000
BFS1420Z	£1,107	BFS1420AZ	£1,031	1400	x 2000
BFS1220Z	£1,085	BFS1220AZ	£1,009	1200	x 2000
BFS1020Z	£1,064	BFS1020AZ	£989	1000	x 2000
BFS0820Z	£1,050	BFS0820AZ	£970	800	x 2000



Starter Unit Code	MFC Price	Add-on unit Code	MFC Price	A	B
Rectangular Desk 800mm Deep					
Intermediate end frames not available on single sided units.					
BFS2008Z	£648	BFS2008AZ	£551	2000	x 800
BFS1808Z	£641	BFS1808AZ	£539	1800	x 800
BFS1608Z	£613	BFS1608AZ	£531	1600	x 800
BFS1408Z	£607	BFS1408AZ	£523	1400	x 800
BFS1208Z	£595	BFS1208AZ	£511	1200	x 800
BFS1008Z	£583	BFS1008AZ	£496	1000	x 800
BFS0808Z	£575	BFS0808AZ	£486	800	x 800



Starter Unit Code	MFC Price	Add-on unit Code	MFC Price	A	B
Double Sided Rectangular Desk 1600mm Deep					
Intermediate end frames supplied with back to back add-on units.					
BFS2016Z	£1,065	BFS2016AZ	£998	2000	x 1600
BFS1816Z	£1,053	BFS1816AZ	£980	1800	x 1600
BFS1616Z	£1,028	BFS1616AZ	£962	1600	x 1600
BFS1416Z	£1,014	BFS1416AZ	£945	1400	x 1600
BFS1216Z	£992	BFS1216AZ	£920	1200	x 1600
BFS1016Z	£968	BFS1016AZ	£900	1000	x 1600
BFS0816Z	£947	BFS0816AZ	£884	800	x 1600



Starter Unit Code	MFC Price	Add-on unit Code	MFC Price	A	B
Rectangular Desk 600mm Deep					
Intermediate end frames not available on single sided units.					
BFS2006Z	£577	BFS2006AZ	£504	2000	x 600
BFS1806Z	£569	BFS1806AZ	£496	1800	x 600
BFS1606Z	£559	BFS1606AZ	£488	1600	x 600
BFS1406Z	£551	BFS1406AZ	£482	1400	x 600
BFS1206Z	£537	BFS1206AZ	£469	1200	x 600
BFS1006Z	£530	BFS1006AZ	£454	1000	x 600
BFS0806Z	£520	BFS0806AZ	£445	800	x 600



Starter Unit Code	MFC Price	Add-on unit Code	MFC Price	A	B
Double Sided Rectangular Desk 1200mm Deep					
Intermediate end frames supplied with back to back add-on units.					
BFS2012Z	£951	BFS2012AZ	£873	2000	x 1200
BFS1812Z	£935	BFS1812AZ	£857	1800	x 1200
BFS1612Z	£916	BFS1612AZ	£838	1600	x 1200
BFS1412Z	£898	BFS1412AZ	£823	1400	x 1200
BFS1212Z	£873	BFS1212AZ	£796	1200	x 1200
BFS1012Z	£856	BFS1012AZ	£779	1000	x 1200
BFS0812Z	£837	BFS0812AZ	£763	800	x 1200



Scallop Top Rectangular Single Sided Desking with Angled Legs

BENCH² SCALLOP TOP WAVE DESKING

Starter Unit Code	MFC Price	Add-on unit Code	MFC Price	A	B	C
Right hand Wave Desk 800/1000mm						
Intermediate end frames not available on single sided units.						
BWSR1808Z	£662	BWSR1808AZ	£577	1800	800	1000
BWSR1608Z	£658	BWSR1608AZ	£568	1600	800	1000
BWSR1408Z	£645	BWSR1408AZ	£554	1400	800	1000
BWSR1208Z	£638	BWSR1208AZ	£539	1200	800	1000

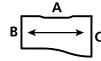

Starter Unit Code	MFC Price	Add-on unit Code	MFC Price	A	B	C
Double Wave Desk						
Intermediate end frames not available on single sided units.						
BFSDW1808Z	£662	BFSDW1808AZ	£577	1800	600	800
BFSDW1608Z	£658	BFSDW1608AZ	£568	1600	600	800
BFSDW1810Z	£719	BFSDW1810AZ	£624	1800	800	1000
BFSDW1610Z	£703	BFSDW1610AZ	£615	1600	800	1000

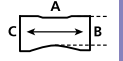

Starter Unit Code	MFC Price	Add-on unit Code	MFC Price	A	B	C
Left hand Wave Desk 800/1000mm						
Intermediate end frames not available on single sided units.						
BWSL1808Z	£662	BWSL1808AZ	£577	1800	800	1000
BWSL1608Z	£658	BWSL1608AZ	£568	1600	800	1000
BWSL1408Z	£645	BWSL1408AZ	£554	1400	800	1000
BWSL1208Z	£638	BWSL1208AZ	£539	1200	800	1000

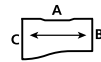

Starter Unit Code	MFC Price	Add-on unit Code	MFC Price	A	B	C
Double Wave Double Sided Desk Back to Back						
Intermediate end frames supplied with back to back add-on units.						
BFSDW1816Z	£1,091	BFSDW1816AZ	£1,024	1800	1200	1600
BFSDW1616Z	£1,075	BFSDW1616AZ	£1,000	1600	1200	1600
BFSDW1820Z	£1,189	BFSDW1820AZ	£1,115	1800	1600	2000
BFSDW1620Z	£1,167	BFSDW1620AZ	£1,095	1600	1600	2000

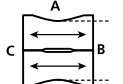

Starter Unit Code	MFC Price	Add-on unit Code	MFC Price	A	B	C
Right hand Wave Desk 600/800mm						
Intermediate end frames not available on single sided units.						
BWSR1806Z	£641	BWSR1806AZ	£559	1800	600	800
BWSR1606Z	£635	BWSR1606AZ	£550	1600	600	800
BWSR1406Z	£624	BWSR1406AZ	£536	1400	600	800
BWSR1206Z	£615	BWSR1206AZ	£529	1200	600	800

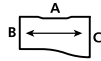

Starter Unit Code	MFC Price	Add-on unit Code	MFC Price	A	B	C
Double Sided Wave Desk 600/800mm Back to Back						
Intermediate end frames supplied with back to back add-on units.						
BWSC1816Z	£1,027	BWSC1816AZ	£979	1800	1600	1200
BWSC1616Z	£1,012	BWSC1616AZ	£962	1600	1600	1200
BWSC1416Z	£997	BWSC1416AZ	£948	1400	1600	1200
BWSC1216Z	£979	BWSC1216AZ	£945	1200	1600	1200

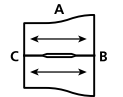

Starter Unit Code	MFC Price	Add-on unit Code	MFC Price	A	B	C
Left hand Wave Desk 600/800mm						
Intermediate end frames not available on single sided units.						
BWSL1806Z	£641	BWSL1806AZ	£559	1800	600	800
BWSL1606Z	£635	BWSL1606AZ	£550	1600	600	800
BWSL1406Z	£624	BWSL1406AZ	£536	1400	600	800
BWSL1206Z	£615	BWSL1206AZ	£529	1200	600	800

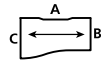

Starter Unit Code	MFC Price	Add-on unit Code	MFC Price	A	B	C
Double Sided Wave Desk 800/1000mm Back to Back						
Intermediate end frames supplied with back to back add-on units.						
BWSC1820Z	£1,091	BWSC1820AZ	£1,024	1800	2000	1600
BWSC1620Z	£1,075	BWSC1620AZ	£1,000	1600	2000	1600
BWSC1420Z	£1,055	BWSC1420AZ	£988	1400	2000	1600
BWSC1220Z	£1,031	BWSC1220AZ	£968	1200	2000	1600

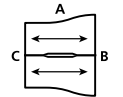

Scallop Top Back to Back Rectangular Desks with Angled Legs

BENCH² SCALLOP TOP DESKING



Desking



Scallop Top

- A variation on our popular Bench² Fixed Top.
- 45mm deep Scallop feature for cable access.
- Accessories are clamped to rear edge of top. Keeps worksurface free of cable ports.
- Accepts optional screens and cable trays.
- Can share end frame on back to back and side to side units resulting in cost effective solutions.



Leg styles

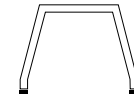

Angled leg prefix code with A



Straight leg

Angled leg not available on double sided add-on units.

Starter Unit Code	MFC Price	Add-on unit Code	MFC Price
-------------------	-----------	------------------	-----------

Right Handed - Angular Desking

Intermediate end frames not available on single sided units.

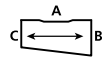

BFSAR1806Z	£641	BFSAR1806AZ	£559
BFSAR1808Z	£662	BFSAR1808AZ	£577

A	B	C
1800 x	800 x	600
1800 x	1000 x	800

Workstation Back to Back Cluster

Code	A	B	C	D	MFC Price
BUSC1824Z	1800	x 1600	x 600	x 2400	£1,627
BUSC1624Z	1600	x 1600	x 600	x 2400	£1,607
BUSC1424Z	1400	x 1600	x 600	x 2400	£1,595

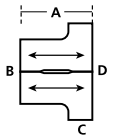

Left Handed - Angular Desking

Intermediate end frames not available on single sided units.

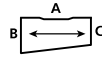

BFSAL1806Z	£641	BFSAL1806AZ	£559
BFSAL1808Z	£662	BFSAL1808AZ	£577

A	B	C
1800 x	800 x	600
1800 x	1000 x	800

Workstation 4 Way Cluster

Code	A	B	C	D	MFC Price
BUSC3624Z	3600	x 1600	x 1200	x 2400	£2,813
BUSC3224Z	3200	x 1600	x 1200	x 2400	£2,763
BUSC2824Z	2800	x 1600	x 1200	x 2400	£2,743

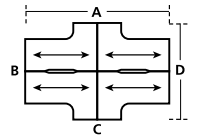

Double Sided Angular Desking

Intermediate end frames supplied with back to back add-on units.

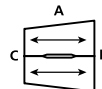

BFSAC1812Z	£1,027	BFSAC1812AZ	£979
BFSAC1816Z	£1,091	BFSAC1816AZ	£1,024

A	B	C
1800 x	1600 x	1200
1800 x	2000 x	1600

120° Symmetrical Workstation

BSSW1208Z	1200	x 800	x 800	x 1200	£862
BSSW1206Z	1200	x 600	x 600	x 1200	£831
BSSW1006Z	1000	x 600	x 600	x 1000	£817

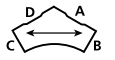

Right Handed - Angular Conference Desk

Intermediate end frames not available on single sided units.

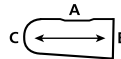

BFSAR22DZ	£753	BFSAR22DAZ	£666
-----------	------	------------	------

A	B
2200 x	1000 x
2200 x	800

120° 3 Way Workstation Cluster

BSSWC1216Z	1200	x 800	x 800	x 1200	£2,146
BSSWC1212Z	1200	x 600	x 600	x 1200	£2,078
BSSWC1012Z	1000	x 600	x 600	x 1000	£2,026

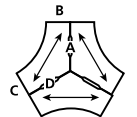

Intermediate end frames not available on single sided units.

BFSAL22DZ	£753	BFSAL22DAZ	£666
-----------	------	------------	------

A	B
2200 x	1000 x
2200 x	800



Scallop Top Double Sided with Angled Legs

BENCH² SCALLOP TOP DESKING

Code A B C D MFC Price

Right Hand - Workstation

BUSR1812Z	1800	x 800	x 600	x 1200	
BUSR1612Z	1600	x 800	x 600	x 1200	
BUSR1412Z	1400	x 800	x 600	x 1200	

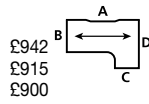

£942
£915
£900

Code A B MFC Price

800mm Fixed top return units - To suit 800 deep only

BRSU126Z	1200	x 600		
BRSU106Z	1000	x 600		
BRSU086Z	800	x 600		

£504
£491
£485

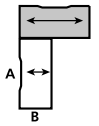

Left Hand - Workstation

BUSL1812Z	1800	x 800	x 600	x 1200	
BUSL1612Z	1600	x 800	x 600	x 1200	
BUSL1412Z	1400	x 800	x 600	x 1200	

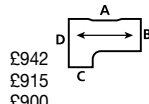

£942
£915
£900

Workstation Side to Side Cluster Shared 1200mm Endframe

BUSC3612Z	3600	x 800	x 1200	x 1200	
BUSC3212Z	3200	x 800	x 1200	x 1200	
BUSC2812Z	2800	x 800	x 1200	x 1200	

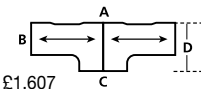

£1,607
£1,588
£1,577



Scallop Top Double Wave Back to Back Desking with Straight Legs

BENCH² FIXED TOP RECTANGULAR DESKING

10 Year Guarantee

Desking



Fixed Top

- Cable access via cable ports.
- Accepts optional cable tray.
- Accessories i.e. Screens and Monitor Arms are fixed to the top via a cable port.
- Can share end frame on back to back and side to side units resulting in cost effective solutions.



Leg styles

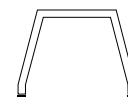

Angled leg prefix code with A

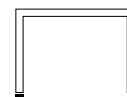

Straight leg

Angled leg not available on double sided add-on units.

Starter Unit Code	MFC Price	Add-on unit Code	MFC Price	A	B
Rectangular Desk 1000mm Deep					
Intermediate end frames not available on single sided units.					
BF2010Z	£700	BF2010AZ	£611	2000	1000
BF1810Z	£694	BF1810AZ	£606	1800	1000
BF1610Z	£690	BF1610AZ	£595	1600	1000
BF1410Z	£676	BF1410AZ	£580	1400	1000
BF1210Z	£666	BF1210AZ	£567	1200	1000
BF1010Z	£659	BF1010AZ	£553	1000	1000
BF0810Z	£647	BF0810AZ	£545	800	1000

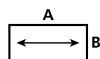

Starter Unit Code	MFC Price	Add-on unit Code	MFC Price	A	B
Double Sided Rectangular Desk 2000mm Deep					
Intermediate end frames supplied with back to back add-on units.					
BF2020Z	£1,164	BF2020AZ	£1,088	2000	2000
BF1820Z	£1,147	BF1820AZ	£1,073	1800	2000
BF1620Z	£1,125	BF1620AZ	£1,054	1600	2000
BF1420Z	£1,107	BF1420AZ	£1,031	1400	2000
BF1220Z	£1,085	BF1220AZ	£1,009	1200	2000
BF1020Z	£1,064	BF1020AZ	£989	1000	2000
BF0820Z	£1,050	BF0820AZ	£970	800	2000

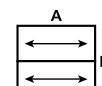

Starter Unit Code	MFC Price	Add-on unit Code	MFC Price	A	B
Rectangular Desk 800mm Deep					
Intermediate end frames not available on single sided units.					
BF2008Z	£648	BF2008AZ	£551	2000	800
BF1808Z	£641	BF1808AZ	£539	1800	800
BF1608Z	£613	BF1608AZ	£531	1600	800
BF1408Z	£607	BF1408AZ	£523	1400	800
BF1208Z	£595	BF1208AZ	£511	1200	800
BF1008Z	£583	BF1008AZ	£496	1000	800
BF0808Z	£575	BF0808AZ	£486	800	800

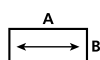

Starter Unit Code	MFC Price	Add-on unit Code	MFC Price	A	B
Double Sided Rectangular Desk 1600mm Deep					
Intermediate end frames supplied with back to back add-on units.					
BF2016Z	£1,065	BF2016AZ	£998	2000	1600
BF1816Z	£1,053	BF1816AZ	£980	1800	1600
BF1616Z	£1,028	BF1616AZ	£962	1600	1600
BF1416Z	£1,014	BF1416AZ	£945	1400	1600
BF1216Z	£992	BF1216AZ	£920	1200	1600
BF1016Z	£968	BF1016AZ	£900	1000	1600
BF0816Z	£947	BF0816AZ	£884	800	1600

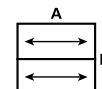

Starter Unit Code	MFC Price	Add-on unit Code	MFC Price	A	B
Rectangular Desk 600mm Deep					
Intermediate end frames not available on single sided units.					
BF2006Z	£577	BF2006AZ	£504	2000	600
BF1806Z	£569	BF1806AZ	£496	1800	600
BF1606Z	£559	BF1606AZ	£488	1600	600
BF1406Z	£551	BF1406AZ	£482	1400	600
BF1206Z	£537	BF1206AZ	£469	1200	600
BF1006Z	£530	BF1006AZ	£454	1000	600
BF0806Z	£520	BF0806AZ	£445	800	600



Starter Unit Code	MFC Price	Add-on unit Code	MFC Price	A	B
Double Sided Rectangular Desk 1200mm Deep					
Intermediate end frames supplied with back to back add-on units.					
BF2012Z	£951	BF2012AZ	£873	2000	1200
BF1812Z	£935	BF1812AZ	£857	1800	1200
BF1612Z	£916	BF1612AZ	£838	1600	1200
BF1412Z	£898	BF1412AZ	£823	1400	1200
BF1212Z	£873	BF1212AZ	£796	1200	1200
BF1012Z	£856	BF1012AZ	£779	1000	1200
BF0812Z	£837	BF0812AZ	£763	800	1200

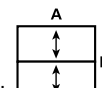

10 Year
Guarantee

BENCH² FIXED TOP RECTANGULAR DESKING

Desking

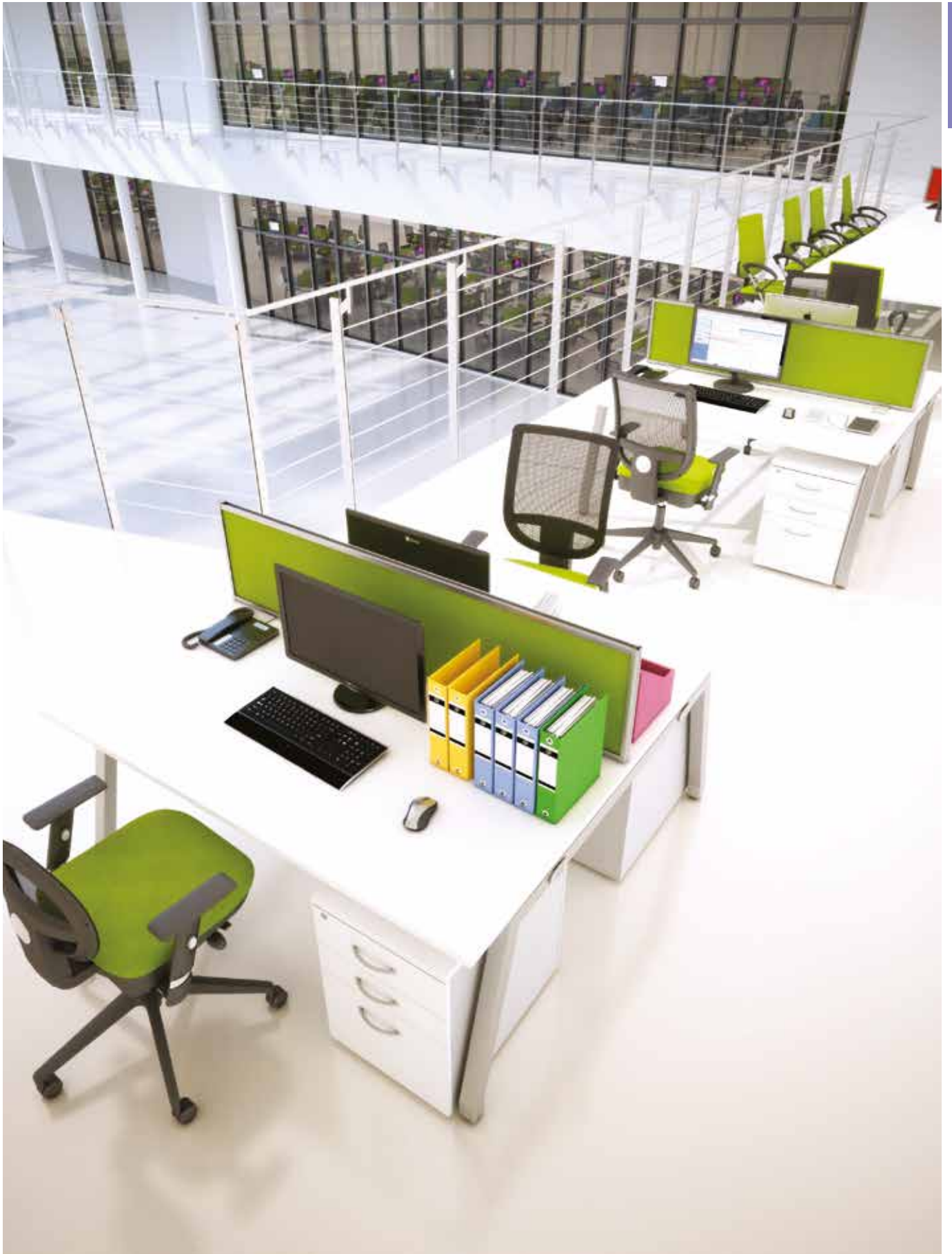

Fixed Top Rectangular Back to Back Desking with Angled Legs

BENCH² FIXED TOP WAVE DESKING



Desking



Fixed Top

- Cable access via cable ports.
- Accepts optional cable tray.
- Accessories i.e. Screens and Monitor Arms are fixed to the top via a cable port.
- Can share end frame on back to back and side to side units resulting in cost effective solutions.



Leg styles

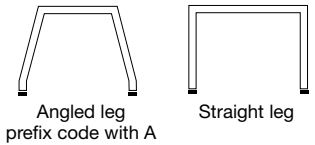

Angled leg not available on double sided add-on units.

Starter Unit Code	MFC Price	Add-on unit Code	MFC Price	A	B	C
Right hand Wave Desk 600/800mm						
Intermediate end frames not available on single sided units.						
BWR1806Z	£641	BWR1806AZ	£559	1800	600	800
BWR1606Z	£635	BWR1606AZ	£550	1600	600	800
BWR1406Z	£624	BWR1406AZ	£536	1400	600	800
BWR1206Z	£615	BWR1206AZ	£529	1200	600	800

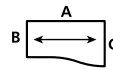

Starter Unit Code	MFC Price	Add-on unit Code	MFC Price	A	B	C
Double Sided Wave Desk 600/800mm Back to Back						
Intermediate end frames supplied with back to back add-on units.						
BWC1816Z	£1,027	BWC1816AZ	£979	1800	1600	1200
BWC1616Z	£1,012	BWC1616AZ	£962	1600	1600	1200
BWC1416Z	£997	BWC1416AZ	£948	1400	1600	1200
BWC1216Z	£979	BWC1216AZ	£945	1200	1600	1200

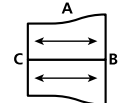

Starter Unit Code	MFC Price	Add-on unit Code	MFC Price	A	B	C
Left hand Wave Desk 600/800mm						
Intermediate end frames not available on single sided units.						
BWL1806Z	£641	BWL1806AZ	£559	1800	600	800
BWL1606Z	£635	BWL1606AZ	£550	1600	600	800
BWL1406Z	£624	BWL1406AZ	£536	1400	600	800
BWL1206Z	£615	BWL1206AZ	£529	1200	600	800

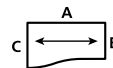

Starter Unit Code	MFC Price	Add-on unit Code	MFC Price	A	B	C
Double Sided Wave Desk 800/1000mm Back to Back						
Intermediate end frames supplied with back to back add-on units.						
BWC1820Z	£1,091	BWC1820AZ	£1,024	1800	2000	1600
BWC1620Z	£1,075	BWC1620AZ	£1,000	1600	2000	1600
BWC1420Z	£1,055	BWC1420AZ	£988	1400	2000	1600
BWC1220Z	£1,031	BWC1220AZ	£968	1200	2000	1600

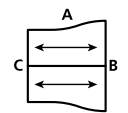

Starter Unit Code	MFC Price	Add-on unit Code	MFC Price	A	B	C
Right hand Wave Desk 800/1000mm						
Intermediate end frames not available on single sided units.						
BWR1808Z	£662	BWR1808AZ	£577	1800	800	1000
BWR1608Z	£658	BWR1608AZ	£568	1600	800	1000
BWR1408Z	£645	BWR1408AZ	£554	1400	800	1000
BWR1208Z	£638	BWR1208AZ	£539	1200	800	1000

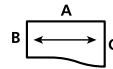

Starter Unit Code	MFC Price	Add-on unit Code	MFC Price	A	B	C
Double Wave Desk						
Intermediate end frames not available on single sided units.						
BFDW1808Z	£662	BFDW1808AZ	£577	1800	600	800
BFDW1608Z	£658	BFDW1608AZ	£568	1600	600	800
BFDW1810Z	£719	BFDW1810AZ	£624	1800	800	1000
BFDW1610Z	£703	BFDW1610AZ	£615	1600	800	1000

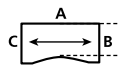

Starter Unit Code	MFC Price	Add-on unit Code	MFC Price	A	B	C
Left hand Wave Desk 800/1000mm						
Intermediate end frames not available on single sided units.						
BWL1808Z	£662	BWL1808AZ	£577	1800	800	1000
BWL1608Z	£658	BWL1608AZ	£568	1600	800	1000
BWL1408Z	£645	BWL1408AZ	£554	1400	800	1000
BWL1208Z	£638	BWL1208AZ	£539	1200	800	1000

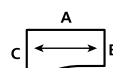

Starter Unit Code	MFC Price	Add-on unit Code	MFC Price	A	B	C
Double Wave Double Sided Desk Back to Back						
Intermediate end frames supplied with back to back add-on units.						
BFDW1816Z	£1,091	BFDW1816AZ	£1,024	1800	1200	1600
BFDW1616Z	£1,075	BFDW1616AZ	£1,000	1600	1200	1600
BFDW1820Z	£1,189	BFDW1820AZ	£1,115	1800	1600	2000
BFDW1620Z	£1,167	BFDW1620AZ	£1,095	1600	1600	2000

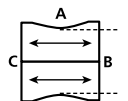

Single Sided Fixed Top Wave Desk with Straight Legs

10 Year
Guarantee

BENCH² FIXED TOP WAVE DESKING

Desking



Double Wave Back to Back Desking with Straight Legs

BENCH² FIXED TOP DESKING



Desking



Fixed Top

- Cable access via cable ports.
- Accepts optional cable tray.
- Accessories i.e. Screens and Monitor Arms are fixed to the top via a cable port.
- Can share end frame on back to back and side to side units resulting in cost effective solutions.



Leg styles

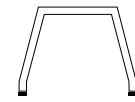

Angled leg
prefix code with A

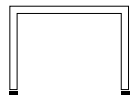

Straight leg

Angled leg not available on double sided add-on units.

Starter Unit Code	MFC Price	Add-on unit Code	MFC Price
-------------------	-----------	------------------	-----------

Right Handed - Angular Desking

Intermediate end frames not available on single sided units.

BFAR1806Z	£641	BFAR1806AZ	£559
BFAR1808Z	£662	BFAR1808AZ	£577

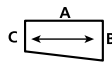

Left Handed - Angular Desking

Intermediate end frames not available on single sided units.

BFAL1806Z	£641	BFAL1806AZ	£559
BFAL1808Z	£662	BFAL1808AZ	£577

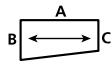

Double Sided Angular Desking

Intermediate end frames supplied with back to back add-on units.

BFAC1812Z	£1,027	BFAC1812AZ	£979
BFAC1816Z	£1,091	BFAC1816AZ	£1,024

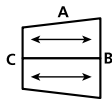

Right Handed - Angular Conference Desk

Intermediate end frames not available on single sided units.

BFAR22DZ	£753	BFAR22DAZ	£666
----------	------	-----------	------

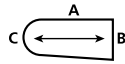

Left Handed - Angular Conference Desk

Intermediate end frames not available on single sided units.

BFAL22DZ	£753	BFAL22DAZ	£666
----------	------	-----------	------

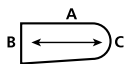

Workstation Back to Back Cluster

Code	A	B	C	D	MFC Price
BUC1824Z	1800	x 1600	x 600	x 2400	£1,627
BUC1624Z	1600	x 1600	x 600	x 2400	£1,607
BUC1424Z	1400	x 1600	x 600	x 2400	£1,595

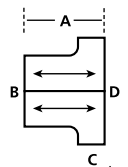

Workstation 4 Way Cluster

BUC3624Z	3600	x 1600	x 1200	x 2400	£2,813
BUC3224Z	3200	x 1600	x 1200	x 2400	£2,763
BUC2824Z	2800	x 1600	x 1200	x 2400	£2,743

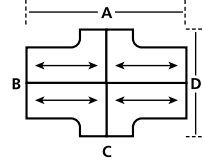

120° Symmetrical Workstation

BSW1208Z	1200	x 800	x 800	x 1200	£862
BSW1206Z	1200	x 600	x 600	x 1200	£831
BSW1006Z	1000	x 600	x 600	x 1000	£817

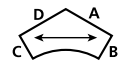

120° 3 Way Workstation Cluster

BSWC1216Z	1200	x 800	x 800	x 1200	£2,146
BSWC1212Z	1200	x 600	x 600	x 1200	£2,078
BSWC1012Z	1000	x 600	x 600	x 1000	£2,026

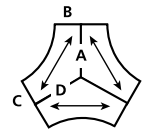

Code	A	B	C	D	MFC Price
------	---	---	---	---	-----------

Right Hand - Workstation

BUR1812Z	1800	x 800	x 600	x 1200	£942
BUR1612Z	1600	x 800	x 600	x 1200	£915
BUR1412Z	1400	x 800	x 600	x 1200	£900

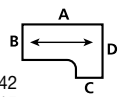

Left Hand - Workstation

BUL1812Z	1800	x 800	x 600	x 1200	£942
BUL1612Z	1600	x 800	x 600	x 1200	£915
BUL1412Z	1400	x 800	x 600	x 1200	£900

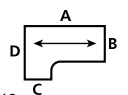

Workstation Side to Side Cluster Shared 1200mm Endframe

BUC3612Z	3600	x 800	x 1200	x 1200	£1,607
BUC3212Z	3200	x 800	x 1200	x 1200	£1,588
BUC2812Z	2800	x 800	x 1200	x 1200	£1,577

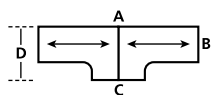

Code	A	B	MFC Price
------	---	---	-----------

800mm Fixed top return units - To suit 800 deep only

BRU126Z	1200	x 600	£504
BRU106Z	1000	x 600	£491
BRU086Z	800	x 600	£485

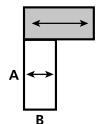

10 Year
Guarantee

BENCH² FIXED TOP DESKING

Desking



Fixed Top Single Angular Desk with Straight Legs

BENCH² HEIGHT ADJUSTABLE DESKING

10 Year
Guarantee

Deskings

- Manual operated with removable handle.
- Fits to all legs - both front & rear.
- Cable spines are available for vertical cable management rise & fall.
- Can be used with under desk pedestals (except 600mm deep desks).

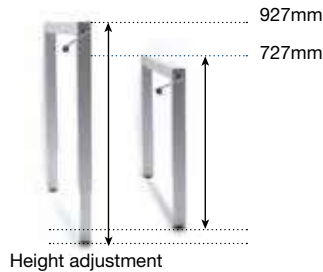

Maximum Load
Per Top (evenly distributed)

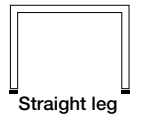

Code A B C MFC Price

800mm Deep Rectangular Desking

BFH1808	1800 x	800		£1,688
BFH1608	1600 x	800		£1,653
BFH1408	1400 x	800		£1,641
BFH1208	1200 x	800		£1,622
BFH1008	1000 x	800		£1,614
BFH0808	800 x	800		£1,592

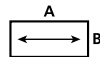

600mm Deep Rectangular Desking

BFH1806	1800 x	600		£1,617
BFH1606	1600 x	600		£1,604
BFH1406	1400 x	600		£1,589
BFH1206	1200 x	600		£1,571
BFH1006	1000 x	600		£1,559
BFH0806	800 x	600		£1,537



Right Hand 800mm Deep Wave Desking

BFHWR188	1800 x	800 x	1000	£1,706
BFHWR168	1600 x	800 x	1000	£1,696
BFHWR148	1400 x	800 x	1000	£1,679
BFHWR128	1200 x	800 x	1000	£1,667

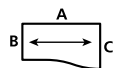

Left Hand 800mm Deep Wave Desking

BFHWL188	1800 x	800 x	1000	£1,706
BFHWL168	1600 x	800 x	1000	£1,696
BFHWL148	1400 x	800 x	1000	£1,679
BFHWL128	1200 x	800 x	1000	£1,667

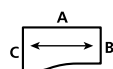

Right Hand 600mm Deep Wave Desking

BFHWR186	1800 x	600 x	800	£1,693
BFHWR166	1600 x	600 x	800	£1,675
BFHWR146	1400 x	600 x	800	£1,665
BFHWR126	1200 x	600 x	800	£1,651

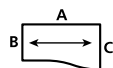

Left Hand 600mm Deep Wave Desking

BFHWL186	1800 x	600 x	800	£1,693
BFHWL166	1600 x	600 x	800	£1,675
BFHWL146	1400 x	600 x	800	£1,665
BFHWL126	1200 x	600 x	800	£1,651

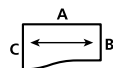

Double Wave Desking

BFHDW186Z	1800 x	600 x	800	£1,693
BFHDW166Z	1600 x	600 x	800	£1,675

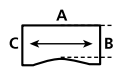

Code A B C MFC Price

Right hand Angular Desking

BFHAR188	1800 x	1000 x	800	£1,706
BFHAR186	1800 x	800 x	600	£1,693

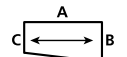

Left Hand Angular Desking

BFHAL188	1800 x	1000 x	800	£1,706
BFHAL186	1800 x	800 x	600	£1,693

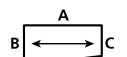

Right Hand Angular Conference Desking

BFHAR228	2200 x	1000 x	800	£1,795
----------	--------	--------	-----	--------

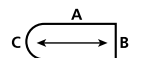

Left Hand Angular Conference Desking

BFHAL228	2200 x	1000 x	800	£1,795
----------	--------	--------	-----	--------

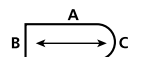

10 Year
Guarantee

BENCH² HEIGHT ADJUSTABLE DESKING

Deskling



Height Adjustable Rectangular Desks

BENCH² ACCESSORIES

DESKING



Desking

Code W D H MFC Price

Single Sided Over Desk Shelving

Fits to Fixed Top, Scallop Top
(used on single sided desks).



BTSS20Z	2000	x	300	x	420	£265
BTSS18Z	1800	x	300	x	420	£245
BTSS16Z	1600	x	300	x	420	£219
BTSS14Z	1400	x	300	x	420	£198
BTSS12Z	1200	x	300	x	420	£174
BTSS10Z	1000	x	300	x	420	£156
BTSS08Z	800	x	300	x	420	£141



Code W H Desk Size MFC Price

Suspended Modesty Panels

Fits to rear side of single Fixed Top
and Scallop Top desking only.



BTCPW20	1826	x	250	2000	£102
BTCPW18	1626	x	250	1800	£98
BTCPW16	1426	x	250	1600	£92
BTCPW14	1226	x	250	1400	£86
BTCPW12	1026	x	250	1200 & 120°	£76
BTCPW10	826	x	250	1000 & 120°	£73
BTCPW08	626	x	250	800	£68



Double Sided Over Desk Shelving

Fits to Fixed Top, Scallop Top
(used on back to back desks).



BTDS20Z	2000	x	600	x	420	£346
BTDS18Z	1800	x	600	x	420	£316
BTDS16Z	1600	x	600	x	420	£284
BTDS14Z	1400	x	600	x	420	£255
BTDS12Z	1200	x	600	x	420	£225
BTDS10Z	1000	x	600	x	420	£202
BTDS08Z	800	x	600	x	420	£185



Infill End Frames - Complete Units

Fits On Straight Frame Only

Supplementary price, must be specified at point of order.



BECP20	2000	Shared	£330
BECP16	1600	Shared	£309
BECP12	1200	Shared	£250
BECP10	1000		£218
BECP08	800		£192
BECP06	600		£180



Height Adjustable Kit Fitting To Bench² Underframe

AVAILABLE ON ACCESS TOP.
AVAILABLE ON FIXED & SCALLOP TOP WHEN DESK MOUNTED SCREENS ARE NOT USED.

Manually selective to fixed positions. Height adjustment between 727 & 827mm in 20mm increments.
Kits raise a single work surface to the desired height and can be ordered with desks or retro-fitted to existing units.
They can be fitted to stand alone desks or to units within clusters without affecting existing cable management or screens.

Code	To fit desk	Price
BRHA10	1000mm deep rectangular desks	£104
BRHA08	800mm deep rectangular desks & 800/1000mm deep wave & angular desks	£102
BRHA06	600mm deep rectangular desks & 600/800mm deep wave & angular desks	£100

Bench Code A B Price

Circular Conference End

Add-on for 800mm Deep Rectangular Desking.

BFCE12Z	800	x	Ø1200	£645
---------	-----	---	-------	------



Tear Drop Conference End

Circular Conference End

Add-on for 800mm Deep Rectangular Desking.

BFTE12Z	800	x	Ø1200	£733
---------	-----	---	-------	------



Circular Conference End

Circular End Tables

Add-on for 1600mm/1200mm Deep Rectangular Desking.

BFTSC16Z	Ø1600	x	800	£667
BFTSC12Z	Ø1200	x	600	£667



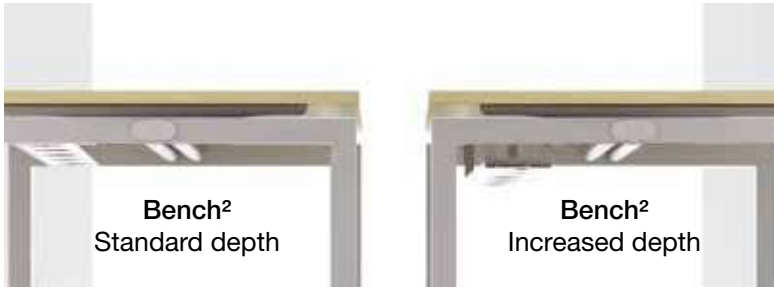

Information - Cable tray positions

All Bench Squared cable trays come complete with brackets that cater for most cabling requirements.

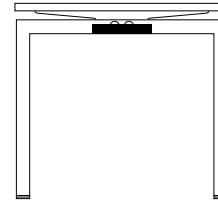

Standard depth 75mm

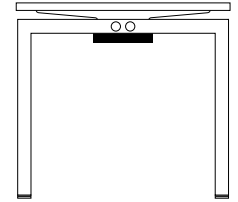

Increased depth 130mm

Cable trays are sold as standard with Access Top and as optional extras to Fixed & Scallop Top desking. They need only be specified where required for Fixed and Scallop Top. Depth of brackets must be specified for all Bench² cable trays including Access Top. Cable risers and spines fit to Access, Fixed & Scallop Top desking.

Please note: Only 555 High under desk pedestals fit underneath increased depth cable trays.



Code	Where Used	Price
------	------------	-------

Cable Trays - Fixed Top Desking Double Sided

Complete with brackets, for increased depth brackets Suffix code with - I

BFCT20D	2000mm desk	£159
BFCT18D	1800mm desk & workstation	£148
BFCT16D	1600mm desk & workstation	£146
BFCT14D	1400mm desk & workstation	£142
BFCT12D	1200mm desk	£124
BFCT10D	1000mm desk	£121
BFCT10D-3	1200mm 120° workstation	£121
BFCT08D-3	1000mm 120° workstation	£118
BFCT08D	800mm desk	£118

Double sided cable tray



Cable Trays - Fixed Top Desking Single Sided

Complete with brackets, for increased depth brackets Suffix code with - I

BFCT20S	2000mm desk	£102
BFCT18S	1800mm desk & workstation	£96
BFCT16S	1600mm desk & workstation	£92
BFCT14S	1400mm desk & workstation	£89
BFCT12S	1200mm desk	£78
BFCT10S	1000mm desk	£74
BFCT10S-3	1200mm 120° workstation	£74
BFCT08S-3	1000mm 120° workstation	£71
BFCT08S	800mm desk	£71

Single sided cable tray



Cable Trays - End Caps

Optional items used to blank off ends of run trays - Used with increased depth cable trays

BCTECD	Double sided - increased depth cable trays	£55
BCTECS	Single sided - increased depth cable trays	£55



Cable tray end caps

Cable Riser, Cable Spines & Suspended CPU Holders

Fits to Access, Fixed & Scallop Top desking. BUPUH1 Fits to Bench² spines at any point.

BFCR	For use with Standard depth cable trays	£107
BFCL	For use with Increased depth cable trays	£107
BCRB	Cable spine (Black)	£82
BCRS	Cable spine (Silver)	£82
BCRW	Cable spine (White)	£82
BCPUH1	To suit CPU up to 90w x 290h - 240w x 510h	£229
BCPUHA	Infinitely adjustable with Allen key Adaptor bracket - used when CPU holder is fitted to desks with increased depth cable trays	£40



BFCR



BCRS



BCPUH1

MESA & MESA PLUS DESKING

10 Year
Guarantee

Desking

Mesa and Mesa Plus are stripped-back Bench desking ranges that combine strength with ease of assembly and use. Both feature 45mm scalloped tops for cable access and shared componentry for cost effective cluster solutions. Two distinct leg versions are available for Mesa and Mesa Plus.



Leg styles

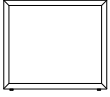

Codi leg prefix
code with C

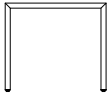

Straight leg

Codi leg not available on double sided add-on units.

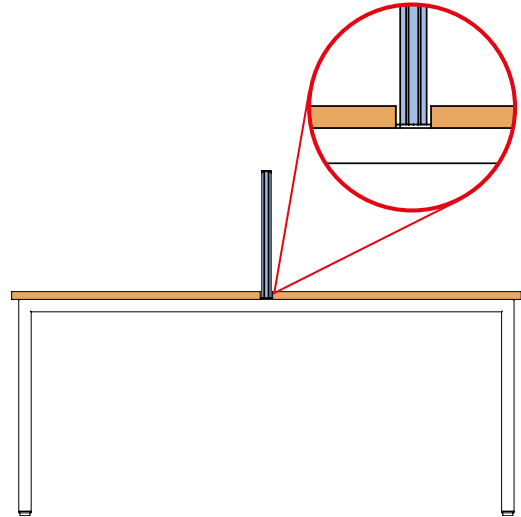
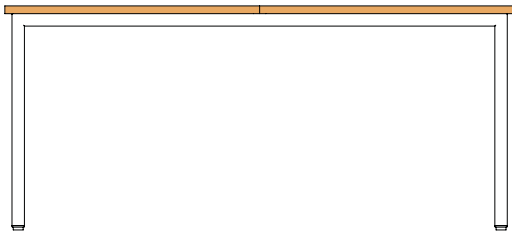

MESA

Mesa can be used with and without GOF screens. All screens sit on desk worksurfaces and fixing brackets are visible. Will require user modifications.

For GOF Desktop Screens see the Screens Section of the Product Guide

MESA PLUS

Mesa Plus screens sit between desk worksurfaces and fixings are discreet, keeping top panels clear. **Mesa Plus cannot be used with GOF screens.**

For Mesa Plus Desktop Screens see the Screens Section of the Product Guide



Mesa Rectangular Double Sided Desking

Mesa and Mesa Plus Footprints (Shown with straight legs)

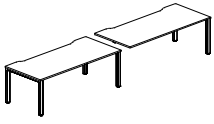

Single Sided

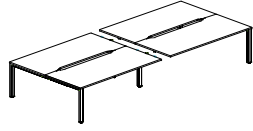

Double Sided

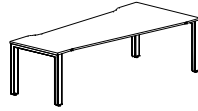

Single Wave
Right-Hand

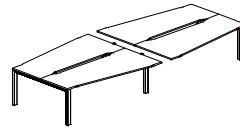

Double Sided
Single Wave

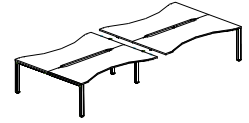

Double Sided
Double Wave

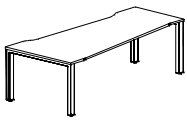

Single Wave
Left-Hand

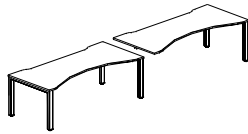

Single Sided
Double Wave



120° Symmetrical
Workstation

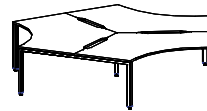

120° 3 User Workstation
Cluster



Mesa Plus Codi Rectangular Double Sided Desking

MESA & MESA PLUS RECTANGULAR DESKING



Desking

Mesa & Mesa Plus are stripped-back Bench desking ranges that combine strength with ease of assembly and use.

Double sided rectangular clusters share end frame components between back to back worksurfaces and when joined side to side.

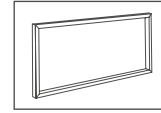

For Mesa Codi add 'C' prefix to product code. i.e. CMEF2012

Mesa Starter Unit Code	Mesa Plus Starter Unit Code	MFC Price	Mesa Add-On Unit Code	Mesa Plus Add-On Unit Code	MFC Price
------------------------	-----------------------------	-----------	-----------------------	----------------------------	-----------

1200mm Deep Double Sided Rectangular Desking

Intermediate End Frames supplied with back to back add-on units.

MEF2012	MPF2012	£702	MEF2012A	MPF2012A	£627
MEF1812	MPF1812	£627	MEF1812A	MPF1812A	£552
MEF1612	MPF1612	£597	MEF1612A	MPF1612A	£522
MEF1412	MPF1412	£552	MEF1412A	MPF1412A	£478
MEF1212	MPF1212	£537	MEF1212A	MPF1212A	£462
MEF1012	MPF1012	£522	MEF1012A	MPF1012A	£448
MEF0812	MPF0812	£508	MEF0812A	MPF0812A	£432

A	B	Optional Cable Basket Code
---	---	----------------------------

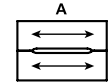

2000	x	1200	MECT20D
1800	x	1200	MECT18D
1600	x	1200	MECT16D
1400	x	1200	MECT14D
1200	x	1200	MECT12D
1000	x	1200	MECT10D
800	x	1200	MECT08D

1600mm Deep Double Sided Rectangular Desking

Intermediate End Frames supplied with back to back add-on units.

MEF2016	MPF2016	£819	MEF2016A	MPF2016A	£673
MEF1816	MPF1816	£746	MEF1816A	MPF1816A	£597
MEF1616	MPF1616	£715	MEF1616A	MPF1616A	£567
MEF1416	MPF1416	£687	MEF1416A	MPF1416A	£537
MEF1216	MPF1216	£656	MEF1216A	MPF1216A	£508
MEF1016	MPF1016	£627	MEF1016A	MPF1016A	£478
MEF0816	MPF0816	£597	MEF0816A	MPF0816A	£448

A	B	Optional Cable Basket Code
---	---	----------------------------

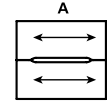

2000	x	1600	MECT20D
1800	x	1600	MECT18D
1600	x	1600	MECT16D
1400	x	1600	MECT14D
1200	x	1600	MECT12D
1000	x	1600	MECT10D
800	x	1600	MECT08D



Mesa Plus Rectangular Double Sided Desking

MESA & MESA PLUS RECTANGULAR DESKING

Mesa & Mesa Plus are stripped-back Bench desking ranges that combine strength with ease of assembly and use.

Single sided rectangular desks share end frame components when joined side to side.

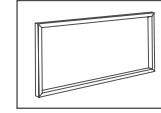

For Mesa Codi add 'C' prefix to product code. i.e. CMEF2006

Mesa Starter Unit Code	Mesa Plus Starter Unit Code	MFC Price	Mesa Add-On Unit Code	Mesa Plus Add-On Unit Code	MFC Price	A	B	Optional Cable Basket Code
------------------------	-----------------------------	-----------	-----------------------	----------------------------	-----------	---	---	----------------------------

600mm Deep Single Sided Rectangular Desking

Intermediate End Frames not available on single sided units.

MEF2006	MPF2006	£448	MEF2006A	MPF2006A	£330	2000	x	600	MECT20
MEF1806	MPF1806	£417	MEF1806A	MPF1806A	£297	1800	x	600	MECT18
MEF1606	MPF1606	£401	MEF1606A	MPF1606A	£284	1600	x	600	MECT16
MEF1406	MPF1406	£388	MEF1406A	MPF1406A	£270	1400	x	600	MECT14
MEF1206	MPF1206	£376	MEF1206A	MPF1206A	£253	1200	x	600	MECT12
MEF1006	MPF1006	£357	MEF1006A	MPF1006A	£240	1000	x	600	MECT10
MEF0806	MPF0806	£343	MEF0806A	MPF0806A	£224	800	x	600	MECT08

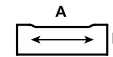

800mm Deep Single Sided Rectangular Desking

Intermediate End Frames not available on single sided units.

MEF2008	MPF2008	£522	MEF2008A	MPF2008A	£388	2000	x	800	MECT20
MEF1808	MPF1808	£478	MEF1808A	MPF1808A	£343	1800	x	800	MECT18
MEF1608	MPF1608	£462	MEF1608A	MPF1608A	£330	1600	x	800	MECT16
MEF1408	MPF1408	£448	MEF1408A	MPF1408A	£314	1400	x	800	MECT14
MEF1208	MPF1208	£432	MEF1208A	MPF1208A	£297	1200	x	800	MECT12
MEF1008	MPF1008	£417	MEF1008A	MPF1008A	£284	1000	x	800	MECT10
MEF0808	MPF0808	£401	MEF0808A	MPF0808A	£270	800	x	800	MECT08

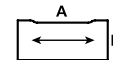

Mesa Plus Codi Rectangular Double Sided Desking

MESA & MESA PLUS WAVE DESKING



Desking

Mesa & Mesa Plus are stripped-back Bench desking ranges that combine strength with ease of assembly and use.

Single Wave desks are designed to position equipment into the deeper corner of the worksurface whilst angling users to improve their focus.

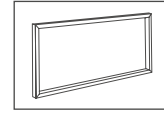

For Mesa Codi add 'C' prefix to product code. i.e. CMEWR2008

Mesa Starter Unit Code	Mesa Plus Starter Unit Code	MFC Price	Mesa Add-On Unit Code	Mesa Plus Add-On Unit Code	MFC Price
------------------------	-----------------------------	-----------	-----------------------	----------------------------	-----------

Right-Hand 800 / 600mm Deep Single Sided Wave Desking

Intermediate End Frames not available on single sided units.

MEWR2008	MPWR2008	£508	N/A	N/A	N/A
MEWR1808	MPWR1808	£478	N/A	N/A	N/A
MEWR1608	MPWR1608	£462	N/A	N/A	N/A
MEWR1408	MPWR1408	£448	N/A	N/A	N/A
MEWR1208	MPWR1208	£432	N/A	N/A	N/A

A	B	C	Optional Cable Basket Code
---	---	---	----------------------------

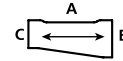

2000	x	800	x	600	MECT20
1800	x	800	x	600	MECT18
1600	x	800	x	600	MECT16
1400	x	800	x	600	MECT14
1200	x	800	x	600	MECT12

Left-Hand 800 / 600mm Deep Single Sided Wave Desking

Intermediate End Frames not available on single sided units.

MEWL2008	MPWL2008	£508	N/A	N/A	N/A
MEWL1808	MPWL1808	£478	N/A	N/A	N/A
MEWL1608	MPWL1608	£462	N/A	N/A	N/A
MEWL1408	MPWL1408	£448	N/A	N/A	N/A
MEWL1208	MPWL1208	£432	N/A	N/A	N/A



2000	x	800	x	600	MECT20
1800	x	800	x	600	MECT18
1600	x	800	x	600	MECT16
1400	x	800	x	600	MECT14
1200	x	800	x	600	MECT12

Suspended Modesty Panel

Fits to rear edge of Mesa & Mesa Plus Single Sided Desks. Please specify board and metalwork finishes.

Code	W	H	Desk Size	MFC Price
BTCPW20	1826 x	250	2000	£102
BTCPW18	1626 x	250	1800	£98
BTCPW16	1426 x	250	1600	£92
BTCPW14	1226 x	250	1400	£86
BTCPW12*	1026 x	250	1200 & 120°	£76
BTCPW10	826 x	250	1000	£73
BTCPW08	626 x	250	800	£68

* Fits to 1200 desk & rear edges of 120° Workstation.



Mesa Plus Double Sided Rectangular Desking

MESA & MESA PLUS WAVE DESKING

Mesa & Mesa Plus are stripped-back Bench desking ranges that combine strength with ease of assembly and use.

Double Wave desks are shaped to sit the user centrally to the desk, with the curved front edge providing an ergonomic user interface.

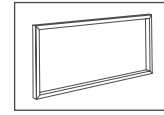

For Mesa Codi add 'C' prefix to product code. i.e. CMEWC2016

A B C Optional Cable Basket Code

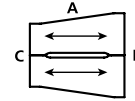

Mesa Starter Unit Code	Mesa Plus Starter Unit Code	MFC Price	Mesa Add-On Unit Code	Mesa Plus Add-On Unit Code	MFC Price
------------------------	-----------------------------	-----------	-----------------------	----------------------------	-----------

800 / 600mm Deep Double Sided Wave Desking

Intermediate End Frames supplied with back to back add-on units.

MEWC2016	MPWC2016	£807	MEWC2016A	MPWC2016A	£733	2000	x	1600	x	1200	MECT20D
MEWC1816	MPWC1816	£746	MEWC1816A	MPWC1816A	£673	1800	x	1600	x	1200	MECT18D
MEWC1616	MPWC1616	£715	MEWC1616A	MPWC1616A	£642	1600	x	1600	x	1200	MECT16D
MEWC1416	MPWC1416	£687	MEWC1416A	MPWC1416A	£612	1400	x	1600	x	1200	MECT14D
MEWC1216	MPWC1216	£656	MEWC1216A	MPWC1216A	£583	1200	x	1600	x	1200	MECT12D

Double Wave Single Sided Desking

Intermediate End Frames not available on single sided units.

MEFDW2008	MPFDW2008	£508	MEFDW2008A	MPFDW2008A	£388	2000	x	600	x	800	MECT20
MEFDW1808	MPFDW1808	£478	MEFDW1808A	MPFDW1808A	£357	1800	x	600	x	800	MECT18
MEFDW1608	MPFDW1608	£462	MEFDW1608A	MPFDW1608A	£343	1600	x	600	x	800	MECT16

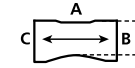

Double Wave Double Sided Desking

Intermediate End Frames supplied with back to back add-on units.

MEFDW2016	MPFDW2016	£807	MEFDW2016A	MPFDW2016A	£733	2000	x	1200	x	1600	MECT20D
MEFDW1816	MPFDW1816	£746	MEFDW1816A	MPFDW1816A	£673	1800	x	1200	x	1600	MECT18D
MEFDW1616	MPFDW1616	£715	MEFDW1616A	MPFDW1616A	£642	1600	x	1200	x	1600	MECT16D

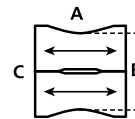

Mesa Plus Double Sided Double Wave Desking

MESA & MESA PLUS 120° DESKING



Desking

Mesa & Mesa Plus are stripped-back Bench desking ranges that combine strength with ease of assembly and use.

120° Workstations are designed for individual use or for use in radial clusters, with the curved front edge providing an ergonomic interface and the shape offering generous work space.

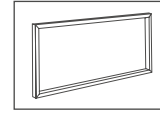

For Mesa Codi add 'C' prefix to product code. i.e. CMESW1208

Mesa Code	Mesa Plus Code	MFC Price	A	B	C	D	Optional Cable Basket Code	
120° Symmetrical Workstation								
MESW1208	MPSW1208	£677	1200	x	800	x	1200	MECT12
MESW1206	MPSW1206	£661	1200	x	600	x	1200	MECT12
120° 3 User Workstation Cluster								
MESWC1208-3	MPSWC1208-3	£1,708	1200	x	800	x	1200	MECT12D
MESWC1206-3	MPSWC1206-3	£1,663	1200	x	600	x	1200	MECT12D

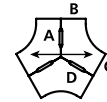
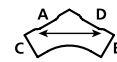

Mesa Plus 120° 3 User Workstation Cluster

MESA & MESA PLUS 120° DESKING

Mesa & Mesa Plus are stripped-back Bench desking ranges that combine strength with ease of assembly and use.

120° Workstations are designed for individual use or for use in radial clusters, with the curved front edge providing an ergonomic interface and the shape offering generous work space.

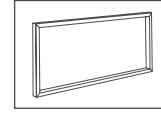

For Mesa Codi add 'C' prefix to product code. i.e. CMESWC1208-6

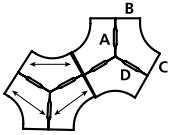
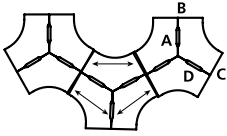
Mesa Code	Mesa Plus Code	MFC Price	A	B	C	D	Optional Cable Basket Code	
<div style="display: flex; justify-content: space-around; align-items: center;">  </div>								
MESWC1208-6	MPSWC1208-6	£3,271	1200	x	800	x	800	MECT12D
MESWC1206-6	MPSWC1206-6	£3,252	1200	x	600	x	600	MECT12D
<div style="display: flex; justify-content: space-around; align-items: center;">  </div>								
MESWC1208-9	MPSWC1208-9	£4,827	1200	x	800	x	800	MECT12D
MESWC1206-9	MPSWC1206-9	£4,812	1200	x	600	x	600	MECT12D



Mesa Plus Codi

D3K MANUAL HEIGHT ADJUSTABLE DESKING

10 Year Guarantee

Desking

- Height range 680 to 930mm.
- Manually adjustable using retractable handle.
- Available in Rectangular, Wave & Consult desk footprints.
- Accepts horizontal cable management.
- For circular cable ports, please substitute "Z" in code for "P".



Maximum Load
Per Top (evenly distributed)



Retractable handle



Code	A	B	C	MFC Price	Code	A	B	C	MFC Price
------	---	---	---	-----------	------	---	---	---	-----------

Rectangular Desk

Can be used with under desk pedestals.

GDSH18Z	1800	x 800		£1,371
GDSH16Z	1600	x 800		£1,272
GDSH14Z	1400	x 800		£1,232
GDSH12Z	1200	x 800		£1,209
GDSH10Z	1000	x 800		£1,190
GDSH08Z	800	x 800		£1,176

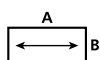

Double Wave Desk

Can be used with under desk pedestals.

GDWHD18Z	1800	x 800	x 1000	£1,471
GDWHD16Z	1600	x 800	x 1000	£1,371

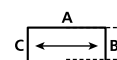

Left Hand Wave Desk

Can be used with under desk pedestals.

GDWHL18Z	1800	x 800	x 1000	£1,471
GDWHL16Z	1600	x 800	x 1000	£1,371
GDWHL14Z	1400	x 800	x 1000	£1,335
GDWHL12Z	1200	x 800	x 1000	£1,308

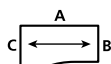

Right Hand Wave Desk

Can be used with under desk pedestals.

GDWHR18Z	1800	x 800	x 1000	£1,471
GDWHR16Z	1600	x 800	x 1000	£1,371
GDWHR14Z	1400	x 800	x 1000	£1,335
GDWHR12Z	1200	x 800	x 1000	£1,308

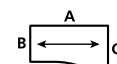

Left Hand Consult Desk

Can be used with under desk pedestals.

GCDHL21Z	2100	x 800	x Ø1000	£1,479
GCDHL19Z	1900	x 800	x Ø1000	£1,424
GCDHL17Z	1700	x 800	x Ø1000	£1,382



Right Hand Consult Desk

Can be used with under desk pedestals.

GCDHR21Z	2100	x 800	x Ø1000	£1,479
GCDHR19Z	1900	x 800	x Ø1000	£1,424
GCDHR17Z	1700	x 800	x Ø1000	£1,382

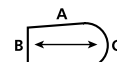

Rectangular Height Adjustable Desk



- A modern executive style fully panel ended desk collection offering stylish looks and traditional standards.
- Available in a variety of desk and workstation footprints.
- Available with 36mm thick MFC or 25mm thick MFC top panels. All have 25mm thick MFC panel ends. Overall heights are 738mm or 727mm.
- Suffix code with relevant letter for required thickness of top panel.

- Delivered and installed fully assembled.
- Extra deep modesty panel available (30mm from floor) (subject to £59 surcharge). Suffix code with - FD.

Code	A	B	C	Group Z 25mm MFC	Group B 36mm MFC
800mm Deep Rectangular Desking					
Can be used with fixed, under desk, tall under desk or desk high pedestals *Cannot accept fixed pedestals.					
KNPD18	1800 x	800		£500	£702
KNPD16	1600 x	800		£432	£636
KNPD14	1400 x	800		£406	£609
KNPD12	1200 x	800		£382	£583
KNPD10	1000 x	800		£365	£569
KNPD08	800 x	800		£362	£566

Code	A	B	C	Group Z 25mm MFC	Group B 36mm MFC
600mm Deep Rectangular Desking					
Can be used with desk high pedestals.					
KNPD186	1800 x	600		£458	£662
KNPD166	1600 x	600		£394	£600
KNPD146	1400 x	600		£365	£569
KNPD126	1200 x	600		£342	£548
KNPD106	1000 x	600		£331	£535
KNPD086	800 x	600		£323	£526

Code	A	B	C	Group Z 25mm MFC	Group B 36mm MFC
Right Hand - Wave Desking					
Can be used with fixed, tall under desk, under desk or desk high pedestals on 800mm side only.					
KNPDWR18	1800 x	800 x	1000	£539	£747
KNPDWR16	1600 x	800 x	1000	£511	£719
KNPDWR14	1400 x	800 x	1000	£478	£687

Code	A	B	C	Group Z 25mm MFC	Group B 36mm MFC
Left Hand - Wave Desking					
Can be used with fixed, tall under desk, under desk or desk high pedestals on 800mm side only.					
KNPDWL18	1800 x	800 x	1000	£539	£747
KNPDWL16	1600 x	800 x	1000	£511	£719
KNPDWL14	1400 x	800 x	1000	£478	£687

Code	A	B	C	Group Z 25mm MFC	Group B 36mm MFC
Kidney Desking					
Can be used with tall under desk or under desk pedestals.					
KNPDK22	2200 x	800		£809	£1,013
KNPDK20	2000 x	800		£782	£983
KNPDK18	1800 x	800		£758	£963
KNPDK16	1600 x	800		£734	£938

Code	A	B	C	Group Z 25mm MFC	Group B 36mm MFC
Bow Fronted Desking					
Can be used with fixed, tall under desk, under desk or desk high pedestals.					
KNPDB20	2000 x	1000 x	800	£658	£860
KNPDB18	1800 x	1000 x	800	£630	£832
KNPDB16	1600 x	1000 x	800	£536	£738



EX10 Universal Workstation

EX10 EXECUTIVE DESKING

10 Year
Guarantee

Desking

- A modern executive style fully panel ended desk collection offering stylish looks and traditional standards.
- Available in a variety of desk and workstation footprints.
- Available with 36mm thick MFC or 25mm thick MFC top panels. All have 25mm thick MFC panel ends. Overall heights are 738mm or 727mm.
- Suffix code with relevant letter for required thickness of top panel.

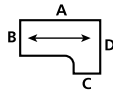
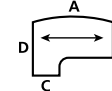
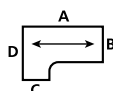
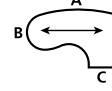
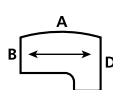
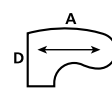

- Delivered and installed fully assembled.
- Extra deep modesty panel available (30mm from floor) (subject to £59 surcharge). Suffix code with - FD.

Code	A	B	C	D	Group Z 25mm MFC	Group B 36mm MFC	Code	A	B	C	D	Group Z 25mm MFC	Group B 36mm MFC						
Right Hand - Universal Workstations Can be used with fixed, tall under desk, under desk or desk high pedestals. 							Left Hand - Bow Fronted Workstation Can be used with fixed, tall under desk, under desk or desk high pedestals. 												
KNPUWS20R	2000	x	800	x	600	x	1200	£691	£893	KNPBWS20L	2000	x	800	x	600	x	1200	£825	£1,027
KNPUWS18R	1800	x	800	x	600	x	1200	£658	£860	KNPBWS18L	1800	x	800	x	600	x	1200	£783	£984
KNPUWS16R	1600	x	800	x	600	x	1200	£620	£825	KNPBWS16L	1600	x	800	x	600	x	1200	£747	£948
KNPUWS14R	1400	x	800	x	600	x	1200	£595	£798										
Left Hand - Universal Workstations Can be used with fixed, tall under desk, under desk or desk high pedestals. 							Right Hand - Consult Fronted Workstations Can be used with tall under desk, under desk or desk high pedestals. 												
KNPUWS20L	2000	x	800	x	600	x	1200	£691	£893	KNPCWS22R	2200	x	800	x	600	x	1200	£942	£1,146
KNPUWS18L	1800	x	800	x	600	x	1200	£658	£860	KNPCWS20R	2000	x	800	x	600	x	1200	£897	£1,100
KNPUWS16L	1600	x	800	x	600	x	1200	£620	£825	KNPCWS18R	1800	x	800	x	600	x	1200	£853	£1,055
KNPUWS14L	1400	x	800	x	600	x	1200	£595	£798										
Right Hand - Bow Fronted Workstation Can be used with fixed, tall under desk, under desk or desk high pedestals. 							Left Hand - Consult Fronted Workstations Can be used with tall under desk, under desk or desk high pedestals. 												
KNPBWS20R	2000	x	800	x	600	x	1200	£825	£1,027	KNPCWS22L	2200	x	800	x	600	x	1200	£942	£1,146
KNPBWS18R	1800	x	800	x	600	x	1200	£783	£984	KNPCWS20L	2000	x	800	x	600	x	1200	£897	£1,100
KNPBWS16R	1600	x	800	x	600	x	1200	£747	£948	KNPCWS18L	1800	x	800	x	600	x	1200	£853	£1,055



EX10 Executive Bow Fronted

- Cut back leg prices are surcharges and are additional to Desk/Workstation price.
- When Workstations/Desks are positioned adjacent to each other, movement between work positions can be improved.
- If cut back legs are utilised the base of the leg is reduced from 800 to 600mm and 600 to 450mm.
- When ordering please specify left or right hand position.

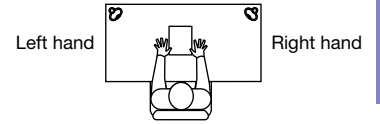

Code	Description	Where Used	Price
EX10 Executive Cut Back Legs			
25mm MFC			
KNCBR8Z	Right Hand	Any 800d Desk or 800 side of Workstation	£114
KNCBL8Z	Left Hand	Any 800d Desk or 800 side of Workstation	£114
KNPCBR6Z	Right Hand	600 side of Workstation	£114
KNPCBL6Z	Left Hand	600 side of Workstation	£114
KNCBR6Z	Right Hand	Any 600d Desk	£114
KNCBL6Z	Left Hand	Any 600d Desk	£114



3 Drawer Desk High Pedestals

When ordering please state handle type. See Storage section.
For 25mm options, please see Storage section.

Base code	W	D	H	36mm MFC Price
Mobile				
KNP3D6M	430	x 600	x 738	£649
KNP3D8M	430	x 800	x 738	£769
Static				
KNP3D6S	430	x 600	x 738	£649
KNP3D8S	430	x 800	x 738	£769



EX10 Executive Left Hand Consult Workstation

RISE SIT/STAND DESKING

5 Year
Motor/
Moving Parts
Guarantee

10 Year
Structural
Guarantee

Deskings

- The Rise family of products, including Rise, Rise Lite and Rise Squared, has been designed to bring true sit/stand capacity to the ever-changing workplace.
- Each model can quickly be adjusted to suit users' height requirements whilst offering both health and lifestyle benefits.
- Available in our most popular footprints and with a selection of control options, Rise offers simple flexibility.

Available Frame Colours

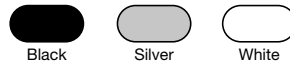

Maximum Load
Per Top (evenly distributed)

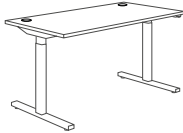

RISE LITE

Rise Lite is a cost-effective version of Rise with no cross bar and a Type A control panel. Rise Lite can be dressed for the occasion with a selection of optional accessories, such as cable trays, spines or modesty panels.

- Rectangular ✔
- Single Wave ✔
- Double Wave (P.O.A.) ✔
- Workstations ✘
- 120 Degree Workstations ✘

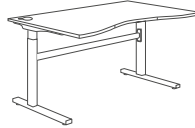

RISE

Rise is a stand-alone desk with a cross bar for enhanced stability. It has cable management and accepts desktop accessories. Cable baskets with cable risers are available to allow for fluid mobility, along with fixed CPU holders.

- Rectangular ✔
- Single Wave ✔
- Double Wave ✔
- Workstations ✔
- 120 Degree Workstations ✔

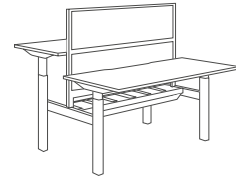

RISE SQUARED

Rise Squared is a premium bank of two desks back to back, integral cable control, split by a two-tier screen. Both desks have a scalloped top for cable egress and accepts desktop accessories.

- Rectangular ✔
- Single Wave (P.O.A.) ✔
- Double Wave (P.O.A.) ✔
- Workstations ✘
- 120 Degree Workstations ✘

How to specify

1. Select Base Code
2. Add Control Panel
3. Order complete desk

Example of code: HDS18A
(Type A control panel)

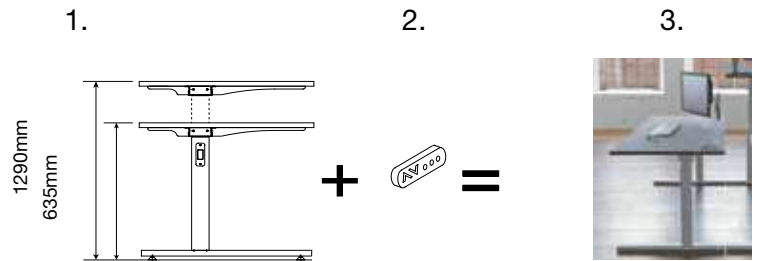

Rise Squared with Endframe Infill Panels



RISE SIT/STAND DESKING

Desking



Type 'A' Control Panel

Ideal for users who only require up & down functions. Panel can be retracted when not in use.



Type 'B' Control Panel

As well as the Up and Down functions, this panel can be programmed with up to three set heights.



Type 'C' Control Panel

As well as the Up and Down functions, this panel can be programmed with up to three set heights, with digital height display.



Type 'E' Control Panel

This angled control has an intuitive tilt function for activation. It has integrated Bluetooth connectivity that is compatible with 'Desk Control' apps and a digital display. It can be programmed with up to four memory positions.



Bluetooth Adapter

Both Rise and Rise Lite can be controlled remotely by using the Bluetooth™ Adaptor and a paired smart device.

HDBA £55



Clear Cable Spine - 1400

Available on the Rise and Rise LT only.

HDCR £144



Rise Lite with GOF Floor Standing Screens

RISE SIT/STAND DESKING



Deskings

Rise Rectangular

From compact forms to larger spans, Rise can be used independently or positioned in clusters, giving both individuals or teams the ability to fine-tune their levels.



Base code	A	B	Optional Cable Basket Code	Type 'A' Price	Type 'B' Price	Type 'C' Price	Type 'E' Price
HDS18	1800	800	MECT18	£1,637	£1,658	£1,733	£1,742
HDS16	1600	800	MECT16	£1,595	£1,615	£1,692	£1,698
HDS14	1400	800	MECT14	£1,555	£1,570	£1,650	£1,656
HDS12	1200	800	MECT12	£1,451	£1,468	£1,548	£1,554
HDS10	1000	800	MECT10	£1,406	£1,424	£1,502	£1,508
HDS08	800	800	MECT08	£1,345	£1,363	£1,442	£1,447

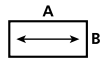

Rise Wave

When space is at a premium but users need to spread out, Wave desks offer the perfect solution combining simple frames with ergonomic work surfaces.

Base code	A	B	C	Optional Cable Basket Code	Type 'A' Price	Type 'B' Price	Type 'C' Price	Type 'E' Price
Right Hand Single Wave Desks								
HDWR18	1800	800	1000	MECT18	£1,675	£1,692	£1,771	£1,776
HDWR16	1600	800	1000	MECT16	£1,633	£1,651	£1,729	£1,733
HDWR14	1400	800	1000	MECT14	£1,588	£1,605	£1,682	£1,690
HDWR12	1200	800	1000	MECT12	£1,555	£1,570	£1,650	£1,656
Left Hand Single Wave Desks								
HDWL18	1800	800	1000	MECT18	£1,675	£1,692	£1,771	£1,776
HDWL16	1600	800	1000	MECT16	£1,633	£1,651	£1,729	£1,733
HDWL14	1400	800	1000	MECT14	£1,588	£1,605	£1,682	£1,690
HDWL12	1200	800	1000	MECT12	£1,555	£1,570	£1,650	£1,656

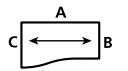
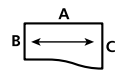

Double Wave Desks

HDWD18	1800	800	1000	MECT18	£1,675	£1,692	£1,771	£1,776
HDWD16	1600	800	1000	MECT16	£1,633	£1,651	£1,729	£1,733

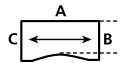

Rise Right Hand Workstation



Rise Workstation

Whether having lots of equipment or paper, Rise workstations deliver.

Base code	A	B	C	D	Optional Cable Basket Code	Type 'A' Price	Type 'B' Price	Type 'C' Price	Type 'E' Price
HUWSR18	1800	x 800	x 600	x 1200	MECT18	£2,504	£2,520	£2,599	£2,605
HUWSR16	1600	x 800	x 600	x 1200	MECT16	£2,457	£2,474	£2,554	£2,558
HUWSR14	1400	x 800	x 600	x 1200	MECT14	£2,414	£2,430	£2,510	£2,514
HUWSL18	1800	x 800	x 600	x 1200	MECT18	£2,504	£2,520	£2,599	£2,605
HUWSL16	1600	x 800	x 600	x 1200	MECT16	£2,457	£2,474	£2,554	£2,558
HUWSL14	1400	x 800	x 600	x 1200	MECT14	£2,414	£2,430	£2,510	£2,514

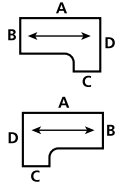

Rise 120° Workstation

Having to accommodate multiple users or intensive work patterns, sitting or standing, Rise helps position your equipment just where it is needed.

Base code	A	B	C	D	Optional Cable Basket Code	Type 'A' Price	Type 'B' Price	Type 'C' Price	Type 'E' Price
HDY128	1200	x 800	x 800	x 1200	MECT12	£2,476	£2,494	£2,572	£2,578
HDY126	1200	x 600	x 600	x 1200	MECT12	£2,429	£2,449	£2,525	£2,488
HDY106	1000	x 600	x 600	x 1000	MECT10	£2,408	£2,424	£2,503	£2,508

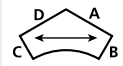

Modesty Panels

Code	Panel Length	Desk	Price
BTCPW18	1626 x 250	1800	£98
BTCPW16	1426 x 250	1600	£92
BTCPW14	1226 x 250	1400	£86
BTCPW12	1026 x 250	1200	£76



Rise 120 Degree Workstation

RISE LITE SIT/STAND DESKING



Desking

Rise Lite Rectangular

Needing a desk or a table, Rise Lite keeps it simple. Fluid and versatile; allowing users to take control of their environment.

- Delivered and installed fully assembled
- A cost effective version of Rise Sit/Stand Desking
- Available with Type A control panel
- No cross bar

How to specify

1. Select Product / Code with plain top
2. If Ports are required, suffix code with P
3. If Scallop required, suffix code with S

Example: HDLS14S - 1400
Rectangular Desk with scallop top

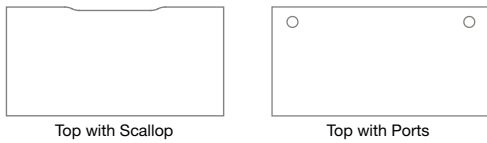

Available Frame Colours

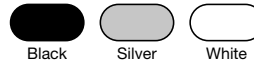

Maximum Load
Per Top (evenly distributed)

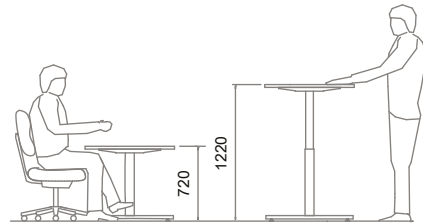

Sit/Stand worksurface range from 720mm to 1220mm

Code	A	B	Optional Cable Basket Code
HDLS18	1800	800	MECT18
HDLS16	1600	800	MECT16
HDLS14	1400	800	MECT14
HDLS12	1200	800	MECT12

Plain Top	P (Ports)	S (Scallop)
£1,377	£1,416	£1,416
£1,366	£1,403	£1,403
£1,355	£1,391	£1,391
£1,341	£1,380	£1,380

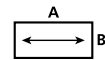

Rise Light with GOF Floor Standing Screens



RISE LITE SIT/STAND DESKING

Desking

Rise LiteSingle Wave

Rise Lite can be specified to be cost-effective or dressed for the occasion with a selection of optional accessories, such as cable trays, spines or modesty panels. Rise reaches the grade.

- Delivered and installed fully assembled
- A cost effective version of Rise Sit/Stand Desking
- Available with Type A control panel
- No cross bar

Code	A	B	C	Optional Cable Basket Code	Plain Top	P (Ports)	S (Scallop)
					£1,446 £1,433 £1,421	£1,484 £1,470 £1,457	£1,484 £1,470 £1,457
Right hand							
HDLWR18	1800	800	1000	MECT18	£1,446	£1,484	£1,484
HDLWR16	1600	800	1000	MECT16	£1,433	£1,470	£1,470
HDLWR14	1400	800	1000	MECT14	£1,421	£1,457	£1,457
Left hand							
HDLWL18	1800	800	1000	MECT18	£1,446	£1,484	£1,484
HDLWL16	1600	800	1000	MECT16	£1,433	£1,470	£1,470
HDLWL14	1400	800	1000	MECT14	£1,421	£1,457	£1,457

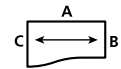
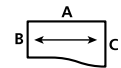

Modesty Panels

Code	Panel Length	Desk	Price
BTCPW18	1626 x 250	1800	£98
BTCPW16	1426 x 250	1600	£92
BTCPW14	1226 x 250	1400	£86
BTCPW12	1026 x 250	1200	£76



Wave Desks shown back to back with Modesty Panels

RISE SQUARED SIT/STAND DESKING

5 Year
Motor/
Moving Parts
Guarantee

10 Year
Structural
Guarantee

Deskimg

- Scalloped Top for cable egress
- Accepts desk top accessories
- Supplied with integral cable control
- Selection of control panels
- Shared back to back components

Available Frame Colours

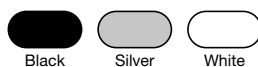

Maximum Load
Per Top (evenly distributed)



How to specify

1. Select a base code
2. Add control panels
3. Order complete desk

Example: **HBS1616B** (type B control panel)

Note: Screens ordered separately.

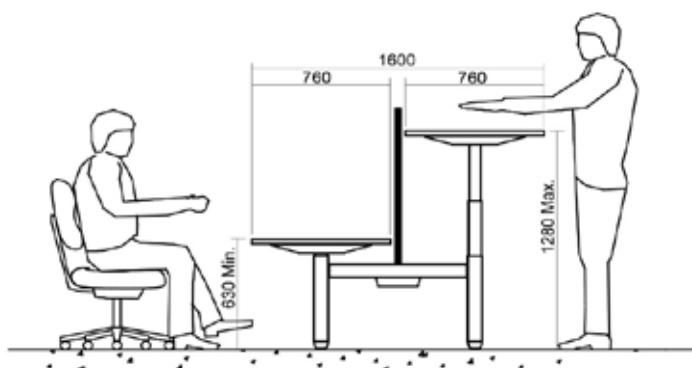

Desks - with scalloped tops

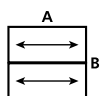

Code	A	B	2 x Optional Cable Tray	Type 'A' Price	Type 'B' Price	Type 'C' Price	Type 'E' Price
HBS2016	2000	1600	MECT20	£3,293	£3,332	£3,478	£3,499
HBS1816	1800	1600	MECT18	£3,231	£3,267	£3,413	£3,435
HBS1616	1600	1600	MECT16	£3,169	£3,205	£3,350	£3,370
HBS1416	1400	1600	MECT14	£3,106	£3,140	£3,287	£3,307
HBS1216	1200	1600	MECT12	£3,040	£3,077	£3,223	£3,245

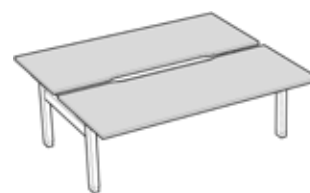

Rise Squared with Separator Screen and Endframe Infill Panel



RISE SQUARED SIT/STAND DESKING

Desking

Desk to Desk Chain

Cable control to fit between desks

Code

HBSDDC

Price

£102

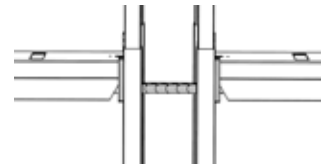

Endframe Infill Panel

fits between legs and can be used as cable riser

Code

HBSEP

Price

£393

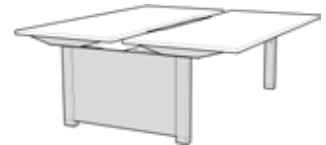

Screens

Code W H

Band 1 Price	Band 2 Price	Band 3 Price
--------------	--------------	--------------

Fabric

VSFG2014	2000	1400
VSFG1814	1800	1400
VSFG1614	1600	1400
VSFG1414	1400	1400
VSFG1214	1200	1400

£433	£461	£522
£393	£419	£474
£356	£377	£433
£337	£356	£395
£312	£335	£373



Fabric Separator Screen (positions screen apart)

VSFS0214	200	1400
----------	-----	------

£226	£250	£273
------	------	------



Part Glazed - Fabric / Acrylic (frosted or clear)

VSAG2014	2000	1400
VSAG1814	1800	1400
VSAG1614	1600	1400
VSAG1414	1400	1400
VSAG1214	1200	1400

£694	£735	£836
£631	£670	£760
£569	£606	£693
£538	£569	£636
£502	£537	£601

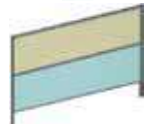

Acrylic Separator Screen (positions screen apart)

VSAS0214	200	1400
----------	-----	------

£228	£279	£302
------	------	------



Rise Squared with Separator Screen and HBSEP Endframe Infill Panel

DESKIT DESKING



Desking

How to specify:

1. Select range endframe code
2. Add product model base code
3. Order complete desk



Example: EPD188 - 1800 x 800 EX10 Rectangular Desk
or KND188 - 1800 x 800 X10 Rectangular Desk.



Base Code	A	B	C	Optional Cable Basket	BK	GK	EP	KN	KV	KP	
800mm Deep Rectangular											
D188	1800	800		MECT18	£449	£474	£491	£491	£449	£449	
D168	1600	800		MECT16	£388	£408	£424	£424	£388	£388	
D148	1400	800		MECT14	£361	£386	£396	£396	£361	£361	
D128	1200	800		MECT12	£340	£364	£372	£372	£340	£340	
D108	1000	800		MECT10	£328	£356	£360	£360	£328	£328	
D088	800	800		MECT08	£319	£345	£355	£355	£319	£319	
600mm Deep Rectangular											
D186	1800	600		MECT18	£403	£442	£449	£449	£403	£403	
D166	1600	600		MECT16	£351	£369	£388	£388	£351	£351	
D146	1400	600		MECT14	£326	£341	£360	£360	£326	£326	
D126	1200	600		MECT12	£306	£331	£337	£337	£306	£306	
D106	1000	600		MECT10	£300	£319	£326	£326	£300	£300	
D086	800	600		MECT08	£285	£306	£316	£316	£285	£285	
Right Hand Wave											
RW188	1800	800	1000	MECT18	£483	£539	£532	£532	£483	£483	
RW168	1600	800	1000	MECT16	£457	£474	£504	£504	£457	£457	
RW148	1400	800	1000	MECT14	£427	£449	£471	£471	£427	£427	
RW128	1200	800	1000	MECT12	£413	£429	£453	£453	£413	£413	
RW108	1000	800	1000	MECT10	£402	£417	£442	£442	£402	£402	

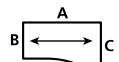
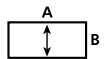
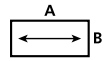

Rectangular Bench Deskit

Base Code	A	B	C	D	Optional Cable Basket	BK	GK	EP	KN	KV	KP	
Left Hand Wave												
LW188	1800	800	1000		MECT18	£483	£539	£532	£532	£483	£483	
LW168	1600	800	1000		MECT16	£457	£474	£504	£504	£457	£457	
LW148	1400	800	1000		MECT14	£427	£449	£471	£471	£427	£427	
LW128	1200	800	1000		MECT12	£413	£429	£453	£453	£413	£413	
LW108	1000	800	1000		MECT10	£402	£417	£442	£442	£402	£402	
Double Wave												
DW188	1800	800	1000		MECT18	£483	£539	£532	£532	£483	£483	
DW168	1600	800	1000		MECT16	£457	£474	£504	£504	£457	£457	
Right Hand D-End												
DDR20	2000	800			MECT16	£545	£565	£584	£584	£545	£545	
DDR18	1800	800			MECT14	£492	£510	£530	£530	£492	£492	
DDR16	1600	800			MECT12	£427	£454	£457	£457	£427	£427	
Left Hand D-End												
DDL20	2000	800			MECT16	£545	£565	£584	£584	£545	£545	
DDL18	1800	800			MECT14	£492	£510	£530	£530	£492	£492	
DDL16	1600	800			MECT12	£427	£454	£457	£457	£427	£427	
Kidney												
KD22	2200	800			MECT14	£754	£775	£795	£795	£754	£754	
KD20	2000	800			MECT12	£727	£748	£765	£765	£727	£727	
KD18	1800	800			MECT10	£707	£729	£743	£743	£707	£707	
KD16	1600	800			MECT08	£675	£692	£722	£722	£675	£675	
Bow Fronted												
BD20	2000	800	1000		MECT20	£603	£624	£642	£642	£603	£603	
BD18	1800	800	1000		MECT18	£577	£601	£616	£616	£577	£577	
BD16	1600	800	1000		MECT16	£486	£506	£529	£529	£486	£486	
120° Workstation												
YD128	1200	800	800	1200	MECT12	£683	£706	£747	£747	£683	£683	
YD126	1200	600	600	1200	MECT12	£660	£683	£723	£723	£660	£660	
YD108	1000	800	800	1000	MECT10	£613	£636	£676	£676	£613	£613	
YD106	1000	600	600	1000	MECT10	£613	£636	£676	£676	£613	£613	



D3K Deskit Left Hand and Right Hand Wave

DESKIT DESKING



Desking

How to specify:

1. Select range endframe code
2. Add product model base code
3. Order complete desk



Example: EPD188 - 1800 x 800 EX10 Rectangular Desk
or KND188 - 1800 x 800 X10 Rectangular Desk.

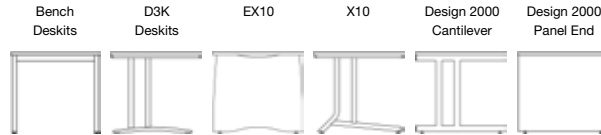

Base Code	A	B	C	D	Optional Cable Basket	BK	GK	EP	KN	KV	KP
RH Workstation - 800mm Return											
UWR188	1800	800	800	1200	MECT16	£638	£671	£699	£699	£638	£638
UWR168	1600	800	800	1200	MECT14	£600	£638	£661	£661	£600	£600
LH Workstation - 800mm Return											
UWL188	1800	800	800	1200	MECT16	£638	£671	£699	£699	£638	£638
UWL168	1600	800	800	1200	MECT14	£600	£638	£661	£661	£600	£600
RH Workstation - 600mm Return											
UWR206	2000	800	600	1200	MECT18	£613	£648	£676	£676	£613	£613
UWR186	1800	800	600	1200	MECT16	£582	£615	£642	£642	£582	£582
UWR166	1600	800	600	1200	MECT14	£554	£586	£609	£609	£554	£554
UWR146	1400	800	600	1200	MECT12	£533	£564	£584	£584	£533	£533
LH Workstation - 600mm Return											
UWL206	2000	800	600	1200	MECT18	£613	£648	£676	£676	£613	£613
UWL186	1800	800	600	1200	MECT16	£582	£615	£642	£642	£582	£582
UWL166	1600	800	600	1200	MECT14	£554	£586	£609	£609	£554	£554
UWL146	1400	800	600	1200	MECT12	£533	£564	£584	£584	£533	£533

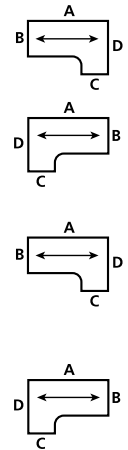

Design 2000 Cantilever Deskit

10 Year Guarantee

DESKIT DESKING

Desking

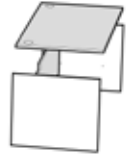

Base Code A B C D Optional Cable Basket BK GK EP KN KV KP

RH Bow Fronted Workstation - 600mm Return

UWBR206	2000	800	600	1200	MECT18	£710	£747	£774	£774	£710	£710
UWBR186	1800	800	600	1200	MECT16	£692	£713	£739	£739	£692	£692
UWBR166	1600	800	600	1200	MECT14	£652	£683	£706	£706	£652	£652

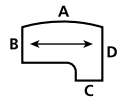

LH Bow Fronted Workstation - 600mm Return

UWBL206	2000	800	600	1200	MECT18	£710	£747	£774	£774	£710	£710
UWBL186	1800	800	600	1200	MECT16	£692	£713	£739	£739	£692	£692
UWBL166	1600	800	600	1200	MECT14	£652	£683	£706	£706	£652	£652

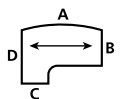

RH Consult Workstation - 600mm Return

UWCR226	2200	800	600	1200	MECT16	£895	£928	£952	£952	£895	£895
UWCR206	2000	800	600	1200	MECT14	£861	£896	£920	£920	£861	£861
UWCR186	1800	800	600	1200	MECT12	£836	£865	£885	£885	£836	£836
UWCR166	1600	800	600	1200	MECT10	£810	£841	£860	£860	£810	£810

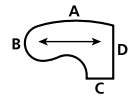

LH Consult Workstation - 600mm Return

UWCL226	2200	800	600	1200	MECT16	£895	£928	£952	£952	£895	£895
UWCL206	2000	800	600	1200	MECT14	£861	£896	£920	£920	£861	£861
UWCL186	1800	800	600	1200	MECT12	£836	£865	£885	£885	£836	£836
UWCL166	1600	800	600	1200	MECT10	£810	£841	£860	£860	£810	£810

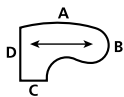

Symmetrical Workstation

UW188S	1800	800	800	1800	MECT16	£733	£776	£813	£813	£733	£733
UW168S	1600	800	800	1600	MECT14	£700	£738	£769	£769	£700	£700
UW148S	1400	800	800	1400	MECT12	£671	£710	£736	£736	£671	£671
UW128S	1200	800	800	1200	MECT10	£640	£677	£709	£709	£640	£640
UW126S	1200	600	600	1200	MECT10	£640	£677	£709	£709	£640	£640

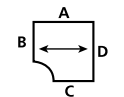

X10 Deskit Right Hand and Left Hand Wave

DESKIT ADD-ONS

DESKING

10 Year Guarantee

Desking

- Extra deep modesty panel available (57mm from floor) (subject to £59 surcharge). Suffix code with -FD.
- Not available on X10 Desks / Workstations

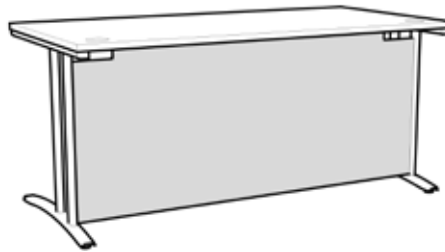

Desk shown with D3K endframes & full depth modesty panel. Example: GKD168FD

Cut Back Endframes

Cut back endframes for 800d desks can be used to help create additional leg space when desks or workstations are used together. Cantilever frames are best for this. They are offered in Left or Right hand options and are supplied with all necessary fittings and desk to desk link brackets. It is recommended that full end frames are used at the end of runs.



Base Code	Description
CBL8	800mm Left hand
CBR8	800mm Right Hand

	Bench Desks	D3K Desks	EX10	X10	Design 2000 Cantilever	Design 2000 Panel End
	BK	GK	EP	KN	KV	KP
	£110	£110	£110	£110	£110	£110
	£110	£110	£110	£110	£110	£110

Return Units

Supplied with a single endframe and fixing kit (desk not supplied).

Base Code	A	B
-----------	---	---

	Bench Desks	D3K Desks	EX10	X10	Design 2000 Cantilever	Design 2000 Panel End
	BK	GK	EP	KN	KV	KP
	£242	£257	£260	£260	£242	£242
	£227	£246	£254	£254	£227	£227

RD106	1000	600
RD086	800	600

MECT10*	£242	£257	£260	£260	£242	£242
MECT08*	£227	£246	£254	£254	£227	£227

*For extended to rear of desk, use

MECT16 or MECT14 - depending upon length of return.

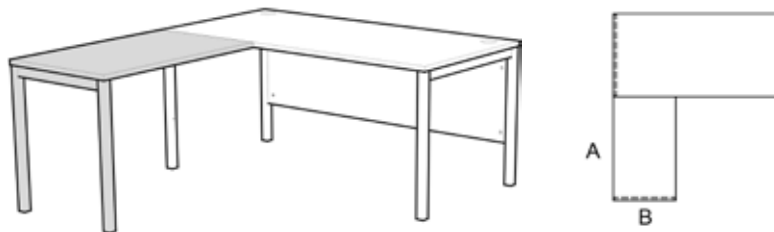

Conference End Tables

Supplied with pillar legs & fixing brackets for all styles of frames.

Code	A	B	Price
SET16	1600	600	£699
SET12	1200	450	£661
FCE12	800	Ø1200	£699
FTE12	800	Ø1200	£699

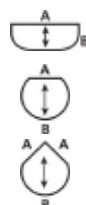

DESKIT OVER DESK STORAGE DESKING

Over Desk Storage

Fits to all **Deskit** standard desk models and can be retro fitted.
For other desk compatibility, please contact our Sales Department.

Code	W	D	H	Price
FH16	1600	320	375	£242
FH14	1400	320	375	£218
FH12	1200	320	375	£203
FH10	1000	320	375	£187
FH08	800	320	375	£170
FH06	600	320	375	£164

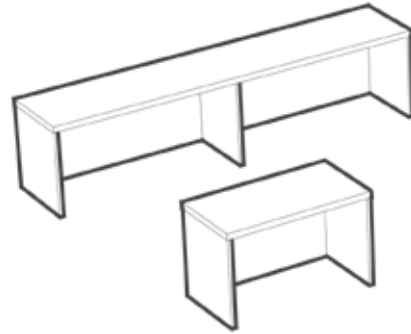

Example of use.

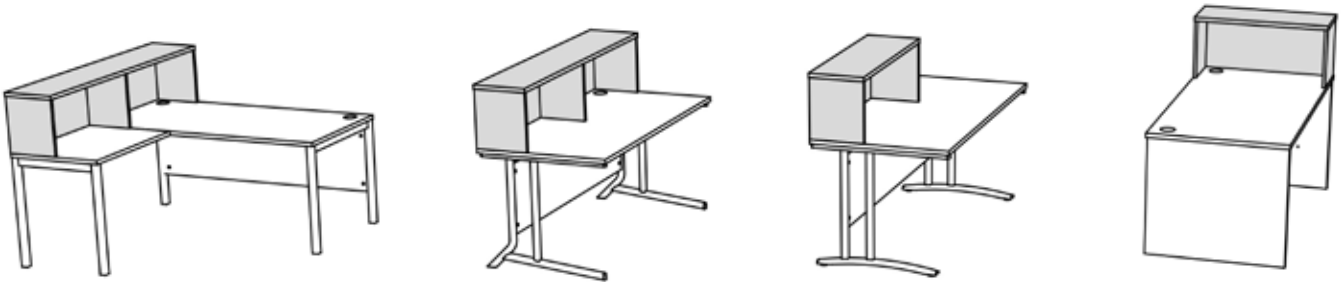

Design 2000 Deskit Rectangular Desk shown with optional Overdesk Storage

HOME WORKER DESKING

2 Year
Guarantee

Deskimg

With its hairpin leg design and integrated shelf space, this desk can be a nice addition to any home. With the shelf space offering an area to store those laptop and additional paperwork away to help keep your home feeling like a home when you have finished for the day.

Features

- Choice of MFC Top finishes.
- Hair pin legs.
- Metal to metal fixings.
- Integrated shelf space (100mm).
- One person easy to assemble.

Code	W	D	H	Unit Price
Rectangular Desk				
HWK106Z	1000	x 600	x 800	£338
HWK126Z	1200	x 600	x 800	£350
HWK146Z	1400	x 600	x 800	£363



2 Year
Guarantee

HOME WORKER DESKING

Introducing into the Homeworke range is our new fold away desk. With space at a premium in some homes, this desk offers a neat alternative to the static desk. Once folded, the desk can be stored away to free up space. With its tool free assembly, the desk will fold and unfold instantly making it a simple but effective solution.

Features

- Choice of MFC Top finishes
- Choice of frame colours
- Metal to metal fixings
- Folding desk for ease of storage
- One person tool free assembly
- Upper shelf

Code	W	D	H	Unit Price
Rectangular Desk				
EXHW12	1200	x 600	x 727/1200	£338
EXHW10	1000	x 600	x 727/1200	£350



D3K FULLY WELDED DESKING

25 Year
Structural
Guarantee

Desking

- Fully Welded with stylish end frame that can accept cable management.
- Available with optional end frame covers.
- Available in a variety of desk and workstation footprints.
- Overall height 727mm with 25mm MFC tops.

Surcharge for Pastel Paint – £32 per item

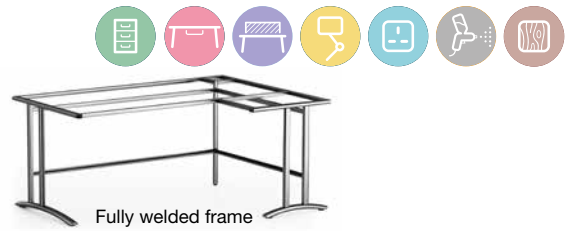

Code	A	B	C	Price
800mm Deep Rectangular Desking Can be used with tall under desk, under desk or desk high pedestals				
GDS18Z	1800	x	800	£583
GDS16Z	1600	x	800	£500
GDS14Z	1400	x	800	£471
GDS12Z	1200	x	800	£450
GDS10Z*	1000	x	800	£435
GDS08Z*	800	x	800	£422

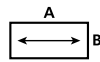

Code	A	B	C	Price
600mm Deep Rectangular Desking Can be used with desk high pedestals.				
GDS186Z	1800	x	600	£533
GDS166Z	1600	x	600	£457
GDS146Z	1400	x	600	£431
GDS126Z	1200	x	600	£402
GDS106Z	1000	x	600	£394
GDS086Z	800	x	600	£374

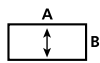

Code	A	B	C	D	Price	
Right Hand Wave Desking Can be used with tall under desk, under desk or desk high pedestals on 800mm side only.						
GDWR18Z	1800	x	800	x	1000	£661
GDWR16Z	1600	x	800	x	1000	£583
GDWR14Z	1400	x	800	x	1000	£550
GDWR12Z	1200	x	800	x	1000	£529

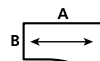

Code	A	B	C	D	Price	
Left Hand Wave Desking Can be used with tall under desk, under desk or desk high pedestals on 800mm side only.						
GDWL18Z	1800	x	800	x	1000	£661
GDWL16Z	1600	x	800	x	1000	£583
GDWL14Z	1400	x	800	x	1000	£550
GDWL12Z	1200	x	800	x	1000	£529

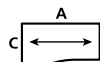

Code	A	B	C	Price		
Right Hand Consult Desking Can be used with tall under desk, under desk or desk high pedestals on 800mm side only.						
GCDR21Z	2100	x	800	x	ø1000	£672
GCDR19Z	1900	x	800	x	ø1000	£623
GCDR17Z	1700	x	800	x	ø1000	£590

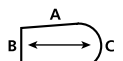

Code	A	B	C	Price		
Left Hand Consult Desking Can be used with tall under desk, under desk or desk high pedestals on 800mm side only.						
GCDL21Z	2100	x	800	x	ø1000	£672
GCDL19Z	1900	x	800	x	ø1000	£623
GCDL17Z	1700	x	800	x	ø1000	£590

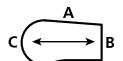

Code	A	B	C	Price		
Double Wave Desking Can be used with under desk or tall under desk pedestals.						
GDWD18Z	1800	x	800	x	1000	£661
GDWD16Z	1600	x	800	x	1000	£583

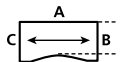

Code	A	B	C	Price
Conference End Tables				
Circular				
GCCE12Z	800	x	ø1200	£625
Tear Drop				
GCTE12Z	800	x	ø1200	£705
Semi-Circular				
GSCT16Z	800	x	ø1600	£674
GSCT12Z	600	x	ø1200	£625

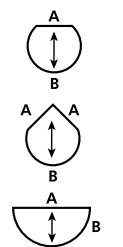

Code	W	D	H	Price		
Accessories						
Mobile Lectern & Trolley.						
GLZ	690	x	720	x	1170	£897
Angled work surface. (Top size 590w x 560d)						
GPCSZ	590	x	800	x	1000	£1,049
CPU holder and rear monitor shield included.						
GDDL				£13		
Desk to Desk Link Bracket						



GLZ



GPCSZ



Code A B C D Price

Right Hand Universal Workstations
Can be used with under desk,
tall under desk or desk high pedestals.

GUWSR18Z	1800	x	800	x	600	x	1200	£840
GUWSR16Z	1600	x	800	x	600	x	1200	£808
GUWSR14Z	1400	x	800	x	600	x	1200	£776

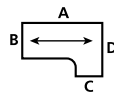

Code A B C D Price

Right Hand Consult Workstations
Can be used with under desk,
tall under desk or desk high pedestals.

GCWSR22Z	2200	x	800	x	600	x	1200	£1,048
GCWSR20Z	2000	x	800	x	600	x	1200	£996
GCWSR18Z	1800	x	800	x	600	x	1200	£948

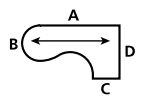

Left Hand Universal Workstations
Can be used with under desk,
tall under desk or desk high pedestals.

GUWSL18Z	1800	x	800	x	600	x	1200	£840
GUWSL16Z	1600	x	800	x	600	x	1200	£808
GUWSL14Z	1400	x	800	x	600	x	1200	£776

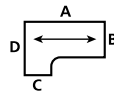

Left Hand Consult Workstations
Can be used with under desk,
tall under desk or desk high pedestals.

GCWSL22Z	2200	x	800	x	600	x	1200	£1,048
GCWSL20Z	2000	x	800	x	600	x	1200	£996
GCWSL18Z	1800	x	800	x	600	x	1200	£948

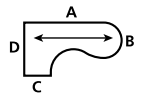

Symmetrical Workstations
Can be used with under desk,
tall under desk or desk high pedestals.
*Except 600 x 600mm

GUWSR18Z	1600	x	800	x	600	x	1200	£874
GUWSR16Z	1400	x	800	x	600	x	1200	£821
GUWSR14Z	1200	x	800	x	600	x	1200	£679
GWS126SZ*	1200	x	800	x	600	x	1200	£679

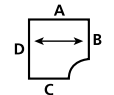

120° Workstations
Can be used with under desk,
tall under desk or desk high pedestals.
*Except 600 x 600mm

GDY128Z	1200	x	800	x	800	x	1200	£750
GDY126Z*	1200	x	600	x	600	x	1200	£750
GDY106Z*	1000	x	600	x	600	x	1200	£707

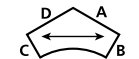

GOF Desk Top Screen Bracket Information
Please refer to our Screens & Pods Section for GOF
desk top screens.

* Requires link post

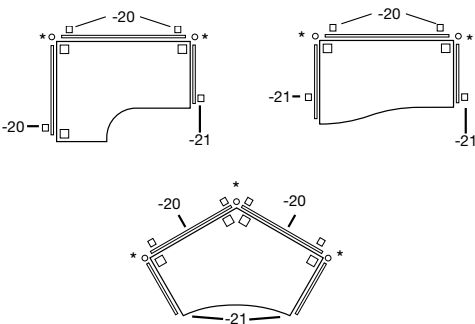

DESIGN 2000 FULLY WELDED DESKING



Desking

- Our most sustainable Desk for over 40 years.
- Extensive range including Rectangular Desks, Workstations and Wave Desks.
- Continuous welded underframe for heavy duty environments.
- Available with optional cable management and end frame covers.
- Overall height 727mm with 25mm MFC tops.



Surcharge for Pastel Paint – £32 per item

Code	A	B	C	Price
------	---	---	---	-------

800mm Deep Rectangular Desking

Can be used with tall under desk, under desk or desk high pedestals.

VD728Z	1800 x 800			£534
VD638Z	1600 x 800			£459
VD568Z	1400 x 800			£433
VD488Z	1200 x 800			£413
VD408Z*	1000 x 800			£401
VD318Z*	800 x 800			£389



600mm Deep Rectangular Desking

Can be used with desk high pedestals.

VD726Z	1800 x 600			£483
VD636Z	1600 x 600			£419
VD566Z	1400 x 600			£394
VD486Z	1200 x 600			£372
VD406Z	1000 x 600			£368
VD316Z	800 x 600			£352



Right Hand Wave Desking

Can be used with tall under desk, under desk or desk high pedestals on 800mm side only.

8DWR18Z	1800 x 800 x 1000			£607
8DWR16Z	1600 x 800 x 1000			£534
8DWR14Z	1400 x 800 x 1000			£506
8DWR12Z	1200 x 800 x 1000			£487



Left Hand Wave Desking

Can be used with tall under desk, under desk or desk high pedestals on 800mm side only.

8DWL18Z	1800 x 800 x 1000			£607
8DWL16Z	1600 x 800 x 1000			£534
8DWL14Z	1400 x 800 x 1000			£506
8DWL12Z	1200 x 800 x 1000			£487



GOF Desk Top Screen Bracket Information

Please refer to our Screens & Pods Section for GOF desk top screens (Not available on Wire Managed Desks).

* Requires link post

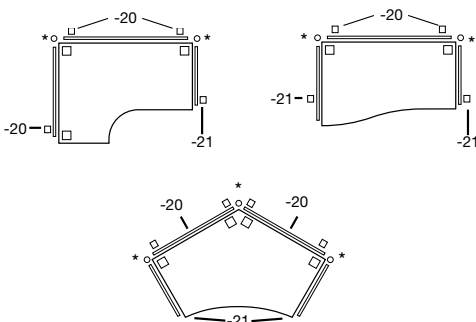

Code	A	B	C	Price
------	---	---	---	-------

Right Hand D-End Desking

Can be used with tall under desk, under desk or desk high pedestals.

VD798RDZ	2000 x 800			£636
VD728RDZ	1800 x 800			£578
VD638RDZ	1600 x 800			£503



Left Hand D-End Desking

Can be used with tall under desk, under desk or desk high pedestals.

VD798LDZ	2000 x 800			£636
VD728LDZ	1800 x 800			£578
VD638LDZ	1600 x 800			£503



Double Wave Desking

Can be used with under desk or tall under desk pedestals.

8DWD18Z	1800 x 800 x 1000			£595
8DWD16Z	1600 x 800 x 1000			£523

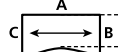

Code	A	B	C	D	Price
------	---	---	---	---	-------

Right Hand Universal Workstations

Can be used with under desk, tall under desk or desk high pedestals.

UWS18RZ	1800 x 800 x 600 x 1200				£831
UWS16RZ	1600 x 800 x 600 x 1200				£786
UWS14RZ	1400 x 800 x 600 x 1200				£753
UWS188RZ	1800 x 800 x 800 x 1200				£897
UWS168RZ	1600 x 800 x 800 x 1200				£849

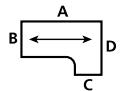

Left Hand Universal Workstations

Can be used with under desk, tall under desk or desk high pedestals.

UWS18LZ	1800 x 800 x 600 x 1200				£831
UWS16LZ	1600 x 800 x 600 x 1200				£786
UWS14LZ	1400 x 800 x 600 x 1200				£753
UWS188LZ	1800 x 800 x 800 x 1200				£897
UWS168LZ	1600 x 800 x 800 x 1200				£849

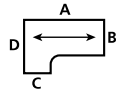

Symmetrical Workstations

Can be used with under desk, tall under desk or desk high pedestals. *Except 600 x 600mm

UWS16SZ	1600 x 800 x 800 x 1600				£853
UWS14SZ	1400 x 800 x 800 x 1400				£800
UWS12SZ	1200 x 800 x 800 x 1200				£690
UWS126SZ*	1200 x 600 x 600 x 1200				£690

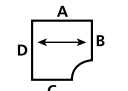

Design 2000 Cantilever Cut Back Legs

8CBR	Right Hand	Any 800d Desk or 800 side of Workstation	£110
8CBL	Left Hand	Any 800d Desk or 800 side of Workstation	£110

25 Year
Structural
Guarantee

DESIGN 2000 FULLY WELDED DESKING

Desking



MODULAR RECEPTION UNITS DESKING

10 Year
Guarantee

Desking



Our comprehensive range of modular units provides you with almost unlimited configurations to create the footprint for any reception environment.

- Multiple choice of units
- DDA compliant base units
- Vast range of board finishes
- Compatible to our wide range of furniture
- Glass shelf options

Please contact Sales for more information...
We can aid your planning and provide a suitable proposal and quotation.

Now available in all standard MFC finishes.

How to Order Units

Leg Positions

Base units are available with either full or cutback panel ends. Full panels are always required on the outside edge.

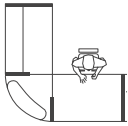

Cut back panels specified at joint. Full panels are required on the outside edge.



Full panels are required when joining to DDA units.

Cable ports - suffix code (-p)

Units are priced without cable ports.
If required, suffix code with (-P) and state cable ports required.
Cost addition of £92 Retail per unit.



Footprints Explanation

Straight or curved options are available to accommodate space planning requirements.

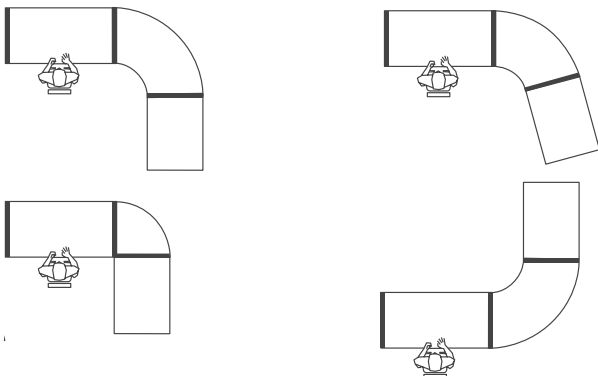

Important Information

Reception units are made to order and the lead-time to supply these goods will reflect this. Special products are not available.

Modular Panel End Units Containing:

interchangeable base, top & counter units. Base units can be specified with cut back panels providing clear legroom when adjacent modules are linked. This flexible collection can cater for a variety of front-office requirements whilst offering a robust structure and cost effective solution.

All Modules Have:

25mm tops and end panels finished with high impact resistant edging.

Key Features:

- Ease of identifying, specifying & ordering modules.
- Ease of installation - either tool-free or with use of standard Allen key.
- Base units supplied with steel kick plates.
- Optional cable management.
- Optional third level accessories.
- Base units are 750 tall to allow 700 clearance for DDA compliance.
- Base units supplied with shelf unless stated.

PLEASE NOTE:

UNDER DESK PEDESTALS WILL PROTRUDE BY APPROX 100MM.

Design and Manufacture

Designed and Manufactured to conform to

BS EN 527-1:2000
Office furniture, work tables and desk dimensions.

BS EN 527-2:2002
Test methods for the determination of stability.

BS EN 527-3:2003
Test methods for the determination of strength.

BS 3044:1990
Ergonomics principles in the design and selection of office furniture.

BS EN ISO 9241-5: 1999
Ergonomic requirements for office work with visual display terminals.

BS 8300: 2001
Design of buildings and their approaches to meet the needs of disabled people - Code of practice. (DDA compliance).

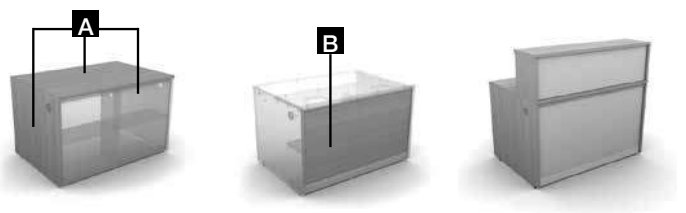

A Select end and top finish from MFC colours.

B Silver and White front finish on straight and curved units.

MODULAR RECEPTION UNITS DESKING

10 Year
Guarantee

Desking



Full panel



Cut back right panel



Cut back left panel



Cut back left & right panel

Code A B C Price



Straight base unit - full panel

ASB16FF	1600	x	800		£1,491
ASB14FF	1400	x	800		£1,388
ASB12FF	1200	x	800		£1,281
ASB10FF	1000	x	800		£1,171
ASB08FF	800	x	800		£1,069



Straight base unit - cut back left & right panels

ASB16II	1600	x	800		£1,491
ASB14II	1400	x	800		£1,388
ASB12II	1200	x	800		£1,281
ASB10II	1000	x	800		£1,171
ASB08II	800	x	800		£1,069

Code A B C Price



Straight base unit - cut back right hand panel

ASB16FIR	1600	x	800		£1,491
ASB14FIR	1400	x	800		£1,388
ASB12FIR	1200	x	800		£1,281
ASB10FIR	1000	x	800		£1,171
ASB08FIR	800	x	800		£1,069



Straight base unit - cut back left hand panel

ASB16FIL	1600	x	800		£1,491
ASB14FIL	1400	x	800		£1,388
ASB12FIL	1200	x	800		£1,281
ASB10FIL	1000	x	800		£1,171
ASB08FIL	800	x	800		£1,069



Full panel



Cut back right panel



Cut back left panel



Cut back left & right panel



Radial base unit - full panel

90° ARB90FF	1838	x	800	x	1300	£1,802
60° ARB60FF	1300	x	800	x	1300	£1,779



Radial base unit - cut back left & right panels

90° ARB90II	1838	x	800	x	1300	£1,802
60° ARB60II	1300	x	800	x	1300	£1,779



Radial base unit - cut back right hand panel

90° ARB90FIR	1838	x	800	x	1300	£1,802
60° ARB60FIR	1300	x	800	x	1300	£1,779



Radial base unit - cut back left hand panel

90° ARB90FIL	1838	x	800	x	1300	£1,802
60° ARB60FIL	1300	x	800	x	1300	£1,779



Cut back right panel



Cut back left panel



Cut back left & right panel



Corner unit - cut back right hand panel

Unit supplied without shelf.

90° ARB00FIR	1131	x	800	x	800	£1,760
--------------	------	---	-----	---	-----	--------



Corner unit - cut back left hand panel

Unit supplied without shelf.

90° ARB00FIL	1131	x	800	x	800	£1,760
--------------	------	---	-----	---	-----	--------



Corner unit - cut back right & left hand panel

Unit supplied without shelf.

90° ARB00II	1131	x	800	x	800	£1,760
-------------	------	---	-----	---	-----	--------





Radial inverted base unit



Radial DDA base unit



Straight DDA base unit

Code	A	B	C	Price		
 Radial inverted base unit						
90° AIRB90FF	1838	x	800	x	1300	£1,802
60° AIRB60FF	1300	x	800	x	1300	£1,779
 Radial DDA base unit supplied without shelf.						
90° ARD90	1838	x	800	x	1300	£1,589
60° ARD60	1300	x	800	x	1300	£1,564

Code	A	B	C	Price	
 Straight DDA base unit supplied without shelf.					
ASD16	1600	x	800		£1,491
ASD14	1400	x	800		£1,388
ASD12	1200	x	800		£1,265
ASD10	1000	x	800		£1,171
ASD08	800	x	800		£1,068



Full panel



Cut back right hand panel





Cut back left hand panel



Cut back left & right hand panel

Code	A	B	Price	
 Straight base unit with wooden file hutch - full panel supplied as complete unit, file hutches are 300mm deep x 355mm high.				
AST16FF	1600	x	800	£2,200
AST14FF	1400	x	800	£2,063
AST12FF	1200	x	800	£1,921
AST10FF	1000	x	800	£1,782
AST08FF	800	x	800	£1,648

Code	A	B	Price	
 Straight base unit with wooden file hutch - cut back right hand panel supplied as complete unit, file hutches are 300mm deep x 355mm high.				
AST16FIR	1600	x	800	£2,200
AST14FIR	1400	x	800	£2,063
AST12FIR	1200	x	800	£1,921
AST10FIR	1000	x	800	£1,782
AST08FIR	800	x	800	£1,648

Code	A	B	Price	
 Straight base unit with wooden file hutch - cut back left hand panel supplied as complete unit, file hutches are 300mm deep x 355mm high.				
AST16FIL	1600	x	800	£2,200
AST14FIL	1400	x	800	£2,063
AST12FIL	1200	x	800	£1,921
AST10FIL	1000	x	800	£1,782
AST08FIL	800	x	800	£1,648

Code	A	B	Price	
 Straight base unit with wooden file hutch - cut back left & right hand panels supplied as complete unit, file hutches are 300mm deep x 355mm high.				
AST16FII	1600	x	800	£2,200
AST14FII	1400	x	800	£2,063
AST12FII	1200	x	800	£1,921
AST10FII	1000	x	800	£1,782
AST08FII	800	x	800	£1,648



Full panel



Cut back right hand panel





Cut back left hand panel



Cut back left & right hand panel

Code	A	B	Price	
 Straight base unit with wooden counter top - full panel wooden counter top height - 1035mm.				
ASW16FF	1600	x	800	£1,631
ASW14FF	1400	x	800	£1,532
ASW12FF	1200	x	800	£1,427
ASW10FF	1000	x	800	£1,317
ASW08FF	800	x	800	£1,213

Code	A	B	Price	
 Straight base unit with wooden counter top - cut back right hand panel wooden counter top height - 1035mm.				
ASW16FIR	1600	x	800	£1,631
ASW14FIR	1400	x	800	£1,532
ASW12FIR	1200	x	800	£1,427
ASW10FIR	1000	x	800	£1,317
ASW08FIR	800	x	800	£1,213

Code	A	B	Price	
 Straight base unit with wooden counter top - cut back left hand panel wooden counter top height - 1035mm.				
ASW16FIL	1600	x	800	£1,631
ASW14FIL	1400	x	800	£1,532
ASW12FIL	1200	x	800	£1,427
ASW10FIL	1000	x	800	£1,317
ASW08FIL	800	x	800	£1,213

Code	A	B	Price	
 Straight base unit with wooden counter top - cut back left & right hand panels wooden counter top height - 1035mm.				
ASW16II	1600	x	800	£1,631
ASW14II	1400	x	800	£1,532
ASW12II	1200	x	800	£1,427
ASW10II	1000	x	800	£1,317
ASW08II	800	x	800	£1,213

MODULAR RECEPTION UNITS DESKING

10 Year
Guarantee

Desking



Full panel



Cut back right hand panel



Cut back left hand panel



Cut back left & right hand panel



Straight base unit with glass counter top - full panel
glass counter top height - 1025mm.

ASG16FF	1600	x	800		£2,661
ASG14FF	1400	x	800		£2,553
ASG12FF	1200	x	800		£2,445
ASG10FF	1000	x	800		£2,339
ASG08FF	800	x	800		£2,229



Straight base unit with glass counter top - cut back right hand panel
glass counter top height - 1025mm.

ASG16FIR	1600	x	800		£2,661
ASG14FIR	1400	x	800		£2,553
ASG12FIR	1200	x	800		£2,445
ASG10FIR	1000	x	800		£2,339
ASG08FIR	800	x	800		£2,229



Straight base unit with glass counter top - cut back left hand panel
glass counter top height - 1025mm.

ASG16FIL	1600	x	800		£2,661
ASG14FIL	1400	x	800		£2,553
ASG12FIL	1200	x	800		£2,445
ASG10FIL	1000	x	800		£2,339
ASG08FIL	800	x	800		£2,229



Straight base unit with glass counter top - cut back left & right hand panels
glass counter top height - 1025mm.

ASG16FII	1600	x	800		£2,661
ASG14FII	1400	x	800		£2,553
ASG12FII	1200	x	800		£2,445
ASG10FII	1000	x	800		£2,339
ASG08FII	800	x	800		£2,229



Cut back right hand panel



Cut back left hand panel



Cut back left & right hand panel



Corner unit with wooden counter top - cut back right hand panel
supplied without shelf

90° ARW00FIR	1131	x	800	x	800	£2,149
--------------	------	---	-----	---	-----	--------



Corner unit with wooden counter top - cut back left & right hand panel
supplied without shelf.

90° ARW00FII	1131	x	800	x	800	£2,149
--------------	------	---	-----	---	-----	--------



Corner unit with wooden counter top - cut back left hand panel
supplied without shelf

90° ARW00FIL	1131	x	800	x	800	£2,149
--------------	------	---	-----	---	-----	--------



MODULAR RECEPTION UNITS DESKING



Full panel



Cut back right hand panel



Cut back left hand panel



Cut back left & right hand panel

Code	A	B	C	Price
------	---	---	---	-------



Radial base unit with wooden counter top - full panel
wooden counter top height - 1035mm.

90° ARW90FF	1838	x	800	x	1300	£2,192
60° ARW60FF	1300	x	800	x	1300	£2,172

Code	A	B	C	Price
------	---	---	---	-------



Radial base unit with wooden counter top - cut back right hand panel
wooden counter top height - 1035mm.

90° ARW90FIR	1838	x	800	x	1300	£2,192
60° ARW60FIR	1300	x	800	x	1300	£2,172

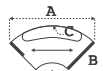

Radial base unit with wooden counter top - cut back left hand panel
wooden counter top height - 1035mm.

90° ARW90FIL	1838	x	800	x	1300	£2,192
60° ARW60FIL	1300	x	800	x	1300	£2,172



Radial base unit with wooden counter top - cut back left & right hand panels
wooden counter top height - 1035mm.

90° ARW90II	1838	x	800	x	1300	£2,192
60° ARW60II	1300	x	800	x	1300	£2,172



Full panel



Cut back right hand panel



Cut back left hand panel



Cut back left & right hand panel

Code	A	B	C	Price
------	---	---	---	-------



Radial base unit with glass counter top - full panel
glass counter top height - 1025mm

90° ARG90FF	1838	x	800	x	1300	£2,966
60° ARG60FF	1300	x	800	x	1300	£2,909

Code	A	B	C	Price
------	---	---	---	-------



Radial base unit with glass counter top - cut back right hand panel
glass counter top height - 1025mm

90° ARG90FIR	1838	x	800	x	1300	£2,966
60° ARG60FIR	1300	x	800	x	1300	£2,909

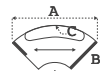

Radial base unit with glass counter top - cut back left hand panel
glass counter top height - 1025mm.

90° ARG90FIL	1838	x	800	x	1300	£2,966
60° ARG60FIL	1300	x	800	x	1300	£2,909



Radial base unit with glass counter top - cut back left & right hand panel
glass counter top height - 1025mm.

90° ARG90FF	1838	x	800	x	1300	£2,966
60° ARG60FF	1300	x	800	x	1300	£2,909



Cut back right hand panel



Cut back left hand panel



Cut back left & right hand panel



Corner unit with glass counter top - cut back right hand panel
supplied without shelf.

90° ARG00FIR	1131	x	800	x	800	£2,345
--------------	------	---	-----	---	-----	--------



Corner unit with glass counter top - cut back left & right hand panel
supplied without shelf.

90° ARG00II	1131	x	800	x	800	£2,345
-------------	------	---	-----	---	-----	--------



Corner unit with glass counter top - cut back left hand panel
supplied without shelf.

90° ARG00FIL	1131	x	800	x	800	£2,345
--------------	------	---	-----	---	-----	--------

CABLE MANAGEMENT DESKING

Universal Cable Management



Cable Baskets can fit on suspension brackets in two positions.

1. To accommodate tall under desk pedestals under tray.
2. To accommodate transformer plugs in tray.

Baskets can be unhooked from suspension brackets on one side to provide easy access to cables and modules.

Code	Desk Size	L	W	Price
------	-----------	---	---	-------

Cable Baskets for single sided desks

MECT20	2000	1832	116	£88
MECT18	1800	1629	116	£86
MECT16	1600	1426	116	£82
MECT14	1400	1222	116	£81
MECT12	1200	1019	116	£76
MECT10	1000	816	116	£73
MECT08	800	612	116	£71

Code	Desk Size	L	W	Price
------	-----------	---	---	-------

Cable Baskets for double sided desks

MECT20D	2000	1832	336	£132
MECT18D	1800	1629	336	£128
MECT16D	1600	1426	336	£122
MECT14D	1400	1222	336	£121
MECT12D	1200	1019	336	£114
MECT10D	1000	816	336	£109
MECT08D	800	612	336	£107

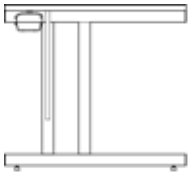

Cable basket fitting (Desklet cantilever and panel ended desks)

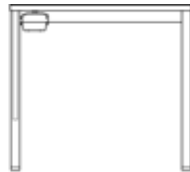

Cable basket fitting (Bench Desklet desks)

Desklet Endframe Covers



Outer Covers

Where Used

RH 800mm Endframe
LH 800mm Endframe
RH 600mm Endframe
LH 600mm Endframe

	D3K Desklets	X10	Design 2000 Cantilever	Price
GRECR	KNRECR	8ECR	£40	
GLECR	KNLECR	8ECR	£40	
GSECR	KNRECR	8ECR	£40	
GSECR	KNRECR	8ECR	£40	

Inner Covers

Description

Inner cover, cable restraints & plastic cable trunking inc. Requires outer covers for fitting.

	D3K Desklets	X10	Design 2000 Cantilever	Price
GERI	KNERI	8ERI	£40	

Cable Spine

ø60 x 700h

Code	Colour	Price
BCRB	Black	£82
BCRS	Silver	£82
BCRW	White	£82



Design 2000 Desklet Outer Cover



X10 Desklet Outer Cover



D3K Desklet Outer Cover

ELECTRICAL INSTALLATION GUIDE

DESKING

Electrical Installations within Office Furniture, Educational Furniture and Office Screens

This information is intended to help when specifying power distribution systems in furniture and is based on BS 6396: 2008 + A1 2015. Please refer to this standard for more information. It is recommended that all installations be completed by a suitably skilled person and that all equipment meets the pertinent standard criteria.

Examples shown are based on single-phase electrical distribution system with rated voltages up to 250 V a.c. connected to the building's supply by a 13A UK plug, conforming to BS 1363.

Under Desk Modules

When individually fused at **5 A max.**, no more than four sockets can be connected to a 13A single supply lead. These can be made-up of single 4-gang modules or 2-gang units connected with a lead.

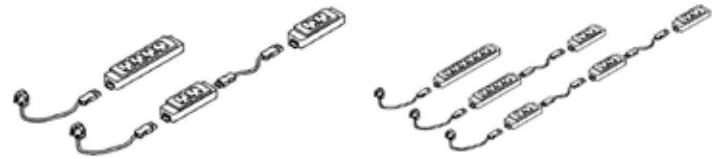

When individually fused at **3.15 A max.**, no more than six sockets can be connected to a 13A single supply lead. These can be made-up of single 6-gang modules, 4-gang or 2-gang units connected with leads.

Under and On Desk Modules

When individually fused at **5 A max.**, no more than four sockets can be connected to a 13A single supply lead. These can be made-up of single 4-gang modules or 2-gang units connected with leads.

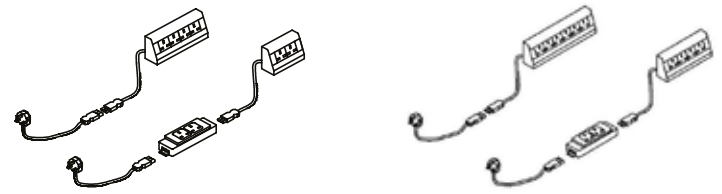

When individually fused at **3.15 A max.**, no more than six sockets can be connected to a 13A single supply lead. These can be made-up of single 6-gang modules, 4-gang or 2-gang units connected with leads and connector blocks.

Under desk modules that are fitted with data outlets cannot be interconnected.

Through-Desk Modules

When including UK power sockets, follow the same rules as under and on-desk outlets. Consideration should also be given to the overall cost. If there are enough sockets for the starter cables, then it may be simpler and more cost effective to use starter leads than connecting to a single starter cable using connector leads and blocks.

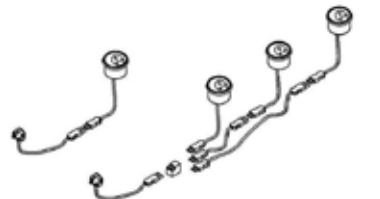

USB Charging Modules

These units only provide a fraction of the current compared to UK power sockets and when used separately from other outlets can be 'daisy-chained' together to a maximum of **60 No. units** from one starter lead, connector leads and blocks. Best practice is to reduce the amount of connectors where possible.

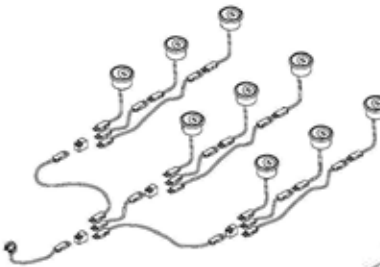

On selected modules, twin USB fast charge now consist of a USB-A and a USB-C socket. The USB Type C connector is now being adopted by all the major manufacturers of mobile devices (phones, tablets, etc) and has already been incorporated into some laptops. This is not only because of its small form factor and the fact that it is reversible, making it simpler and easier to use, but also because it enables significantly faster charging than was possible with the USB Type A connector, whilst at the same time (for relevant devices) replacing all former AV/data connections, such as VGA, HDMI, USB-A, RJ45.

Where shown, modules with a twin USB outlet will provide both the new USB-C port, for enhanced fast charging of compatible devices, plus a USB-A for charging legacy devices - suiting users with any USB powered device old. ® Denotes new style reversible Type A & Type C fast charge with replaceable cartridge.

Exposed Power Cables

When all the outlets are connected and the Starter Cable is plugged into a power supply, any exposed length of supply cord must not exceed **2 metres** in length.

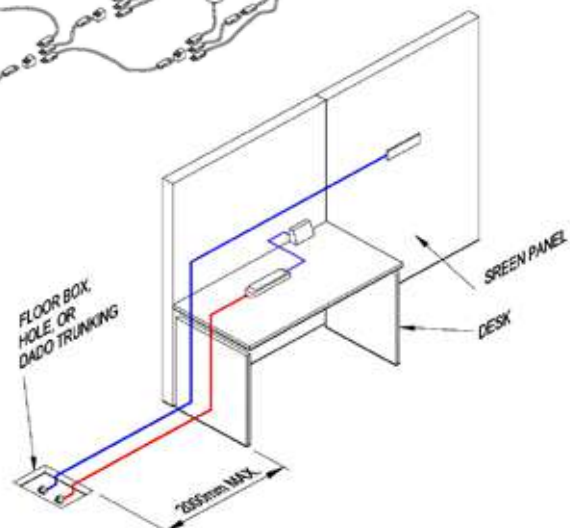

ELECTRICAL ACCESSORIES

DESKING

On and In Desk Modules

All on-desk or in-desk modules containing electrical outlets are supplied with a short lead to a male Wieland GST plug. These can be connected to an under-desk module, a connector lead / block or a starter cable – sold separately. Data modules, including RJ45, HDMI & data USB are hardwired to a 3 metre lead fitted with an appropriate connector.

Under Desk Modules

All under desk modules require a connector lead or a starter cable.

Please check with our Sales Department for fitting Power Modules to Bench Desksits.

Safe Electrical Wiring

For all types of power modules, please refer to the installation guidelines.

Where Used

The icons shown indicate where modules can be used:



Desks



Tables



Seating

Outlet Types/Quantities



UK POWER



CAT 5e DATA



CAT 6 DATA



2x USB-A
FAST CHARGE

Code

Code	UK POWER	CAT 5e DATA	CAT 6 DATA	2x USB-A FAST CHARGE	Price
DTPMX-10	2	1	-	-	£129
DTPMX-20	2	-	1	-	£141
DTPMX-30	2	2	-	-	£159
DTPMX-40	2	-	2	-	£187
DTPMX-50	4	2	-	-	£189
DTPMX-60	4	-	2	-	£220
DTPMX-70	2	-	-	1	£202
DTPMX4	4	-	-	-	£147
DTPMX	2	-	-	-	£116

Available in White finish

Cut-Outs - Required in worksurface to fit module

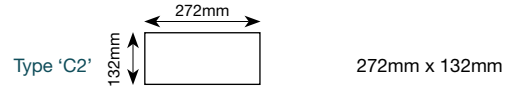
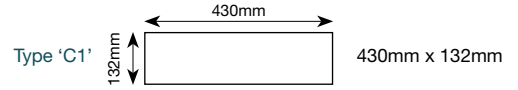

ELECTRICAL ACCESSORIES DESKING

Code	Outlet Types/Quantities				Cut out	Price
	UK POWER	CAT 5e DATA	CAT 6 DATA	TWIN USB FAST CHARGE		
DTPX	1	-	-	-	P	£150
DTPX02U	-	-	-	1	P	£247
DTPXD5	1	1	-	-	P	£219
DTPXD6	1	-	1	-	P	£220
DTPXH	1	-	-	-	P	£369
DTPXT	1	-	-	1	P	£301
DTPX-10	1	2	-	-	P	£238
DTPX-20	1	-	2	-	P	£318
DTPX-30	-	2	-	1	P	£332
DTPX-40	-	-	2	1	P	£413
DTPX-50	1	1	-	-	P	£419
DTPX-60	1	-	1	-	P	£456

Available in Silver surround with Black or White fascia



Code	Outlet Types/Quantities				Cut out	Price
	UK POWER	CAT 5e DATA	CAT 6 DATA	TWIN USB FAST CHARGE		
DTPPT03	3	-	-	-	P	£259
DTPPT02U	2	-	-	1	P	£361
DTPPT02D5	2	2	-	-	P	£328
DTPPT02D6	2	-	2	-	P	£433
DTPPT-10	1	2	-	1	P	£448
DTPPT-20	1	-	2	1	P	£507

Available in White or Black finish.

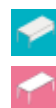

ELECTRICAL ACCESSORIES

DESKING

Desking

Code	Outlet Types/Quantities							Cut Out	Price
	UK POWER	CAT 5e DATA	CAT 6 DATA	TWIN USB FAST CHARGE® 1x USB-A 1x USB-C	VGA & AUDIO	HDMI	SINGLE USB DATA		
DTPLA-10	2	-	-	-	-	-	-	C3	£289
DTPLA-20	2	1	-	-	-	-	-	C2	£358
DTPLA-30	2	-	1	-	-	-	-	C2	£372
DTPLA-40	2	2	-	1	-	-	-	C2	£511
DTPLA-50	2	-	2	1	-	-	-	C2	£600
DTPLA-60	4	-	-	-	-	-	-	C1	£408
DTPLA-70	2	2	-	-	1	1	-	C1	£984
DTPLA-80	2	-	2	-	1	1	-	C1	£1,070
DTPLA-90	4	2	-	-	-	-	-	C1	£500
DTPLA-100	4	-	2	-	-	-	-	C1	£584
DTPLA-110	4	2	-	-	1	-	-	C1	£880
DTPLA-120	4	-	2	-	1	-	-	C1	£962
DTPLA-130	4	4	-	-	-	-	-	C1	£601
DTPLA-140	4	-	4	-	-	-	-	C1	£767
DTPLA-150	2	2	-	-	1	-	-	C2	£762
DTPLA-160	2	-	2	-	1	-	-	C2	£849
DTPLA-170	2	2	-	1	1	1	-	C1	£1,116
DTPLA-180	2	-	2	1	1	1	-	C1	£1,198
DTPLA-190	2	2	-	-	1	2	-	C1	£1,131
DTPLA-200	3	-	-	-	1	1	-	C1	£900
DTPLA-210	2	1	-	-	-	1	-	C2	£637
DTPLA-220	3	1	-	-	-	1	-	C1	£728
DTPLA-230	3	-	1	-	-	1	-	C1	£769
DTPLA-240	3	-	2	-	1	1	-	C1	£1,037
DTPLA-250	4	2	-	-	-	1	-	C1	£800
DTPLA-260	4	-	2	-	-	2	-	C1	£1,037
DTPLA-270	3	1	-	-	-	-	-	C1	£424
DTPLA-280	2	4	-	-	-	1	1	C1	£901
DTPLA-290	2	2	-	-	-	1	-	C2	£689
DTPLA-300	1	1	-	-	1	1	2	C1	£1,002
DTPLA-310	2	2	-	-	1	1	2	C1	£1,081
DTPLA-320	2	-	-	-	1	1	-	C2	£813
DTPLA-330	3	-	-	-	-	-	-	C2	£309
DTPLA-340	2	-	-	-	-	1	1	C2	£620
DTPLA-350	1	1	-	-	1	1	-	C2	£822
DTPLA-360	2	2	-	-	1	1	1	C1	£1,031
DTPLA-370	2	-	-	1	-	1	-	C2	£716
DTPLA02U	2	-	-	1	-	-	-	C2	£421
DTPLA02D5	2	2	-	-	-	-	-	C2	£367
DTPLA02D6	2	-	2	-	-	-	-	C2	£429
DTPLA01VA	2	-	-	-	1	-	-	C2	£630
DTPLA02H	2	-	-	-	-	-	2	C2	£817



Available in Silver finish.

Examples

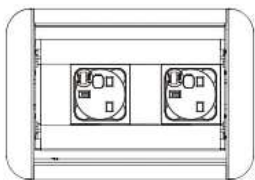

DTPLA-10

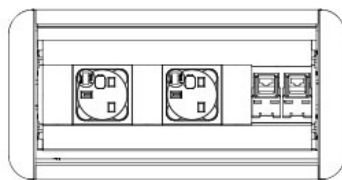

DTPLA02D5

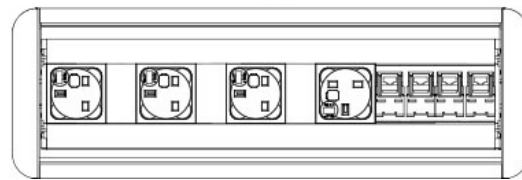

DTPLA-130

Code	Outlet Types/Quantities			Price
	UK POWER	CAT 6 DATA	TWIN USB FAST CHARGE 1x USB-A 1x USB-C	
DTPUNO-10	2	-	1	£209
DTPUNO-20	2	*2	1	£266



Modules are available in either Black or White
Units have illuminated switches and fitted with an integrated thermal reset switch instead of fuses.
* Data modules are supplied as coupler to allow for separate patch lead (not supplied)

ELECTRICAL ACCESSORIES

DESKING

Code	Outlet Types/Quantities				Price
	UK POWER	CAT 5e DATA	CAT 6 DATA	TWIN USB FAST CHARGE®	
DTPMP	2	-	-	-	£205
DTPMP4	4	-	-	-	£273
DTPMP-10	2	-	-	1	£380
DTPMP-20	2	2	-	-	£340
DTPMP-30	2	-	2	-	£422
DTPMP-40	1	2	-	1	£442
DTPMP-50	1	-	2	1	£522
DTPMP-60	1	-	-	1	£327
DTPMP-70	2	2	-	1	£476
DTPMP-80	2	-	2	1	£554



Available in White or Black finish.

Code	Outlet Types/Quantities				Price
	UK POWER	CAT 5e DATA	CAT 6 DATA	TWIN USB FAST CHARGE®	
DTPMS	2	-	-	-	£128
DTPMS4	4	-	-	-	£185
DTPMS-10	2	-	-	1	£287
DTPMS-20	2	2	-	-	£228
DTPMS-30	2	-	2	-	£309
DTPMS-40	1	2	-	1	£363
DTPMS-50	1	-	2	1	£445
DTPMS-60	1	-	-	1	£246
DTPMS-70	2	2	-	1	£388
DTPMS-80	2	-	2	1	£471



Available in Silver, White or Black finish.

DTPMSBKT	Surface mounted fixing bracket kit (screw fixes to work surface)	£34
----------	--	-----



DTPUNO-20

ELECTRICAL ACCESSORIES

DESKING

Desking

Aircharge Induction Charging Modules - Qi Compatible.

Induction charging units for mobile phones - supplied with 3 metre lead to USB connector - supplied with UK 3 Pin Adaptor. Requires cut-out in furniture



DTPCA
Module with Black Inner & Aluminium Bezel Cut Out P

£227



DTPCB
Module with Black Inner & Black Bezel Cut Out P

£186



TDP15
iPhone 5 Charging Case

£73



TDP16
iPhone 6 Charging Case

£73



TDP15
Wireless Charge Receiver supplied with Apple 30 pin, Lightning & Micro USB Connectors

£64



TDPUP
USB / UK Main Plug

£25



TDPUH4
4 x USB Hub. Can be used to power up to 4 Aircharge Modules from one supply

£113

Outlet Types/Quantities

Code	UK POWER	CAT 5e DATA	CAT 6 DATA PULL THROUGH	1x USB-A SINGLE USB FAST CHARGE	Qi CHARGE	Cut out	Price
DTPEV-10	1	-	-	2	-	P	£246
DTPEV-20	1	-	-	1	1	P	£407
DTPEV-30	1	-	1	1	1	P	£496



Modules are available in either Black or White
RDM CAT 6 Pull Through data connectors are supplied with 0.5 metre leads.



EVOLINE DTPEV-30

ELECTRICAL ACCESSORIES

DESKING

Under Desk Modules

All under desk modules require a connector lead or a starter cable.

Safe Electrical Wiring

For all types of power modules, please refer to the installation guidelines.

Where Used

The icons shown indicate where modules can be used:



Desks



Tables



Seating

Outlet Types/Quantities



Code

PM
PM4
PM6

2
4
6

Price

£42
£64
£74



Code

Description

Price

Interconnecting Cables (GST18/3 Male to Female)

CL500
CL1500
CL3000
CL5000

500mm
1500mm
3000mm
5000mm

£22
£25
£30
£37

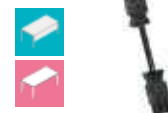

Starter Cables (GST18/3 Female to 13A Plug)

CLWP1
CLWP2
CLWP3
CLWP5
CLWP7

1000mm
2000mm
3000mm
5000mm
7000mm

£30
£32
£32
£39
£48



ST to GST Adaptor (Converts ST Cables to GST)

CLA

-

£10



Connector Blocks

CLA3
CLA5

3-Way (1 Male /3 Female)
5-Way (1 Male /5 Female)

£32
£32



MONITOR ARMS & ACCESSORIES

DESKING

Monitor Arms

A selection of single and twin arm monitor holders that will fit to the rear of worksurfaces and clamp into place or alternatively be attached through the worksurface. Please state required colour when ordering. Please check with our Sales Department for fitting Power Modules to Bench Deskits.

Clamp	Through Desk	Description	Price	
BAMA0	BFMA0	Manual height adjustable. 180° swivel with 508mm reach. Max load 10kg. Available in Silver, White or Black finish.	£202	
BAMA0-2	BFMA0-2	Twin arm manual height adjustable. 180° swivel with 508mm reach. Max load 10kg. Available in Silver, White or Black finish.	£335	
BAMA4	BFMA4	Dynamic gas height adjustable. 180° swivel with 570mm reach. Max load 9kg. Available in Silver or White finish.	£304	
BAMA6-2	N/A	Dynamic arm with 'technical chord' height adjustable lift fitted with Dual Mount Bar Maximum load 9Kg. 180° swivel with 670mm max. span between monitor centres. Available in Black, Silver or White finishes.	£526	
BAMA5	BFMA5	Gas assisted height adjustable. 180° swivel with 600mm reach. Max load 8kg *requires either Ø80 cable port or Ø12mm hole through worksurface, with clearance beneath. Available in Silver, White or Black finish.	£358	
BAMA5-2	BFMA5-2	Twin arm dynamic gas height adjustable. 180° swivel with 600mm reach. Max load 8kg. Available in Silver, White or Black finish.	£649	

MONITOR ARMS & ACCESSORIES

DESKING

BAMA6 Clamp Options

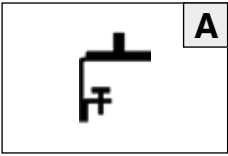

Split Desk Clamp

For use where there is limited access to the edges of the desk surface. Can be completely disassembled to make installation easier. Fits desk thickness from 0mm to 65mm (2½").

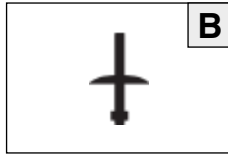

Through Desk Clamp

For use in a Grommet hole or where drilling through the desk surface is possible. Fits desk thickness from 10mm (½") to 35mm (1 ⅓").

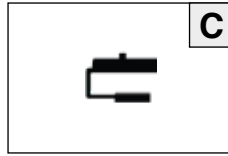







Top Mount Clamp

For use on desks with sliding worktops or where it is not possible or desirable to drill through the desk surface. Range of standard clamps to fit desk thickness from 12mm (½") to 25mm (1").



MONITOR ARMS & ACCESSORIES

DESKING

Clamp	Through Desk	Description	Price	
BAMA7	BFMA7	Manual height adjustable. 180° swivel with 410mm reach. 400mm high pole with quick release. Max load 10kg. Cable management. Available in Silver, White or Black finish.	£151	
BAMA7-2	BFMA7-2	Twin arm manual height adjustable. 180° swivel with 410mm reach. 400mm high pole with quick release. Max load 10kg each. Cable management. Available in Silver, White or Black finish.	£232	
BAMA7-3	BFMA7-3	Triple arm manual height adjustable. 180° swivel with 410mm reach. 400mm high pole with quick release. Max load 10kg each. Cable management. Available in Silver, White or Black finish.	£410	
BAMA7-4	BFMA7-4	Quad arm manual height adjustable. 180° swivel with 410mm reach. 700mm high pole with quick release. Max load 10kg each. Cable management. Available in Silver, White or Black finish.	£485	
BAMA08	BFMA08	Quick release VESA mounting plate Quick release height adjustment Complete cable management Includes pre-assembled clamp and through desk fixing Available in black, silver and white from stock	£225	
BAMA08-2	BFMA08-2	Twin Arm, quick release VESA mounting plate 180° swivel with 385mm reach. Quick release height adjustment Complete cable management Includes pre-assembled clamp and through desk fixing Available in black, silver and white from stock	£369	

MONITOR ARMS & ACCESSORIES DESKING

CPU Holder - Adjustable

Code

Bench ²	Script	Mesa
BCPUH1	XCPU1	MECPUH1

Description

Fits CPU 90mm wide x 290mm high to 240mm wide x 510mm high. Adjustable between stops using an Allen key. CPU clamps into place. Available in Silver finish.

Price

£229



Loop CPU Holder

CPUL1

Simple, light and effective CPU holder. With minimalist black strap, integrates seamlessly with the desk. Fully adjustable, Easy to install with universal mounting rotating bracket, CPU is supported by webbing which is easily tightened by a ratchet mechanism. Fits CPU 80mm wide x 240mm high to 225mm wide x 500mm high.

Price

£142



CPUL1 Loop Holder

INTRODUCTION

TABLES

Tables

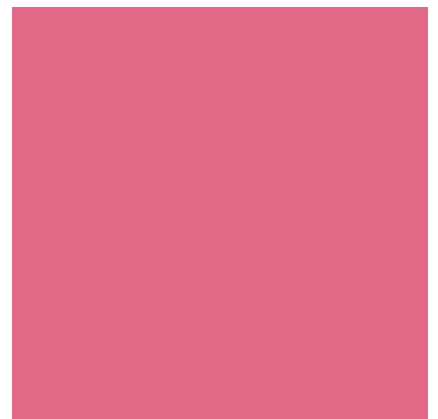
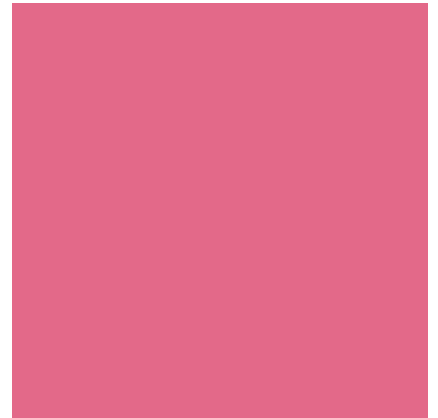
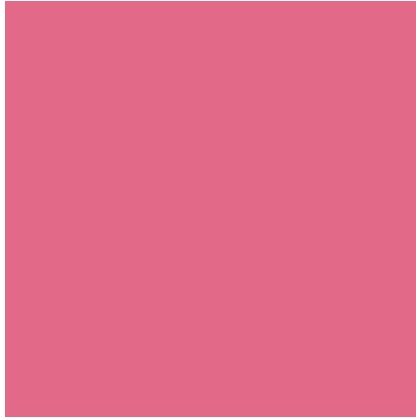

KEY TABLES



For optional cable management please refer to relevant product page or Cable Management in Desking section.



For optional desk service modules please see Electrical Accessories in Desking section.



For metal finishes please see Technical Information section.

Pastel Paint Surcharge = £32 per item.



For board finishes please see Technical Information section.

Adlington Oak Surcharge = £64 per item
Light Concrete Surcharge = £64 per item

Tables

- A selective range of tables are available with 25mm and 36mm top panels (see opposite). Suffix code with relevant letter for required finish. Please refer to the technical information section for available colours. Only top panels are available in different finishes, all other components remain unaffected.

Group Z	Squared Edged 25mm MFC
Group B	Squared Edged 36mm MFC
Group C	Squared Edged 25mm Laminate Face
Group D	25mm MDF Laminate Face with Chamfered Edge
Group F	Square Edged 25mm MDF Dry Wipe Laminate Face
Group G	Squared Edged 36mm Laminate Face

Edging Options

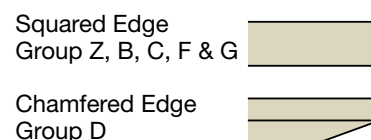

Laminate prices shown are for our Kiko range of laminates. Halo, Fenix and Filaflo laminates are available for a surcharge.

- Selected tables can be specified with 80 diameter circular cable ports or cut outs that can be used to access either cable trays or spines beneath the worksurface. They are positioned to avoid the underframes and can be fitted with a selection of service modules - specified separately.

Please refer to the relevant cable management section and Electrical Accessories section for further information.

Surcharge for Cable Ports: £35 retail

No surcharge for standard cut outs



How to order Tables with/for power modules:

- Choose required power module.
- Make a note of the code & type of opening required (P, C1, C2 etc).
- Choose table range.
- Refer to cable management section to see available cut out type and positions for the range.

5) Make a note of the required table code with relevant cut out details (GTR2010ZC2 for example).

6) Place order with relevant table and module code.

Note: cut out positions not shown may not be available due to frame restraints.



C1, C2, C3
(cut out)



P
(cable port)
(surcharge £35)

- Unless otherwise stated tables are 727mm high when fitted with 25mm MFC top panels.

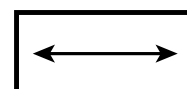

denotes grain direction

- LTF, LTC, LTA and LTD tables are available in a range of heights (see opposite).



Coffee - 455mm



Lounge - 575mm

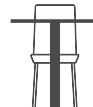

Dining - 745mm

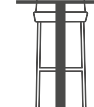

Mid poseur - 905mm

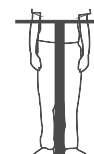

Poseur - 1125mm
1105mm

Betibo Blu

A member of the Betibo coffee table family, the Blu Table sits best at a room's centre. Whether in a lounge, casual meeting space or reception area, the low-level design sits at the ideal height for practicality. From drinks to documents, the two pieces in this range (800x800x330 and 1200x800x330) offer subtle support. Choose from leg options including Oak Stained, Black Stained and Dark Walnut. And tabletops with either a radius or square corner, and in our standard MFC or a laminate finish.

Available Frame Colours

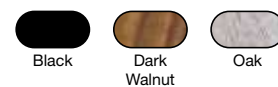

Corner Options

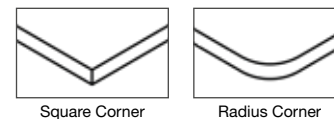

Code	Description	Corner Style	Dimensions	Height	Format	Price
BEC008RS	Betibo Blu CoffeeTable	Square	800 x 800	330	Square	£576
BEC008RR	Betibo Blu CoffeeTable	Radius	800 x 800	330	Square	£639
BEC012RS	Betibo Blu CoffeeTable	Square	1200 x 800	330	Rectangular	£627
BEC012RR	Betibo Blu CoffeeTable	Radius	1200 x 800	330	Rectangular	£691



10 Year
Guarantee

NEW
PRODUCT

BETIBO TABLES

Tables



BEC008RS
Betibo Blu
SQUARE



BEC008RR
Betibo Blu
RADIUS



BEC012RS
Betibo Blu
SQUARE



BEC012RR
Betibo Blu
RADIUS



BEX400CS
Betibo Baku
N/A



BEX500CS
Betibo Baku
N/A



BEX750CS
Betibo Baku
N/A



BEX400SS
Betibo Baku
SQUARE



BEX400SR
Betibo Baku
RADIUS



BEX500SS
Betibo Baku
SQUARE



BEX500SR
Betibo Baku
RADIUS



BEX750SS
Betibo Baku
SQUARE



BEX750SR
Betibo Baku
RADIUS



BED008RS
Betibo Barrier
SQUARE



BED008RR
Betibo Barrier
RADIUS



BED012RS
Betibo Barrier
SQUARE



BED012RR
Betibo Barrier
RADIUS



BED016RS
Betibo Barrier
SQUARE



BED016RR
Betibo Barrier
RADIUS



BED018RS
Betibo Barrier
SQUARE



BED018RR
Betibo Barrier
RADIUS



BEP008RS
Betibo Barrier
SQUARE



BEP008RR
Betibo Barrier
RADIUS



BEP018RS
Betibo Barrier
SQUARE



BEP018RR
Betibo Barrier
RADIUS

Betibo Baku

The Baku Table – part of the Betibo family of coffee tables - was designed with contemporary spaces in mind. Minimal in aesthetic, the highly versatile pieces suit any interior setting, bringing people together, whether in a work, social or family context. Use as a standalone solution or combine multiple sizes and heights to create a functional feature. Leg options include Oak Stained, Black Stained and Dark Walnut. And tabletops come with either a radius or square corner, and with our standard MFC or laminate finish.

Available Frame Colours

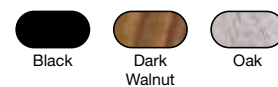

Corner Options

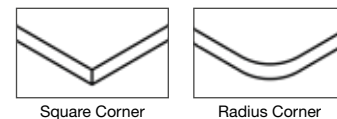

Code	Description	Corner Style	Dimensions	Height	Format	Price
BEX400CS	Betibo Baku X Leg Table	N/A	D590	400	Circular	£343
BEX500CS	Betibo Baku X Leg Table	N/A	D590	500	Circular	£361
BEX750CS	Betibo Baku X Leg Table	N/A	D590	750	Circular	£416
BEX400SS	Betibo Baku X Leg Table	Square	590 x 590	400	Square	£319
BEX400SR	Betibo Baku X Leg Table	Radius	590 x 590	400	Square	£382
BEX500SS	Betibo Baku X Leg Table	Square	590 x 590	500	Square	£337
BEX500SR	Betibo Baku X Leg Table	Radius	590 x 590	500	Square	£401
BEX750SS	Betibo Baku X Leg Table	Square	590 x 590	750	Square	£393
BEX750SR	Betibo Baku X Leg Table	Radius	590 x 590	750	Square	£457





Betibo Barrier

Further bolstering the Betibo family of coffee table solutions, the Betibo Barrier Table in dining and poseur height options allows you total flexibility. In the workplace, the regular style makes the perfect meeting table. And in a hospitality venue, the taller format pairs with stool seating to offer a casual yet comfortable arrangement. The dining tables range from 800x800x730 to 1800x800x730, while the poseur tables start at 800x800x1040 and scale up to 1800x800x1040. All designs in the Betibo family include Oak Stained, Black Stained and Dark Walnut leg options. Tabletops come either with a radius or square corner, and our standard MFC or a laminate finish.

Available Frame Colours

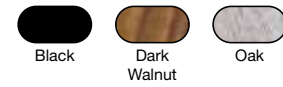

Corner Options

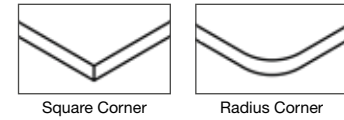

Code	Description	Corner Style	Dimensions	Height	Format	Price
BED008RS	Betibo Barrier Dining Table	Square	800 x 800	730	Square	£687
BED008RR	Betibo Barrier Dining Table	Radius	800 x 800	730	Square	£750
BED012RS	Betibo Barrier Dining Table	Square	1200 x 800	730	Rectangular	£739
BED012RR	Betibo Barrier Dining Table	Radius	1200 x 800	730	Rectangular	£804
BED016RS	Betibo Barrier Dining Table	Square	1600 x 800	730	Rectangular	£791
BED016RR	Betibo Barrier Dining Table	Radius	1600 x 800	730	Rectangular	£851
BED018RS	Betibo Barrier Dining Table	Square	1800 x 800	730	Rectangular	£821
BED018RR	Betibo Barrier Dining Table	Radius	1800 x 800	730	Rectangular	£884
BEP008RS	Betibo Barrier Poseur Table	Square	800 x 800	1040	Square	£1,028
BEP008RR	Betibo Barrier Poseur Table	Radius	800 x 800	1040	Square	£1,092
BEP018RS	Betibo Barrier Poseur Table	Square	1800 x 800	1040	Rectangular	£1,188
BEP018RR	Betibo Barrier Poseur Table	Radius	1800 x 800	1040	Rectangular	£1,252



GD1 POSEUR TABLES

10 Year
Guarantee

This striking family of tables brings both sophistication and functionality to breakout spaces, agile working areas or places where you simply want to connect for those 'away-from-desk' activities. Available in two height variations and a selection of footprints and finishes, GD1 is at home in any working landscape. The elegantly angled legs are produced in solid wood with an option for cleverly concealed cable control. Worksurfaces have softened corners and can feature integrated modules that bring all necessary services to each user.

Leg Options



Additional Information

Available in a variety of finishes including non-standard MFC and laminate. For alternative finishes or service modular options please contact our sales team.

Key	
'Powered'	Refers to tables with integral cable management within two legs, cable covers to the underside and fitted with 2No Back-Flip through desk modules, each with 2 UK power and single USB-A fast charge sockets.
'Cable Managed'	Refers to tables with integral cable management within two legs.
'Non-powered'	Refers to tables without cable management or service modules.

Code	Description	W	D	H	Group Z 25mm MFC	Group B 36mm MFC	Group C 25mm Lam Kiko	Group G 36mm Lam Kiko
Rectangular Poseur Height								
Leg colours available in Natural Ash and Black.								
GD1A2	Non-powered	2000	1000	1040	£2,846	£3,048	£3,197	£3,311
GD1A4	Powered	2000	1000	1040	£3,898	£4,099	£4,247	£4,340
GD1B2	Non-powered	2400	1200	1040	£2,871	£3,071	£3,221	£3,334
GD1B4	Powered	2400	1200	1040	£3,916	£4,117	£4,266	£4,361
GD1C2	Non-powered	2800	1200	1040	£3,400	£3,601	£3,751	£3,877
GD1C4	Powered	2800	1200	1040	£5,315	£5,517	£5,667	£5,793
GD1D2	Non-powered	1600	1600	1040	£2,547	£2,697	N/A	N/A
GD1D4	Cable Managed	1600	1600	1040	£3,044	£3,182	N/A	N/A
GD1E2	Non-powered	1200	1200	1040	£2,356	£2,435	£2,549	£2,612
GD1E4	Cable Managed	1200	1200	1040	£2,842	£2,920	£3,035	£3,096
GD1F2	Non-powered	1000	1000	1040	£2,334	£2,394	£2,461	£2,508
GD1F4	Cable Managed	1000	1000	1040	£2,819	£2,879	£2,948	£2,993

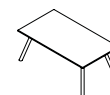

GD1 Poseur

This striking family of tables brings both sophistication and functionality to breakout spaces, agile working areas or places where you simply want to connect for those 'away-from-desk' activities. Available in two height variations and a selection of footprints and finishes, GD1 is at home in any working landscape. The elegantly angled legs are produced in solid wood with an option for cleverly concealed cable control. Worksurfaces have softened corners and can feature integrated modules that bring all necessary services to each user.

Leg Options



Additional Information

Available in a variety of finishes including non-standard MFC and laminate. For alternative finishes or service modular options please contact our sales team.

Key

'Powered'

Refers to tables with integral cable management within two legs, cable covers to the underside and fitted with 2No Back-Flip through desk modules, each with 2 UK power and single USB-A fast charge sockets.

'Cable Managed'

Refers to tables with integral cable management within two legs.

'Non-powered'

Refers to tables without cable management or service modules.

Code	Description	W	D	H	Group Z 25mm MFC	Group B 36mm MFC	Group C 25mm Lam Kiko	Group G 36mm Lam Kiko
Rectangular Dining Height								
Leg colours available in Natural Ash and Black.								
GD1A1	Non-powered	2000	1000	740	£2,709	£2,909	£3,059	£3,173
GD1A3	Powered	2000	1000	740	£3,773	£3,975	£4,122	£4,215
GD1B1	Non-powered	2400	1200	740	£2,782	£2,982	£3,133	£3,245
GD1B3	Powered	2400	1200	740	£3,791	£3,993	£4,143	£4,234
GD1C1	Non-powered	2800	1200	740	£3,246	£3,446	£3,595	£3,721
GD1C3	Powered	2800	1200	740	£5,145	£5,346	£5,496	£5,620
GD1D1	Non-powered	1600	1600	740	£2,391	£2,529	N/A	N/A
GD1D3	Cable Managed	1600	1600	740	£2,891	£3,029	N/A	N/A
GD1E1	Non-powered	1200	1200	740	£2,190	£2,267	£2,383	£2,445
GD1E3	Cable Managed	1200	1200	740	£2,689	£2,768	£2,880	£2,944
GD1F1	Non-powered	1000	1000	740	£2,167	£2,227	£2,294	£2,340
GD1F3	Cable Managed	1000	1000	740	£2,669	£2,727	£2,794	£2,840

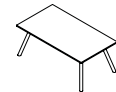

GD1 Dining

GD10 DINING TABLES

10 Year Guarantee

Form beautifully meets function in the GD10 wooden dining table. The wide table top is supported by sturdy leg posts, and the piece is available in a range of dimensions to accommodate your needs comfortably, with plenty of room for all. The GD10's chic silhouette is well-suited for employee lounges, meeting rooms or collaborative workspaces and can be fitted with shelving, storage, cable management, service modules, lighting and power solutions.

Wood Colour



Oak Block

Oak Top

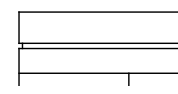

Lam/Lino Top



Additional Information

Bespoke sizes available on request. Cut out slots can be added on request. It is recommended that Pure Tung Oil be applied every 6 to 9 months. Contact our Sales Department for further information.

Tables

Code	Description	W	D	Option Cable Basket	Oak	25mm Lam Halo	25mm Lino Forbo
751mm High							
GD10A1	Four Leg	1600 x 900		MECT16	£3,067	£3,067	£3,374
GD10A2	Four Leg	1800 x 900		MECT18	£3,103	£3,103	£3,412
GD10A3	Four Leg	2000 x 900		MECT20	£3,138	£3,138	£3,451
GD10A4	Four Leg	2200 x 900		MECT20	£3,173	£3,173	£3,489
GD10A5	Four Leg	2400 x 900		MECT12 (x2)	£3,207	£3,207	£3,527
GD10B1	Four Leg	1600 x 1200		MECT16D	£3,954	£3,954	£4,348
GD10B2	Four Leg	1800 x 1200		MECT18D	£3,987	£3,987	£4,387
GD10B3	Four Leg	2000 x 1200		MECT20D	£4,022	£4,022	£4,427
GD10B4	Four Leg	2200 x 1200		MECT20D	£4,059	£4,059	£4,464
GD10B5	Four Leg	2400 x 1200		MECT12D (x2)	£4,094	£4,094	£4,503
GD10E1	Six Leg	3000 x 900		MECT14 (x2)	£5,259	£5,259	£5,784
GD10E2	Six Leg	4000 x 900		MECT20 (x2)	£5,955	£5,955	£6,549
GD10F1	Six Leg	3000 x 1200		MECT14D (x2)	£5,898	£5,898	£6,488
GD10F2	Six Leg	4000 x 1200		MECT20D (x2)	£7,795	£7,795	£8,574



Please note, prices are retail and include delivery. Installation is 5% of the nett value, with a minimum value of £417 nett. During normal working hours, Mondays to Fridays. Tables are supplied in packs for assembly on site. Access should be checked and confirmed. Top packs are supplied in one piece. To aid access, these can be supplied in shorter sections with split joints. **Surcharge per table: £555**



GD10 Table with Vapour Linoleum Top

The GD10 poseur table sits slightly higher than a typical wooden dining table, offering a modern alternative to conventional lounge or collaborative seating. The piece offers a generous table top and is available in a range of dimensions, suitable for your space and needs. The GD10 poseur table can be enhanced with a number of optional features to improve productivity, including lighting and power, storage, shelving, cable organisation and service module solutions.

Wood Colour



Oak Block

Oak Top



Lam/Lino Top

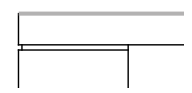

Additional Information

Bespoke sizes available on request. Cut out slots can be added on request. It is recommended that Pure Tung Oil be applied every 6 to 9 months. Contact our Sales Department for further information.

Code	Description	W	D	Option Cable Basket	Oak	25mm Lam Halo	25mm Lino Forbo
1071mm High							
GD10C1	Four Leg	1600 x 900		MECT16	£3,784	£3,784	£4,163
GD10C2	Four Leg	1800 x 900		MECT18	£3,818	£3,818	£4,201
GD10C3	Four Leg	2000 x 900		MECT20	£3,853	£3,853	£4,238
GD10C4	Four Leg	2200 x 900		MECT20	£3,887	£3,887	£4,278
GD10C5	Four Leg	2400 x 900		MECT12 (x2)	£3,923	£3,923	£4,314
GD10D1	Four Leg	1600 x 1200		MECT16D	£4,662	£4,662	£5,129
GD10D2	Four Leg	1800 x 1200		MECT18D	£4,696	£4,696	£5,167
GD10D3	Four Leg	2000 x 1200		MECT20D	£4,733	£4,733	£5,203
GD10D4	Four Leg	2200 x 1200		MECT20D	£4,766	£4,766	£5,243
GD10D5	Four Leg	2400 x 1200		MECT12D (x2)	£4,801	£4,801	£5,282
GD10G1	Six Leg	3000 x 900		MECT14 (x2)	£5,607	£5,607	£6,167
GD10G2	Six Leg	4000 x 900		MECT20 (x2)	£6,301	£6,301	£6,933
GD10H1	Six Leg	3000 x 1200		MECT14D (x2)	£6,177	£6,177	£6,793
GD10H2	Six Leg	4000 x 1200		MECT20D (x2)	£8,107	£8,107	£8,917



Please note, prices are retail and include delivery. Installation is 5% of the nett value, with a minimum value of £417 nett. During normal working hours, Mondays to Fridays. Tables are supplied in packs for assembly on site. Access should be checked and confirmed. Top packs are supplied in one piece. To aid access, these can be supplied in shorter sections with split joints. **Surcharge per table: £555**



GD10C5

GD10 DINING LED TABLES

10 Year Guarantee

The GD10 with LED Light Bar offers a contemporary flourish to conventional lounge or collaborative seating. The piece offers a generous table top and is available in a range of dimensions, with an aluminium cased LED strip light fitted through the table top suitable for day and night-time use.

Wood Colour



Oak Block

Oak Top

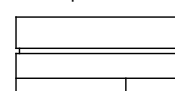

Lam/Lino Top

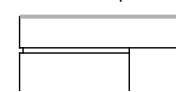

Additional Information

Anodised aluminium light encased in solid engineered hardwood frame, with Polycarbonate diffuser & on/off switch. LED lit 100mm in from each leg - 4000K colour temp. Supplied with 3 metre cable.

Tables

Code	Description	W	D	Option Cable Basket	Oak	25mm Lam Halo	25mm Lino Forbo
751mm High with 430mm High LED Light Bar							
GD10A1L	Four Leg	1600 x 900		MECT16	£4,821	£4,821	£5,304
GD10A2L	Four Leg	1800 x 900		MECT18	£4,983	£4,983	£5,484
GD10A3L	Four Leg	2000 x 900		MECT20	£5,263	£5,263	£5,791
GD10A4L	Four Leg	2200 x 900		MECT20	£5,429	£5,429	£5,974
GD10A5L	Four Leg	2400 x 900		MECT12 (x2)	£5,560	£5,560	£6,116
GD10B1L	Four Leg	1600 x 1200		MECT16D	£5,707	£5,707	£6,280
GD10B2L	Four Leg	1800 x 1200		MECT18D	£5,870	£5,870	£6,457
GD10B3L	Four Leg	2000 x 1200		MECT20D	£6,150	£6,150	£6,763
GD10B4L	Four Leg	2200 x 1200		MECT20D	£6,315	£6,315	£6,948
GD10B5L	Four Leg	2400 x 1200		MECT12D (x2)	£6,446	£6,446	£7,091
GD10E1L	Six Leg	3000 x 900		MECT14 (x2)	£8,015	£8,015	£8,816
GD10E2L	Six Leg	4000 x 900		MECT20 (x2)	£9,980	£9,980	£10,978
GD10F1L	Six Leg	3000 x 1200		MECT14D (x2)	£8,419	£8,419	£9,263
GD10F2L	Six Leg	4000 x 1200		MECT20D (x2)	£11,820	£11,820	£13,003

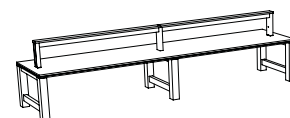
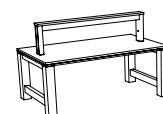

Please note, prices are retail and include delivery. Installation is 5% of the nett value, with a minimum value of £417 nett. During normal working hours, Mondays to Fridays. Tables are supplied in packs for assembly on site. Access should be checked and confirmed. Top packs are supplied in one piece. To aid access, these can be supplied in shorter sections with split joints. **Surcharge per table: £555**



GD10 POSEUR LED TABLES

LEDs are extremely energy efficient and consume up to 90% less power than incandescent bulbs. Since LEDs use only a fraction of the energy of an incandescent light bulb there is a dramatic decrease in power costs, therefore, for creating an eco environment in a grand office space, the GD10 with LED would be perfect for reducing your impact on the environment.

Wood Colour



Oak Block

Oak Top



Lam/Lino Top



Additional Information

Anodised aluminium light encased in solid engineered hardwood frame, with Polycarbonate diffuser & on/off switch. LED lit 100mm in from each leg - 4000K colour temp. Supplied with 3 metre cable.

Code	Description	W	D	Option Cable Basket	Oak	25mm Lam Halo	25mm Lino Forbo
1071mm High with 430mm High LED Light Bar							
GD10C1L	Four Leg	1600 x 900		MECT16	£5,537	£5,537	£6,092
GD10C2L	Four Leg	1800 x 900		MECT18	£5,701	£5,701	£6,270
GD10C3L	Four Leg	2000 x 900		MECT20	£5,981	£5,981	£6,578
GD10C4L	Four Leg	2200 x 900		MECT20	£6,147	£6,147	£6,760
GD10C5L	Four Leg	2400 x 900		MECT12 (x2)	£6,274	£6,274	£6,904
GD10D1L	Four Leg	1600 x 1200		MECT16D	£6,416	£6,416	£7,059
GD10D2L	Four Leg	1800 x 1200		MECT18D	£6,578	£6,578	£7,235
GD10D3L	Four Leg	2000 x 1200		MECT20D	£6,858	£6,858	£7,545
GD10D4L	Four Leg	2200 x 1200		MECT20D	£7,023	£7,023	£7,725
GD10D5L	Four Leg	2400 x 1200		MECT12D (x2)	£7,153	£7,153	£7,869
GD10G1L	Six Leg	3000 x 900		MECT14 (x2)	£8,363	£8,363	£9,200
GD10G2L	Six Leg	4000 x 900		MECT20 (x2)	£10,328	£10,328	£11,359
GD10H1L	Six Leg	3000 x 1200		MECT14D (x2)	£8,698	£8,698	£9,568
GD10H2L	Six Leg	4000 x 1200		MECT20D (x2)	£12,133	£12,133	£13,347

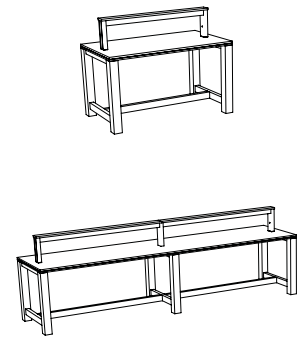

Please note, prices are retail and include delivery. Installation is 5% of the nett value, with a minimum value of £417 nett. During normal working hours, Mondays to Fridays. Tables are supplied in packs for assembly on site. Access should be checked and confirmed. Top packs are supplied in one piece. To aid access, these can be supplied in shorter sections with split joints. **Surcharge per table: £555**



GD10C5L





GD10 BENCH SEATING TABLES



Complement the GD10 wooden dining table with chic and sturdy bench seating. Designed to match the silhouette of the table range, it will blend seamlessly into a modern workplace. Available in a range of lengths to accommodate your chosen table and a choice of original Oak block top or a coloured Halo Laminate top to answer to key interior trends.

Wood Colour



Oak Block

Oak Seat

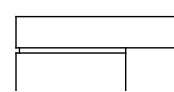

Lam Seat



Additional Information

Bespoke sizes available on request. It is recommended that Pure Tung Oil be applied every 6 to 9 months. Contact our Sales Department for further information.

Tables

Code	Description	W	D	Oak	25mm Lam Halo
450mm High Bench Seat					
GD1005BS	Four Leg	500	x 350	£456	£456
GD1006BS	Four Leg	600	x 350	£489	£489
GD1008BS	Four Leg	800	x 350	£529	£529
GD1010BS	Four Leg	1000	x 350	£592	£592
GD1012BS	Four Leg	1200	x 350	£617	£617
GD1014BS	Six Leg	1400	x 350	£789	£789
GD1016BS	Six Leg	1600	x 350	£814	£814
GD1018BS	Six Leg	1800	x 350	£835	£835
GD1020BS	Six Leg	2000	x 350	£866	£866
GD1022BS	Six Leg	2200	x 350	£893	£893
GD1024BS	Six Leg	2400	x 350	£915	£915



GD10 Bench Seating



GD10 Dining

GD10 CABLE MANAGEMENT TABLES

10 Year Guarantee



Tables

Cable Baskets

Code	Basket Length	Type	Price
Single Sided			
MECT20	1832	20	£88
MECT18	1629	18	£86
MECT16	1426	16	£82
MECT14	1222	14	£81
MECT12	1019	12	£76
MECT10	816	10	£73



Cable Baskets

Code	Basket Length	Type	Price
Double Sided			
MECT20D	1832	20D	£132
MECT18D	1629	18D	£128
MECT16D	1426	16D	£122
MECT14D	1222	14D	£121
MECT12D	1019	12D	£114
MECT10D	816	10D	£109

Optional Worksurface Cut-Outs

When specifying cut-outs, suffix the table code with one of the below.
 Example of code - GD10A1C6

Code	Dimensions	Price	Diagram
P	Ø80mm Allows for UK 3 Pin plug and additional accessories	£68	
C4	Ø60mm Allows for UK 3 Pin plug	£68	
C5	400mm x 200mm Slot (Please specify position required)	£68	
C6	500mm x 60/20mm 'Dog-Bone' Slot (Please specify position required)	£68	



Cable Spine

Code	Description	Price
GCR12B	1250mm - Black (42 Sections)	£109
GCR12W	1250mm - White (42 Sections)	£109





GD10 CIRQUE TABLES

Capturing the trend for curved edges and circularity is our new GD10 Cirque table collection. Available in four sizes, and one functional height, the contemporary design highlights the beauty of natural wood with a stunning oak top. Additionally, several productivity features can be installed including lighting, power and cable organisation. Whether used to encourage collaboration work, support socialising or facilitate meetings, the GD10 Cirque has been built with the needs of modern spaces in mind.

Wood



GDQUE12
Small Table - 1200Ø



GDQUE14
Medium Table - 1400Ø



GDQUE16
Large Table - 1600Ø



GDQUE18
Extra Large Table - 1800Ø

Code	Description	Dimensions	Height	Leg Space	Price
GDQUE12	GD10 Cirque Table Small	1200Ø	751	550	£3,252
GDQUE14	GD10 Cirque Table Medium	1400Ø	751	550	£3,362
GDQUE16	GD10 Cirque Table Large	1600Ø	751	800	£4,245
GDQUE18	GD10 Cirque Table Extra Large	1800Ø	751	800	£4,386



Tables

STEPS TABLES



The Steps table is part of an award winning family. It pairs seamlessly with the lounge and compact Steps chairs to create a distinct and effortless elegance.



Tables

Code	Description	W	D	H	Group Z 25mm MFC	Group C 25mm Lam Kiko	Group D 25mm CH Lam Kiko	
Steel Frame								
Steel Frames can accept wood cladding - surcharge: £483								
STT49C	Circular		Ø900	x 400	£587	£624	£674	○
STT59C	Circular		Ø900	x 575	£592	£629	£677	
STT49S	Square	900	x 900	x 400	£591	£626	£676	□
STT59S	Square	900	x 900	x 575	£593	£630	£679	
STT49E	Elliptical	1400	x 900	x 400	£750	£784	£835	⬭
STT59E	Elliptical	1400	x 900	x 575	£753	£790	£838	



Steps Steel Frame

10 Year
Guarantee

STEPS TABLES

The Steps table is part of an award winning family. It pairs seamlessly with the lounge and compact Steps chairs to create a distinct and effortless elegance.



Code	Description	W	D	H	Group Z 25mm MFC	Group C 25mm Lam Kiko	Group D 25mm CH Lam Kiko	
Aluminium Frame								
STT49CA	Circular		Ø900	x 400	£587	£624	£674	○
STT59CA	Circular		Ø900	x 575	£592	£629	£677	
STT49SA	Square	900	x 900	x 400	£591	£626	£676	□
STT59SA	Square	900	x 900	x 575	£593	£630	£679	
STT49EA	Elliptical	1400	x 900	x 400	£750	£784	£835	⬭
STT59EA	Elliptical	1400	x 900	x 575	£753	£790	£838	

Tables



Steps Aluminium Frame

LS21 TABLES

10 Year
Guarantee

As part of our ever-growing portfolio of Lifestyle products, the LS21 family of tables has been introduced to co-ordinate with a selection of lounge, pyramid-based seating; making those 'away-from-desk' areas more cohesive.



Tables

Code	Top Shape	Dimensions	Group Z 25mm MFC	Group B 36mm MFC	Group C 25mm Lam Kiko	Group D 25mm CH Lam Kiko
Coffee - 455mm High						
LS21A1	Circular	Ø700	£322	£515	£670	£747
LS21A2	Circular	Ø800	£335	£531	£690	£763
LS21B1	Square	600 x 600	£297	£491	£638	£714
LS21B2	Square	700 x 700	£311	£505	£658	£732
Lounge - 575mm High						
LS21C1	Circular	Ø700	£328	£522	£676	£753
LS21C2	Circular	Ø800	£342	£536	£696	£770
LS21D1	Square	600 x 600	£304	£498	£645	£721
LS21D2	Square	700 x 700	£319	£510	£664	£738



As part of our ever-growing portfolio of Lifestyle products, the LS22 family of tables has been introduced to co-ordinate with a selection of lounge, 4 star-based seating ranges.



Code	Top Shape	Dimensions	Group Z 25mm MFC	Group B 36mm MFC	Group C 25mm Lam Kiko	Group D 25mm CH Lam Kiko
Coffee - 455mm High						
LS22A1	Circular	Ø700	£300	£494	£641	£719
LS22A2	Circular	Ø800	£314	£507	£661	£735
LS22B1	Square	600 x 600	£275	£469	£610	£688
LS22B2	Square	700 x 700	£289	£483	£630	£703
Lounge - 575mm High						
LS22C1	Circular	Ø700	£306	£502	£649	£725
LS22C2	Circular	Ø800	£322	£515	£668	£743
LS22D1	Square	600 x 600	£284	£475	£617	£693
LS22D2	Square	700 x 700	£297	£491	£637	£713

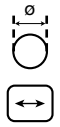

LS23 TABLES



As part of our ever-growing portfolio of Lifestyle products, the LS23 family of tables has been introduced to co-ordinate with a selection of lounge, sled-framed seating ranges.



Tables

Code	Top Shape	Dimensions	Group Z 25mm MFC	Group B 36mm MFC	Group C 25mm Lam Kiko	Group D 25mm CH Lam Kiko	
Coffee - 455mm High							
LS23A1	Circular	Ø700	£275	£455	£584	£654	
LS23A2	Circular	Ø800	£288	£468	£601	£672	
LS23A3	Circular	Ø900	£302	£480	£618	£688	
LS23B1	Square	600 x 600	£249	£431	£561	£629	
LS23B2	Square	700 x 700	£264	£442	£578	£646	
LS23B3	Square	800 x 800	£277	£458	£594	£666	
LS23C1	Rectangular	1000 x 600	£281	£461	£600	£670	
LS23C2	Rectangular	1200 x 600	£295	£473	£617	£687	
LS23C3	Rectangular	1400 x 600	£307	£489	£637	£704	
Lounge - 575mm High							
LS23D1	Circular	Ø700	£281	£461	£591	£661	
LS23D2	Circular	Ø800	£295	£473	£609	£677	
LS23D3	Circular	Ø900	£307	£489	£625	£697	
LS23E1	Square	600 x 600	£258	£437	£566	£638	
LS23E2	Square	700 x 700	£270	£449	£584	£654	
LS23E3	Square	800 x 800	£284	£464	£601	£672	
LS23F1	Rectangular	1000 x 600	£288	£468	£608	£676	
LS23F2	Rectangular	1200 x 600	£302	£480	£624	£696	
LS23F3	Rectangular	1400 x 600	£315	£494	£642	£712	



LS23

10 Year
Guarantee

LS23 TABLES

Tables



LS23

MOMENT WOODEN LEG TABLES

10 Year Guarantee

- Elegant Table system designed with legs positioned to enable users to sit at all sides.
- Available in a variety of sizes and footprints.

Wooden Leg Finishes



Tables

Code	Dimensions	Optional Cable Basket	Group Z 25mm MFC	Group B 36mm MFC	Group C 25mm Lam Kiko	Group D 25mm CH Lam Kiko
Rectangular						
MWTR2410	2400 x 1000	MECT18D	£1,203	£1,403	£1,554	£1,631
MWTR2210	2200 x 1000	MECT16D	£1,190	£1,391	£1,541	£1,619
MWTR2010	2000 x 1000	MECT14D	£1,180	£1,381	£1,529	£1,604
MWTR1810	1800 x 1000	MECT12D	£1,170	£1,371	£1,522	£1,594
MWTR1610	1600 x 1000	MECT10D	£1,160	£1,362	£1,511	£1,588
MWTR1410	1400 x 1000	MECT08D	£1,156	£1,355	£1,503	£1,584
MWTR2408	2400 x 800	MECT18D	£1,152	£1,352	£1,502	£1,580
MWTR2208	2200 x 800	MECT16D	£1,141	£1,341	£1,491	£1,566
MWTR2008	2000 x 800	MECT14D	£1,128	£1,330	£1,478	£1,555
MWTR1808	1800 x 800	MECT12D	£1,116	£1,317	£1,468	£1,543
MWTR1608	1600 x 800	MECT10D	£1,106	£1,305	£1,454	£1,531
MWTR1408	1400 x 800	MECT08D	£1,095	£1,298	£1,446	£1,525
MWTR1208	1200 x 800	MECT06D	£1,087	£1,288	£1,438	£1,516
Square						
MWTR1616	1600 x 1600	MECT10D	£1,244	£1,446	N/A	N/A
MWTR1414	1400 x 1400	MECT08D	£1,159	£1,361	N/A	N/A
MWTR1212	1200 x 1200	MECT06D	£1,073	£1,272	£1,422	£1,497
MWTR1010	1000 x 1000	MECT04D	£1,055	£1,255	£1,403	£1,483
Circular						
MWTC16	ø1600	MECT04D	£1,149	£1,348	N/A	N/A
MWTC14	ø1400	MECT04D	£1,102	£1,302	N/A	N/A
MWTC12	ø1200	MECT04D	£1,055	£1,255	£1,403	£1,483
MWTC10	ø1000	MECT04D	£1,031	£1,232	£1,382	£1,457
Boat shaped						
MWTB24	2400 x 1000/800	MECT18D	£1,294	£1,494	£1,645	£1,722
MWTB22	2200 x 1000/800	MECT16D	£1,281	£1,483	£1,631	£1,706
MWTB20	2000 x 1000/800	MECT14D	£1,268	£1,469	£1,618	£1,693
MWTB18	1800 x 1000/800	MECT12D	£1,257	£1,457	£1,605	£1,686
MWTB16	1600 x 1000/800	MECT10D	£1,245	£1,447	£1,594	£1,675
Lozenge shaped						
MWTL24	2400 x 1000/800	MECT14D	£1,294	£1,494	£1,645	£1,722
MWTL22	2200 x 1000/800	MECT16D	£1,281	£1,483	£1,631	£1,706
MWTL20	2000 x 1000/800	MECT12D	£1,268	£1,469	£1,618	£1,693

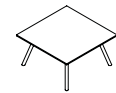
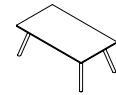

10 Year
Guarantee

MOMENT WOODEN LEG TABLES

Tables



Boat Shaped Wooden Leg Table

MOMENT STEEL LEG TABLES

10 Year Guarantee

- Clean-lined aesthetics with ease of use in mind.
- Available in a variety of sizes and footprints.



Tables

Code	Dimensions	Optional Cable Basket	Group Z 25mm MFC	Group B 36mm MFC	Group C 25mm Lam Kiko	Group D 25mm CH Lam Kiko
Rectangular						
MSTR2410	2400 x 1000	MECT18D	£855	£1,044	£1,188	£1,264
MSTR2210	2200 x 1000	MECT16D	£843	£1,035	£1,176	£1,250
MSTR2010	2000 x 1000	MECT14D	£831	£1,025	£1,166	£1,239
MSTR1810	1800 x 1000	MECT12D	£822	£1,013	£1,158	£1,228
MSTR1610	1600 x 1000	MECT10D	£815	£1,006	£1,147	£1,221
MSTR1410	1400 x 1000	MECT08D	£809	£999	£1,142	£1,214
MSTR2408	2400 x 800	MECT18D	£807	£998	£1,141	£1,213
MSTR2208	2200 x 800	MECT16D	£795	£987	£1,130	£1,203
MSTR2008	2000 x 800	MECT14D	£784	£976	£1,116	£1,189
MSTR1808	1800 x 800	MECT12D	£770	£962	£1,105	£1,177
MSTR1608	1600 x 800	MECT10D	£762	£953	£1,095	£1,168
MSTR1408	1400 x 800	MECT08D	£752	£944	£1,086	£1,161
MSTR1208	1200 x 800	MECT06D	£746	£937	£1,079	£1,150
Square						
MSTR1616	1600 x 1600	MECT10D	£893	£1,086	N/A	N/A
MSTR1414	1400 x 1400	MECT08D	£814	£1,005	N/A	N/A
MSTR1212	1200 x 1200	MECT06D	£728	£920	£1,064	£1,135
MSTR1010	1000 x 1000	MECT04D	£715	£906	£1,044	£1,118
Circular						
MSTC16	ø1600	MECT04D	£801	£996	N/A	N/A
MSTC14	ø1400	MECT04D	£760	£950	N/A	N/A
MSTC12	ø1200	MECT04D	£715	£906	£1,044	£1,118
MSTC10	ø1000	MECT04D	£692	£883	£1,026	£1,098
Boat shaped						
MSTB24	2400 x 1000/800	MECT18D	£941	£1,133	£1,274	£1,348
MSTB22	2200 x 1000/800	MECT16D	£929	£1,118	£1,264	£1,334
MSTB20	2000 x 1000/800	MECT14D	£915	£1,106	£1,249	£1,323
MSTB18	1800 x 1000/800	MECT12D	£907	£1,098	£1,240	£1,314
MSTB16	1600 x 1000/800	MECT10D	£895	£1,088	£1,228	£1,303
Lozenge shaped						
MSTL24	2400 x 1000/800	MECT16D	£941	£1,133	£1,274	£1,348
MSTL22	2200 x 1000/800	MECT14D	£929	£1,118	£1,264	£1,334
MSTL20	2000 x 1000/800	MECT12D	£915	£1,106	£1,249	£1,323

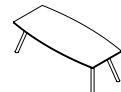
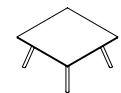
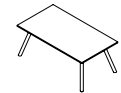

10 Year
Guarantee

MOMENT STEEL LEG TABLES

Tables



Rectangular and Circular Steel Leg Tables

MOMENT LARGE FORMAT TABLES



Large Format Tables - Starter & Add-on Units

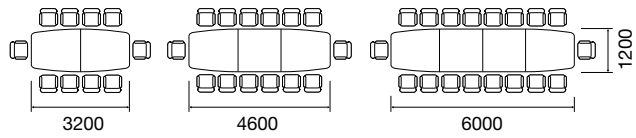

Setup Example

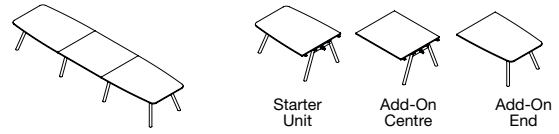

Tables



Code	Dimensions	Optional Cable Basket	Group Z 25mm MFC	Group B 36mm MFC	Group C 25mm Lam Kiko	Group D 25mm CH Lam Kiko	
Starter Unit							
MWBET16	1600 x 1200/800 Wood Leg	MECT12D	£1,051	£1,251	£1,400	£1,477	↔
MSBET16	1600 x 1200/800 Steel Leg	MECT12D	£709	£899	£1,041	£1,115	
Add-On End							
MWBET16A	1600 x 1200/800 Wood Leg	MECT12D	£707	£910	£1,057	£1,135	↔
MSBET16A	1600 x 1200/800 Steel Leg	MECT12D	£529	£721	£861	£935	
Add-On Centre							
MWCT14A	1400 x 1200 Wood Leg	MECT14D	£707	£910	£1,057	£1,135	↔
MSCT14A	1400 x 1200 Steel Leg	MECT14D	£529	£721	£861	£935	

C4 Planter Box
C5 Access Flap



£86 Surcharge
£288 Surcharge

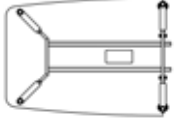

Optional Cut Out Specification

<p>Rectangular, Boat Shaped and Lozenge 1000w not available with C1 Cut Out C4 Cut Outs are only available on Rectangular tables 1400w and over. C5 Cut Outs are only available on Rectangular tables 1600w and over</p> 	<p>Boardroom Starter Boardroom End</p> 
<p>Circular C2 and C3 Cut Outs only available on 1400ø and 1600ø C1, C4 and C5 Cut Outs are not available on Circular tables.</p> <p>Square 1000w and 800w not available with C1 Cut Out. C4 and C5 Cut Outs are only available on 1600w Square tables. C2 and C3 Cut Outs not available on 800w tables.</p> 	<p>Boardroom Centre</p> 

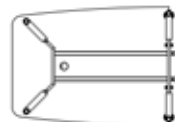
Optional Cable Port Specification

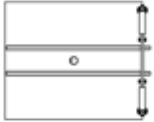
<p>Rectangular, Boat Shaped and Lozenge</p> 	<p>Boardroom Starter Boardroom End</p> 
<p>Circular and Square</p> 	<p>Boardroom Centre</p> 

Cable Baskets

MECT20D	2000	1832	336	£132
MECT18D	1800	1629	336	£128
MECT16D	1600	1426	336	£122
MECT14D	1400	1222	336	£121
MECT12D	1200	1019	336	£114
MECT10D	1000	816	336	£109
MECT08D	800	612	336	£107
MECT06D	600	410	336	£105
MECT04D	400	210	336	£103

Cable Spine

ø60 x 700h

Code	Colour	Price
BCRB	Black	£82
BCRS	Silver	£82
BCRW	White	£82



DECK INTRODUCTION TABLES



Introducing Deck, a timeless bench table and seating collection that boasts effortless sophistication and stylish simplicity. With its crisp, clean lines and distinctive finishes, the Deck collections' versatility can perfectly fulfil modern workplace requirements.

The Deck collection is an ideal choice for office and leisure environments - whether used for hot-desking, corporate meetings or communal dining. Its flexibility facilitates individual work and collaborative discussions, while making it even easier for employees and executives alike to move seamlessly from one activity or project to another. The Deck collection saves time and space when both are limited - it is the obvious choice for any working environment.

This refined collection can be extensively customised to fulfil the needs of your space and it is available in a range of specifications. These include options for sitting or standing height models, various end frame materials and customisable unit dimensions. The Deck collection makes use of your entire landscape and can be offered in an almost limitless combination of surface finishes. In fact, each bench or table unit can be created to your preferences or made to satisfy unique corporate requirements.

Whether you'd like a classic wood effect, vibrant block colours or funky patterns this family of furniture will help you to make a statement and enhance every inch of your space.



Single Laminate
Single colour with matching or contrasting edge - SUFFIX 'S'



Dual Laminate
Two colour with matching or contrasting edge - SUFFIX 'D'

MFC Finishes -

- Available in single colour MFC Finishes - Both styles of panel ended products are produced flat-packed and assembled on site.
- Steel Framed products are supplied fully assembled.
- MFC Deck products have 38mm Tops & 25mm End Panels, where appropriate.
- Available with Contrasting Edge



Laminate Finishes -

- Panel Ended and Inset Panel products are produced flat-packed and assembled on site.
- Mitred Panel Ended and Steel Framed products are supplied fully assembled and we would recommend specialised handling to site. For delivery and installation details, contact our Sales Team. Laminate Deck products have 38mm Tops & End Panels, where appropriate.
- Available with Contrasting Edging.

Alternative laminates are available (Halo, Fenix, Filafo) Please refer to the Technical Data Section. Surcharges will be applicable.

All Deck Products

- Use stools from our Seating section with Poseur Height Tables.
- Small Bench Seats can nest under wider Dining Tables.
- All Deck products may require a team lift due to their heavy nature.
- Inset Panel Deck have their ends inset by 300mm.



Deck Mitred Poseur Height with Dual Laminate

Single Laminate

Panel ended and inset tables and benches of various sizes with 38mm top and panel ends with a single colour laminate finish with matching or contrasting edge. 40mm square steel four legged tables and benches of various sizes with 38mm top panels in a single laminate finish with matching or contrasting edge. Frames available in Silver, White, Black, Grey or Chrome paint.

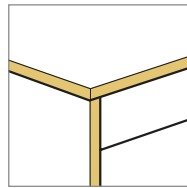

Panel Ended

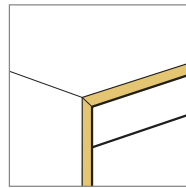

Panel Ended (Mitred)

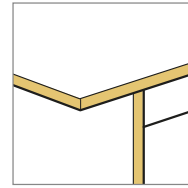

Inset Panel Ended

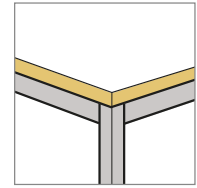

Square Steel

Dual Laminate

Panel ended and inset tables and benches of various sizes with 38mm top and panel ends in a choice of two laminate colour finishes on outside and inside faces. Matching or contrasting edge.

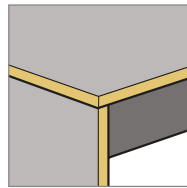

Panel Ended

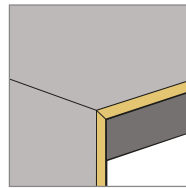

Panel Ended (Mitred)

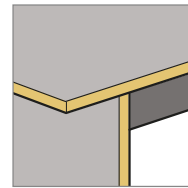

Inset Panel Ended

MFC

Panel ended and inset tables and benches of various sizes with 38mm top panels and 25mm panel ends in a choice of melamine finishes with matching or contrasting edge. 40mm square steel four legged tables and benches of various sizes with 38mm top panels in a choice of melamine finishes with matching or contrasting edge. Frames available in Silver, White, Black, Grey or Chrome paint.

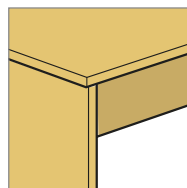

Panel Ended

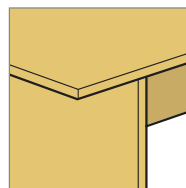

Inset Panel Ended

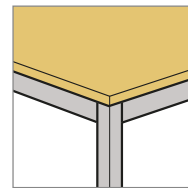

Square Steel



Deck Mitred Edge with Single Laminate

DECK MITRED TABLES

5 Year
Guarantee

Deck Mitred is the premium product within this collection. It incorporates traditional joinery skills and hand-applied finishes. Choose from an array of laminate finishes that can be uniform or specified as two-toned, single colours or patterned relief. These variations enable the model to complement its surroundings, stirring emotions and adding a sense of theatre.

Deck Laminate Surcharges

Halo Collection £199
Fenix Collection £688
Filafo Collection £3,581



Tables

Code	Dimensions	Single Laminate Price Kiko	Dual Laminate Price Kiko
Mitred Panel Ended			
Poseur 1100mm high			
DCPTRL208	2000 x 800	£2,451	£2,845
DCPTRL188	1800 x 800	£2,219	£2,612
DCPTRL168	1600 x 800	£2,067	£2,461
Dining 750mm high			
DCTRL22	2200 x 800	£2,276	£2,610
DCTRL20	2000 x 800	£2,170	£2,563
DCTRL18	1800 x 800	£2,052	£2,447
DCTRL16	1600 x 800	£1,881	£2,230
DCTRL14	1400 x 800	£1,751	£2,143
Bench Seats 450mm high			
DCBRL22	2200 x 350	£1,223	£1,444
DCBRL20	2000 x 350	£1,217	£1,202
DCBRL18	1800 x 350	£1,050	£1,268
DCBRL16	1600 x 350	£962	£1,181
DCBRL14	1400 x 350	£899	£1,118
DCBRL12	1200 x 350	£856	£1,075

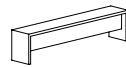
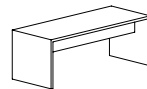
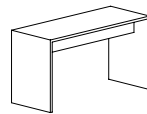

Deck Mitred Poseur Height Table with Single Laminate

DECK INSET PANEL END TABLES

We certainly believe in style and finesse, but functionality and form are also essential. Each Deck Inset model shares the same design DNA as the rest of the collection, but acknowledges the fact that there are times when users need to sit at the ends of the benches as well as at the sides. The inset panels included in these models allow for this by providing sitting or standing space at both ends of the work surface, while matching their flush panel ended counterparts in finish and style.

Deck Laminate Surcharges
 Halo Collection £199
 Fenix Collection £688
 Filalo Collection £3,581



Code	Dimensions	Single Laminate Price Kiko	Dual Laminate Price Kiko	
Inset Panel Ended				
Poseur 1100mm high				
DCPTL208	2000 x 800	£2,079	£2,413	
DCPTL188	1800 x 800	£1,881	£2,216	
DCPTL168	1600 x 800	£1,756	£2,090	
Dining 750mm high				
DCTEL22	2200 x 800	£1,931	£2,212	
DCTEL20	2000 x 800	£1,843	£2,176	
DCTEL18	1800 x 800	£1,738	£2,076	
DCTEL16	1600 x 800	£1,595	£1,892	
DCTEL14	1400 x 800	£1,485	£1,818	
Bench Seats 450mm high				
DCBEL22	2200 x 350	£1,039	£1,223	
DCBEL20	2000 x 350	£1,031	£1,144	
DCBEL18	1800 x 350	£891	£1,075	
DCBEL16	1600 x 350	£817	£1,000	
DCBEL14	1400 x 350	£763	£950	
DCBEL12	1200 x 350	£727	£913	

Code	Dimensions	MFC	
Inset Panel			
Poseur 1100mm high			
DCPTM208	2000 x 800	£1,172	
DCPTM188	1800 x 800	£1,056	
DCPTM168	1600 x 800	£984	
Dining 750mm high			
DCTEM22	2200 x 800	£1,086	
DCTEM20	2000 x 800	£1,036	
DCTEM18	1800 x 800	£978	
DCTEM16	1600 x 800	£900	
DCTEM14	1400 x 800	£838	
Bench Seats 450mm high			
DCBEM22	2200 x 350	£685	
DCBEM20	2000 x 350	£636	
DCBEM18	1800 x 350	£583	
DCBEM16	1600 x 350	£533	
DCBEM14	1400 x 350	£485	
DCBEM12	1200 x 350	£474	



Deck Inset Panel End Poseur Height Table with Single Laminate

DECK PANEL END TABLES



Panel Ended Deck differs only slightly from Deck Mitred, with the top surface being a separate piece, this allows you to specify contrasting finishes to create a two-toned look. Available in Dining height and Poseur height with matching bench seating to forge a sleek and modern dining space or a clean and simple away-from-desk area or touch down zone.

Deck Laminate Surcharges
 Halo Collection £199
 Fenix Collection £688
 Filaflo Collection £3,581



Tables

Code	Dimensions	Single Laminate Price Kiko	Dual Laminate Price Kiko
Panel Ended			
Poseur 1100mm high			
DCPTL208	2000 x 800	£2,187	£2,540
DCPTL188	1800 x 800	£1,980	£2,330
DCPTL168	1600 x 800	£1,846	£2,198

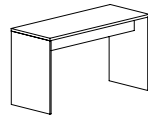

Code	Dimensions	Single Laminate Price Kiko	Dual Laminate Price Kiko
Dining 750mm high			
DCTL22	2200 x 800	£2,031	£2,328
DCTL20	2000 x 800	£1,939	£2,288
DCTL18	1800 x 800	£1,831	£2,183
DCTL16	1600 x 800	£1,678	£1,993
DCTL14	1400 x 800	£1,560	£1,915

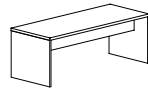

Code	Dimensions	Single Laminate Price Kiko	Dual Laminate Price Kiko
Bench Seats 450mm high			
DCBL22	2200 x 350	£1,091	£1,287
DCBL20	2000 x 350	£1,085	£1,202
DCBL18	1800 x 350	£936	£1,131
DCBL16	1600 x 350	£857	£1,054
DCBL14	1400 x 350	£800	£998
DCBL12	1200 x 350	£763	£959

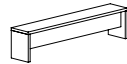

Code	Dimensions	MFC Price
Panel Ended		
Poseur 1100mm high		
DCPTM208	2000 x 800	£1,230
DCPTM188	1800 x 800	£1,113
DCPTM168	1600 x 800	£1,038

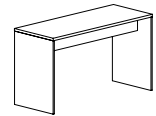

Code	Dimensions	MFC Price
Dining 750mm high		
DCTM22	2200 x 800	£1,144
DCTM20	2000 x 800	£1,087
DCTM18	1800 x 800	£1,028
DCTM16	1600 x 800	£945
DCTM14	1400 x 800	£883

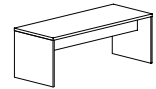

Code	Dimensions	MFC Price
Bench Seats 450mm high		
DCBM22	2200 x 350	£722
DCBM20	2000 x 350	£669
DCBM18	1800 x 350	£615
DCBM16	1600 x 350	£562
DCBM14	1400 x 350	£511
DCBM12	1200 x 350	£498

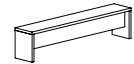

Deck Poseur Height MFC

5 Year
Guarantee

DECK STEEL TABLES

The Deck Steel model combines the features of the panel ended and inset models, by allowing users to sit all along and around the work surface, without the structure impinging on their leg space. Its lightweight yet robust frame is fully welded and offers an additional opportunity for users to introduce metallic colours into the working landscape, while remaining cohesive with adjacent furniture from different ranges. Deck Steel frames boast minimalistic style and clear air circulation within open-plan areas. Each model is available with sitting and standing height work surfaces, with matching bench seating.

Deck Laminate Surcharges
Halo Collection £170
Fenix Collection £554
Filafo Collection £2,902



Code	Dimensions	Single Laminate Price Kiko
------	------------	----------------------------

Steel Frame 40mm x 40mm square

Poseur Tables 1100mm high

DCPTSL188	1800 x 800	£1,149
DCPTSL168	1600 x 800	£1,031
DCPTSL148	1400 x 800	£935
DCPTSL186	1800 x 600	£1,128
DCPTSL166	1600 x 600	£1,012

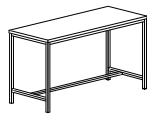

Dining Tables 750mm high

DCTSL18	1800 x 800	£1,104
DCTSL16	1600 x 800	£992
DCTSL14	1400 x 800	£892
DCTSL12	1200 x 800	£820
DCTSL10	1000 x 800	£789

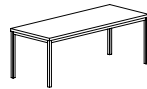

Bench Seats 450mm high

DCBSL18	1800 x 350	£758
DCBSL16	1600 x 350	£691
DCBSL14	1400 x 350	£609
DCBSL12	1200 x 350	£538
DCBSL10	1000 x 350	£511



Code	Dimensions	MFC Price
------	------------	-----------

Steel Frame 40mm x 40mm square

Poseur 1100mm high

DCPTSM188	1800 x 800	£854
DCPTSM168	1600 x 800	£763
DCPTSM148	1400 x 800	£694
DCPTSM186	1800 x 600	£831
DCPTSM166	1600 x 600	£747

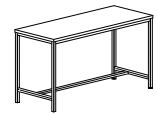

Dining 750mm high

DCTSM18	1800 x 800	£804
DCTSM16	1600 x 800	£723
DCTSM14	1400 x 800	£648
DCTSM12	1200 x 800	£595
DCTSM10	1000 x 800	£572

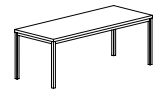

Bench Seats 450mm high

DCBSM18	1800 x 350	£550
DCBSM16	1600 x 350	£502
DCBSM14	1400 x 350	£443
DCBSM12	1200 x 350	£393
DCBSM10	1000 x 350	£373



Deck Steel Dining Height Table

DECK SEAT PADS TABLES



Enhance your relaxation by adding an upholstered seat pad to your Deck Bench Seats. With two options available, choose between a cost-effective cushioning or a maximum comfort cushioning for extended use.



Tables

Code	Dimensions	Band 1	Band 2	Band 3	Band 4	Band 5	Band 6	Band 7
Optional Upholstered Seat Pads - fit to any Deck Seats with bolt fixing kit supplied. (* Requires User Modification)								
DC22SP	2200wx 350d x 50h	£277	£332	£407	£476	£554	£625	£694
DC20SP	2000wx 350d x 50h	£266	£319	£386	£450	£522	£586	£649
DC18SP	1800wx 350d x 50h	£257	£304	£364	£423	£489	£548	£605
DC16SP	1600wx 350d x 50h	£246	£288	£343	£395	£454	£507	£560
DC14SP	1400wx 350d x 50h	£235	£274	£323	£370	£422	£469	£515
DC12SP	1200wx 350d x 50h	£226	£259	£302	£343	£388	£428	£471
DC10SP	1000wx 350d x 50h	£204	£225	£249	£273	£299	£322	£345



Code	Dimensions	Band 1	Band 2	Band 3	Band 4	Band 5	Band 6	Band 7
Optional Maximum Comfort Upholstered Seat Pads - fit to any Deck Seats with bolt fixing kit supplied. (* Requires User Modification)								
DC22SM	2200wx 350d x 65h	£290	£350	£427	£502	£583	£656	£729
DC20SM	2000wx 350d x 65h	£279	£333	£406	£473	£549	£615	£681
DC18SM	1800wx 350d x 65h	£270	£319	£384	£445	£511	£574	£635
DC16SM	1600wx 350d x 65h	£259	£304	£362	£416	£477	£533	£587
DC14SM	1400wx 350d x 65h	£247	£287	£340	£388	£443	£491	£538
DC12SM	1200wx 350d x 65h	£238	£272	£318	£361	£408	£450	£492
DC10SM	1000wx 350d x 65h	£217	£233	£261	£286	£312	£337	£362



Maximum Comfort Upholstered Seat Pad

5 Year
Guarantee

DECK SEAT PADS TABLES

Tables



Deck Panel Ended Poseur Height with Single Laminate

iMedia units are tables designed for collaborative work, presentations and informal meetings. They can be used to mount display monitors, house I.T. equipment and promote connectivity.

- Available in three footprint styles, three lengths & two heights.
- Supplied with equipment cabinets to the front and rear.
- Can support up to 42" monitors (not supplied).
- Fitted with 36mm MFC Tops.
- Available with a selection of optional fitted fascia modules, see below.



How To Specify

1. Select Base Code
2. Add suffix letter of service module if required
3. Order complete table

Example of code: IMA2210HC
(Angular Shaped Table with Type C module)

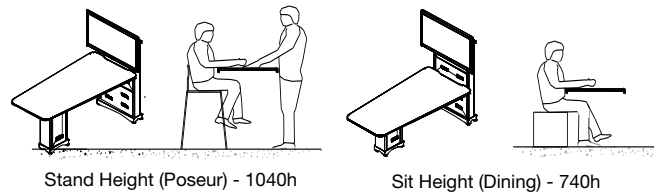

Module	Outlet Types/Quantities					
	UK POWER	CAT 6 DATA	2x USB-A FAST CHARGE	VGA & AUDIO	HDMI	SINGLE USB DATA
Type A	3	-	-	-	-	-
Type B	2	-	1	-	-	-
Type C	1	-	1	-	1	1
Type D	2	1	-	-	-	-
Type E	2	-	-	1	-	-
Type F	1	-	-	1	1	1

Optional Fascia Modules

All modules containing electrical outlets are supplied with a short lead to a male Wieland GST plug. These modules are available in Black, Silver or White and require a starter cable – sold separately. Data modules, including RJ45, HDMI & data USB are hardwired to a 3 metre lead fitted with an appropriate connector. Suffix code with relevant letter.

Stand Height Base Code	Sit Height Base Code	Dimensions	MFC Price	Type A Module Price	Type B Module Price	Type C Module Price	Type D Module Price	Type E Module Price	Type F Module Price	
Angular Shaped										
IMA2210H	IMA2210L	2200w x 1000/800d	£3,422	£3,565	£3,656	£3,781	£3,605	£3,724	£3,849	↔
IMA2010H	IMA2010L	2000w x 1000/800d	£3,408	£3,552	£3,645	£3,769	£3,589	£3,712	£3,837	
IMA1810H	IMA1810L	1800w x 1000/800d	£3,370	£3,513	£3,609	£3,731	£3,552	£3,673	£3,800	
Lozenge Shaped										
IML2210H	IML2210L	2200w x 1000/800d	£3,422	£3,565	£3,656	£3,781	£3,605	£3,724	£3,849	↔
IML2010H	IML2010L	2000w x 1000/800d	£3,408	£3,552	£3,645	£3,769	£3,589	£3,712	£3,837	
IML1810H	IML1810L	1800w x 1000/800d	£3,370	£3,513	£3,609	£3,731	£3,552	£3,673	£3,800	
Rectangular										
IMR2210H	IMR2210L	2200w x 1000d	£3,422	£3,565	£3,656	£3,781	£3,605	£3,724	£3,849	↔
IMR2010H	IMR2010L	2000w x 1000d	£3,408	£3,552	£3,645	£3,769	£3,589	£3,712	£3,837	
IMR1810H	IMR1810L	1800w x 1000d	£3,370	£3,513	£3,609	£3,731	£3,552	£3,673	£3,800	

Power Bar

Additional-Gang Socket Set - supplied with 3 metre lead to UK Plug fits within rear column.

Code	Price
IM6PM	£150





Stand Height Lozenge Shaped iMedia Table

BENCH² TABLES

10 Year
Guarantee

- Designed to work in the same environment as their desking counterpart.
- Available in a variety of sizes and footprints.
- Delivered and installed fully assembled.
- For accessories and cable management refer to Bench² Cable Trays & Accessories.



Leg styles

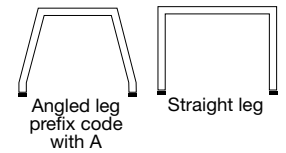

Angled leg not available on double sided add-on units.

Tables

Starter Unit Code	Dimensions	Optional Cable Tray Code	Group Z 25mm MFC	Group B 36mm MFC	Group C 25mm Lam Kiko		
Rectangular							
BFT2010	2000 x 1000	BFCT20S-I	£649	£855	£1,007		
BFT1810	1800 x 1000	BFCT18S-I	£642	£849	£1,000		
BFT1610	1600 x 1000	BFCT16S-I	£636	£838	£993		
BFT2008	2000 x 800	BFCT20S-I	£641	£846	£999		
BFT1808	1800 x 800	BFCT18S-I	£620	£825	£979		
BFT1608	1600 x 800	BFCT16S-I	£613	£819	£970		
BFT1408	1400 x 800	BFCT14S-I	£607	£809	£964		
BFT1208	1200 x 800	BFCT12S-I	£529	£731	£884		
Square							
BFT1616	1600 x 1600	BFCT16D-I	£983	£1,188	N/A		
BFT1414	1400 x 1400	BFCT14D-I	£970	£1,173	N/A		
BFT1212	1200 x 1200	BFCT12D-I	£727	£930	£1,084		
BFT1010	1000 x 1000	BFCT10S-I	£551	£755	£910		
Circular							
BFTC16	ø1600	BFCT10S-I	£649	£855	N/A		
BFTC14	ø1400	BFCT10S-I	£624	£827	N/A		
BFTC12	ø1200	BFCT08S-I	£591	£795	£948		
BFTC10	ø1000	BFCT06S-I	£545	£750	£900		
BFTC08	ø800	BFCT06S-I	£520	£725	£880		



Rectangular Starter Unit Straight Leg with Cable Ports (-P)

Add-on Unit Code	Dimensions	Optional Cable Tray Code	Group Z 25mm MFC	Group B 36mm MFC	Group C 25mm Lam
Rectangular					
Intermediate end frame not available					
BFT2010A	2000 x 1000	BFCT20S-I	£560	£763	£918
BFT1810A	1800 x 1000	BFCT18S-I	£553	£758	£913
BFT1610A	1600 x 1000	BFCT16S-I	£539	£747	£898
BFT2008A	2000 x 800	BFCT20S-I	£539	£747	£898
BFT1808A	1800 x 800	BFCT18S-I	£522	£727	£881
BFT1608A	1600 x 800	BFCT16S-I	£517	£721	£872
BFT1408A	1400 x 800	BFCT14S-I	£507	£710	£863
BFT1208A	1200 x 800	BFCT12S-I	£443	£645	£798



Square Meeting Table

Intermediate End frames supplied (except 1000 x 1000)

BFT1616A	1600 x 1600	BFCT16D-I	£915	£1,118	N/A
BFT1414A	1400 x 1400	BFCT14D-I	£899	£1,102	N/A
BFT1212A	1200 x 1200	BFCT12D-I	£645	£850	£1,002
BFT1010A	1000 x 1000	BFCT10S-I	£448	£651	£805



Optional Cable Ports / Cut Outs

Standard cable port quantity and cutout quantity/positions are shown opposite.

When specifying - suffix the table code with the relevant letter.

Example of code - BFT1616ZC1 (25mm MFC top panel with 430mm x 132mm cut out)

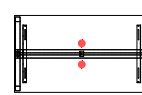

Rectangular - P
(and 1000 x 1000 Square)

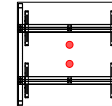

Square - P
(1200 x 1200 and over) - C

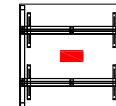

Square
(1200 x 1200 and over) - C



Circular - P

Code	Description	W	D	H	MFC Price
------	-------------	---	---	---	-----------

Reception Tables

Fully Welded 32mm Square Four Legged

25mm MFC top panels.

BRT106Z	Rectangular	1000 x	600 x	400	£448
BRT088Z	Square	800 x	800 x	400	£421
BRT066Z	Square	600 x	600 x	400	£355
BRTC08Z	Circular	Ø800	x	400	£448
BRTC06Z	Circular	Ø600	x	400	£428



BRT106Z

BRT088Z

BRTC08Z



Rectangular Starter Unit Angled Leg with Add-on Unit with Optional Service Modules

D3K TABLES

10 Year
Guarantee

- Fully welded robust construction free standing tables.
- Designed to work in the same environment as their desking counterpart.
- Available in a variety of sizes and footprints.
- For accessories and cable management refer to Cable Management in Desking section.



Tables

Code	Dimensions	Optional Cable Basket	Group Z 25mm MFC	Group B 36mm MFC	Group C 25mm Lam Kiko	Group D 25mm CH Lam Kiko		
Rectangular								
GTR2410	2400 x 1000	MECT14	£664	£867	£1,022	£1,100		
GTR2210	2200 x 1000	MECT10	£613	£819	£970	£1,051		
GTR2010	2000 x 1000	MECT10	£576	£781	£934	£1,012		
GTR1810	1800 x 1000	MECT06	£530	£732	£885	£965		
GTR1610	1600 x 1000	MECT06	£503	£703	£858	£937		
GTR1410	1400 x 1000	MECT06	£478	£687	£837	£916		
GTR24	2400 x 800	MECT14	£611	£817	£968	£1,050		
GTR22	2200 x 800	MECT10	£564	£765	£919	£998		
GTR20	2000 x 800	MECT10	£523	£728	£882	£962		
GTR18	1800 x 800	MECT06	£476	£679	£834	£914		
GTR16	1600 x 800	MECT06	£449	£655	£806	£885		
GTR14	1400 x 800	MECT06	£428	£632	£786	£863		
GTR12	1200 x 800	-	£406	£609	£762	£840		
Circular								
GTC16	ø1600	-	£649	£855	N/A	N/A		
GTC14	ø1400	-	£624	£827	N/A	N/A		
GTC12	ø1200	-	£591	£795	£948	£1,026		
GTC10	ø1000	-	£536	£738	£893	£973		
GTC08	ø800	-	£511	£719	£870	£950		
Square								
GTR1616	1600 x 1600	-	£618	£824	N/A	N/A		
GTR1414	1400 x 1400	-	£593	£796	N/A	N/A		
GTR1212	1200 x 1200	-	£560	£763	£918	£997		
GTR1010	1000 x 1000	-	£506	£709	£862	£942		
Boat Shaped								
GTB24	2400 x 1000 x 800	MECT14	£840	£1,045	£1,198	£1,278		
GTB22	2200 x 1000 x 800	MECT10	£793	£997	£1,150	£1,228		
GTB20	2000 x 1000 x 800	MECT10	£751	£952	£1,106	£1,186		
GTB18	1800 x 1000 x 800	MECT06	£699	£905	£1,057	£1,136		
GTB16	1600 x 1000 x 800	MECT06	£677	£883	£1,037	£1,116		
GTB14	1400 x 1000 x 800	MECT06	£659	£861	£1,014	£1,094		
GTB12	1200 x 1000 x 800	-	£636	£838	£993	£1,070		
Lozenge Shaped								
GTL24	2400 x 1000 x 800	MECT14	£882	£1,085	£1,238	£1,315		
GTL22	2200 x 1000 x 800	MECT10	£834	£1,038	£1,190	£1,270		
GTL20	2000 x 1000 x 800	MECT10	£790	£993	£1,146	£1,224		
Oval Shaped								
GTE16	1600 x 1100	-	£677	£883	£1,037	£1,116		
Boardroom End Table								
GBET16	1600 x 1400	MECT10	£782	£983	N/A	N/A		
GBET1612	1600 x 1200	MECT10	£727	£930	£1,084	£1,161		
Boardroom Centre Table								
GBCT14	1400 x 1400	MECT10	£552	£756	N/A	N/A		
GBCT1412	1400 x 1200	MECT10	£515	£720	£871	£951		

MFC Laminate

Sample footprints:

Seating capacities for guidance only and can differ depending on size of chair used.

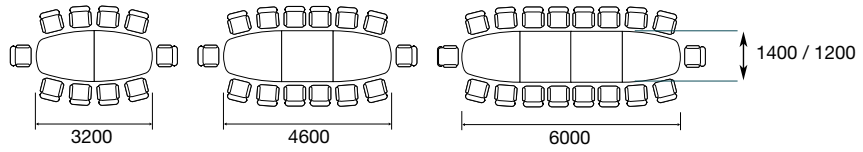

Optional Cable Ports / Cut Outs

Standard cable port quantity and cutout quantity/positions are shown opposite.

Example of code - GTR2010BC2.
(36mm MFC top panel with 272mm x 132mm cut out)

When specifying - suffix the table code with the relevant letter.

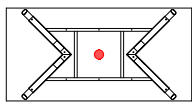

Rectangular P

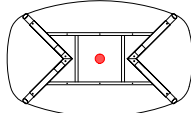

Lozenge P

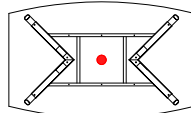

Boat P

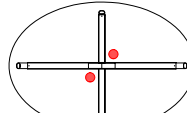

Oval P

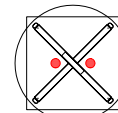

Square / Circular P

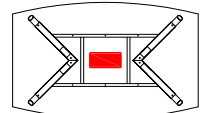

Boat C
GTB12 will not accept C1 cutout

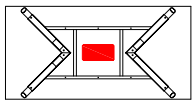

Rectangular C
GTR12 will not accept C1 cutout

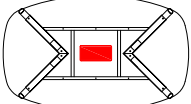

Lozenge C

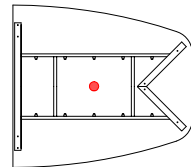

Large Format End P

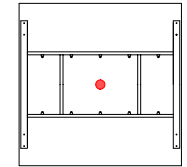

Large Format Centre P

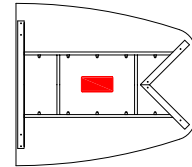

Large Format End C

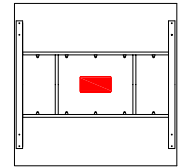

Large Format Centre C



Boardroom End Tables shown with Optional Service Modules

EX10 & X10 TABLES

10 Year
Guarantee

- Stylish and functional.
- Available in Panel Ended or Metal Frame.
- Available in a variety of sizes and footprints
- All EX10 tables have 25mm thick MFC panel ends.

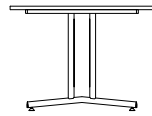

X10 Cantilever Frame
Rectangular, Boat,
Lozenge, Large Format

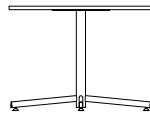

X10 Cross Frame
Circular, Square

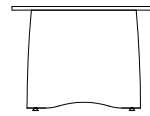

EX10 Panel End Frame
Rectangular, Boat,
Lozenge, Large Format

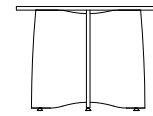

EX10 Panel Cross Frame
Circular, Square, Oval



Tables

EX10 Panel End	X10 Metal Frame	Dimensions	Optional Cable Basket Code	Group Z 25mm MFC	Group B 36mm MFC	Group C 25mm Lam Kiko	Group D 25mm CH Lam Kiko
Rectangular							
KNPTR2410	KNTR2410	2400 x 1000	MECT18	£651	£856	£1,008	£1,087
KNPTR2210	KNTR2210	2200 x 1000	MECT16	£606	£808	£963	£1,040
KNPTR2010	KNTR2010	2000 x 1000	MECT14	£553	£758	£913	£992
KNPTR1810	KNTR1810	1800 x 1000	MECT12	£510	£718	£869	£948
KNPTR1610	KNTR1610	1600 x 1000	MECT10	£486	£691	£841	£921
KNPTR1410	KNTR1410	1400 x 1000	MECT08	£467	£670	£824	£901
KNPTR24	KNTR24	2400 x 800	MECT18	£601	£802	£957	£1,037
KNPTR22	KNTR22	2200 x 800	MECT16	£552	£756	£911	£989
KNPTR20	KNTR20	2000 x 800	MECT14	£504	£706	£860	£938
KNPTR18	KNTR18	1800 x 800	MECT12	£461	£664	£819	£897
KNPTR16	KNTR16	1600 x 800	MECT10	£434	£638	£792	£870
KNPTR14	KNTR14	1400 x 800	MECT08	£415	£617	£770	£853
KNPTR12	KNTR12	1200 x 800	MECT06	£392	£595	£751	£828



Under frame is positioned to accept chairs at the end of the table

Circular

KNPTC16	-	ø1600	-	£642	£849	N/A	N/A
KNPTC14	-	ø1400	-	£613	£819	N/A	N/A
KNPTC12	KNTC12	ø1200	-	£530	£732	£885	£1,008
KNPTC10	KNTC10	ø1000	-	£482	£688	£838	£918
KNPTC08	KNTC08	ø800	-	£448	£651	£805	£884



Square

KNPTR1616	-	1600 x 1600	-	£492	£696	N/A	N/A
KNPTR1414	-	1400 x 1400	-	£453	£658	N/A	N/A
KNPTR1212	KNTR1212	1200 x 1200	-	£396	£603	£755	£834
KNPTR1010	KNTR1010	1000 x 1000	-	£373	£578	£732	£810



Boat Shaped

KNPTB24	KNTB24	2400 x 1000 x 800	MECT18	£831	£1,035	£1,188	£1,268
KNPTB22	KNTB22	2200 x 1000 x 800	MECT16	£783	£984	£1,141	£1,219
KNPTB20	KNTB20	2000 x 1000 x 800	MECT14	£733	£937	£1,089	£1,170
KNPTB18	KNTB18	1800 x 1000 x 800	MECT12	£691	£893	£1,046	£1,125
KNPTB16	KNTB16	1600 x 1000 x 800	MECT10	£664	£867	£1,022	£1,100
KNPTB14	KNTB14	1400 x 1000 x 800	MECT08	£640	£842	£998	£1,079
KNPTB12	KNTB12	1200 x 1000 x 800	MECT06	£616	£822	£974	£1,054



Under frame is positioned to accept chairs at the end of the table

Lozenge Shaped

KNPTL24	KNTL24	2400 x 1000 x 800	MECT18	£870	£1,074	£1,227	£1,305
KNPTL22	KNTL22	2200 x 1000 x 800	MECT16	£827	£1,028	£1,184	£1,263
KNPTL20	KNTL20	2000 x 1000 x 800	MECT14	£782	£983	£1,137	£1,218



Under frame is positioned to accept chairs at the end of the table

Oval Shaped

KNPTE16	-	1600 x 1100	-	£691	£893	£1,046	£1,125
---------	---	-------------	---	------	------	--------	--------

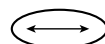

10 Year
Guarantee

EX10 & X10 TABLES

Tables

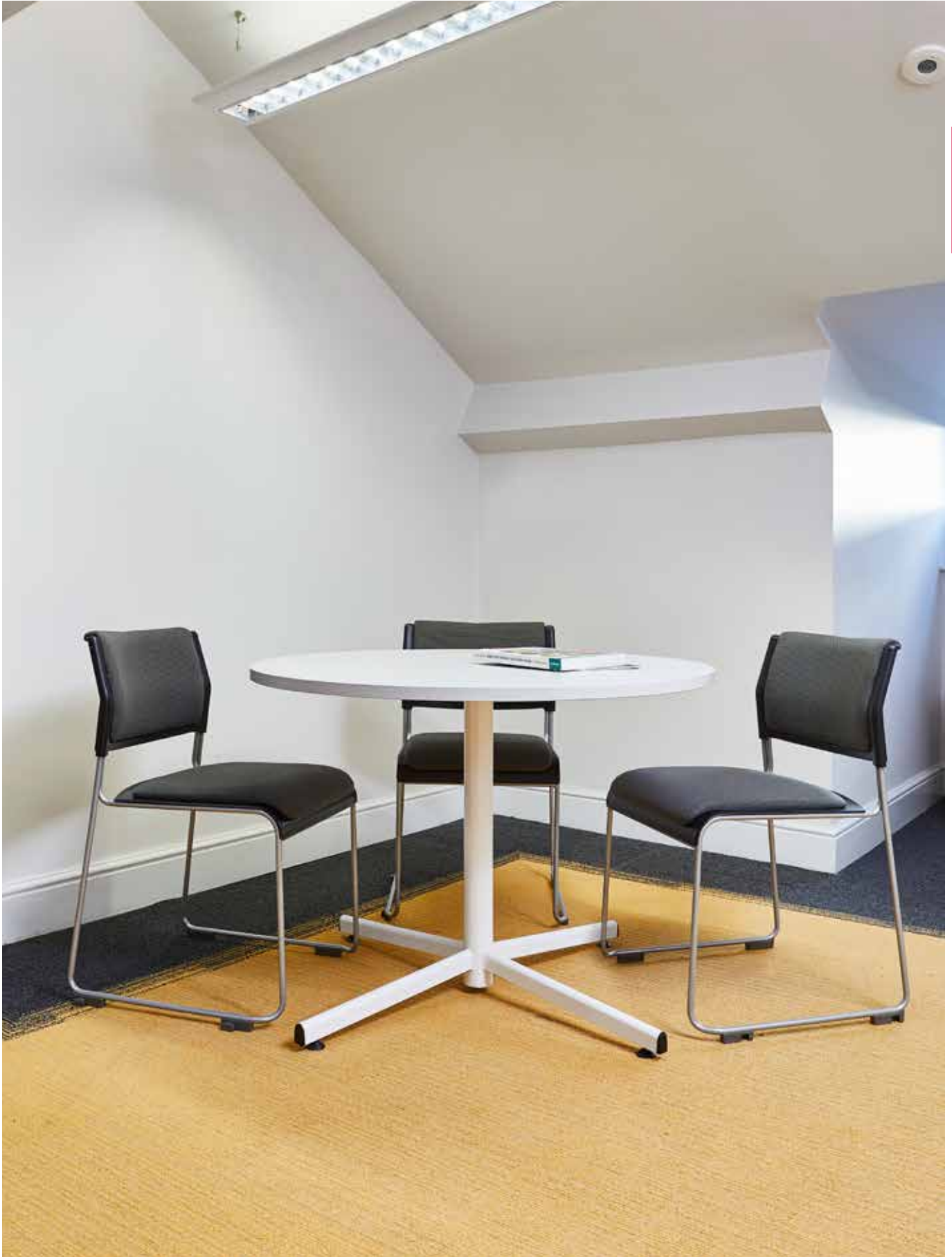

X10 Cross Frame Circular Shaped Table

EX10 LARGE FORMAT TABLES

10 Year Guarantee

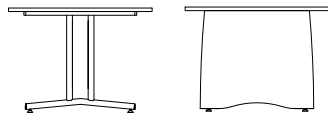

X10 Cantilever Frame
Rectangular, Boat, Lozenge, Large Format

EX10 Panel End Frame
Rectangular, Boat, Lozenge, Large Format



Tables

Large Format Tables - Starter & Add-on Units

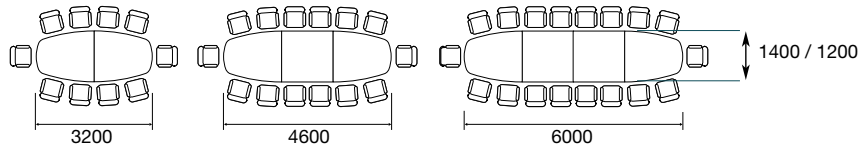

Sample footprints:

Seating capacities for guidance only and can differ depending on size of chair used.

EX10 Panel End	X10 Metal Frame	Dimensions	Optional Cable Basket Code	Group Z 25mm MFC	Group B 36mm MFC	Group C 25mm Lam Kiko	Group D 25mm CH Lam Kiko	MFC	Laminate
Starter Unit									
KNPBET16 KNPBET1612	KNBET16 KNBET1612	1600 x 1400 1600 x 1200	MECT12 MECT12	£834 £782	£1,038 £984	N/A £1,137	N/A £1,217		
Add-on End Unit									
KNPBET16A KNPBET1612A	KNBET16A KNBET1612A	1600 x 1400 1600 x 1200	MECT12 MECT12	£636 £582	£838 £789	N/A £938	N/A £1,020		
Add-on Centre Unit									
KNPBCT14A KNPBCT1412A	KNBCT14A KNBCT1412A	1400 x 1400 1400 x 1200	MECT14 MECT14	£636 £582	£838 £789	N/A £938	N/A £1,020		



EX10 Panel End Large Format Starter & Add-on End Unit

Optional Cable Ports / Cut Outs

Standard cable port quantity and cutout quantity/positions are shown opposite.

*Denotes inset leg by 300mm

When specifying - suffix the table code with the relevant letter.

Example of code - KNPTB24ZP
(EX10 Panel Ended boat shaped 25mm MFC top with cable ports)

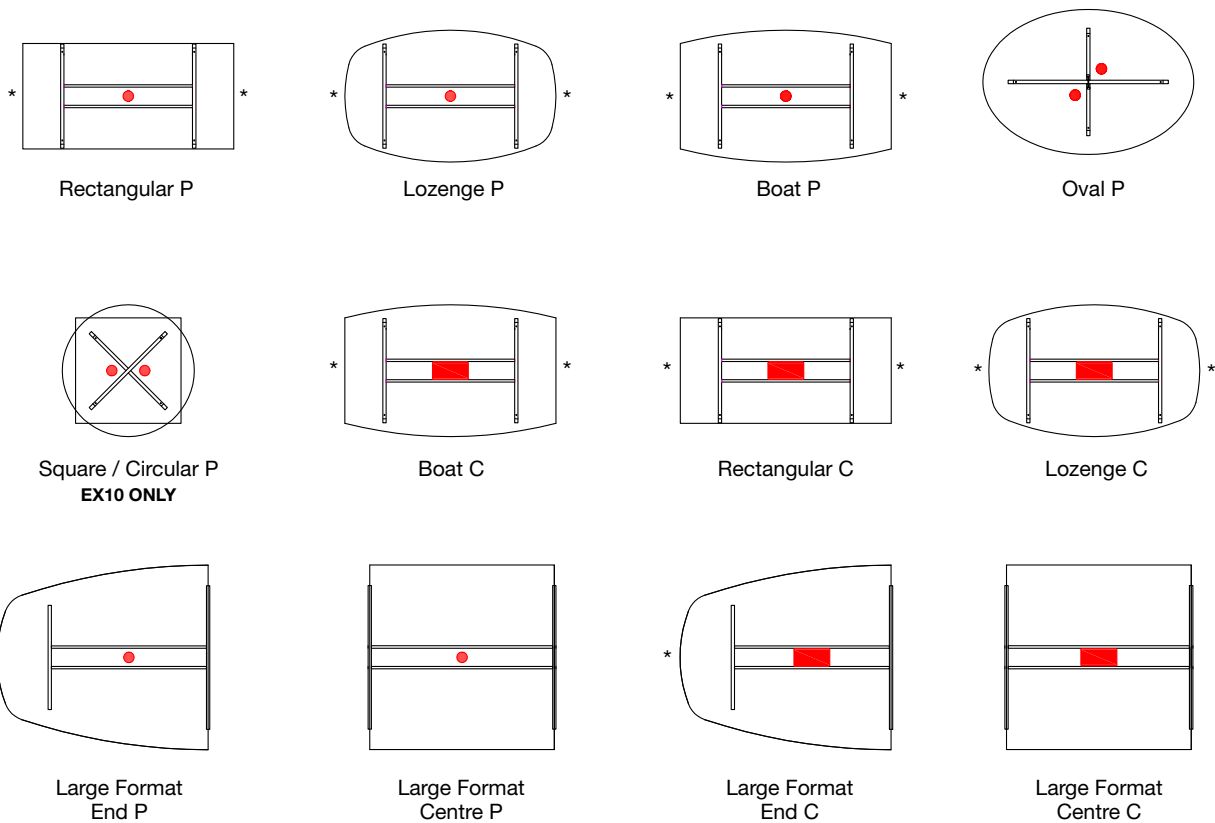

Cable Management

See Cable Management for cable baskets & cable spines.

Outer Leg Cover

Code	Where Used	Price
KNSECR	X10 Metal Frame	£40

Inner Riser Kit

Can only be used with outer leg covers.

Code	Where Used	Price
KNERI	X10 Metal Frame Inclusive of inner cover, cable restraints and plastic channels	£37



SCRIPT TABLES

10 Year
Guarantee

This simple but stylish table range features interconnecting underframes that provide strength whilst keeping the users knee space clear.

- Available with angled or straight legged options.
- Available in a large selection of footprints.
- K.D. product that is delivered then installed fully assembled.
- 25mm MFC top panels.



Leg styles

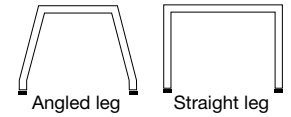

Tables

Angled Leg		Straight Leg		Dimensions	MFC Price	Angled Leg		Straight Leg		Dimensions	MFC Price
Dining Rectangular								Dining Circular			
XTA188	XTS188			1800 x 800	£428	XTAC16	XTSC16			ø1600	£552
XTA168	XTS168			1600 x 800	£410	XTAC14	XTSC14			ø1400	£498
XTA148	XTS148			1400 x 800	£393	XTAC12	XTSC12			ø1200	£445
XTA128	XTS128			1200 x 800	£372	XTAC10	XTSC10			ø1000	£393
XTA187	XTS187			1800 x 700	£421	XTAC08	XTSC08			ø800	£340
XTA167	XTS167			1600 x 700	£401						
XTA147	XTS147			1400 x 700	£385						
XTA127	XTS127			1200 x 700	£365						
Dining Square						Dining Lozenge Shaped					
XTAS12	XTSS12			1200 x 1200	£410	XTAL188	XTSL188			1800 x 800	£465
XTAS10	XTSS10			1000 x 1000	£322	XTAL168	XTSL168			1600 x 800	£445
XTAS08	XTSS08			800 x 800	£285	XTAL148	XTSL148			1400 x 800	£428
XTAS07	XTSS07			700 x 700	£277	XTAL128	XTSL128			1200 x 800	£410
XTAS06	XTSS06			600 x 600	£266						
Coffee - 455mm High		Top shape				Dining Rounded Corner Square					
XRTAC08	XRTSC08	Circular	Ø800		£285	XTAP12	XTSP12			1200 x 1200	£445
XRTAC06	XRTSC06	Circular	Ø600		£250	XTAP10	XTSP10			1000 x 1000	£358
XRTAS06	XRTSS06	Square	600 x 600		£217	XTAP08	XTSP08			800 x 800	£322
XRTA106	XRTS106	Rectangular	1000 x 600		£285	XTAP07	XTSP07			700 x 700	£312
XRTAL106	XRTSL106	Lozenge	1000 x 600		£305	XTAP06	XTSP06			600 x 600	£305
XRTAP06	XRTSP06	RC Square	600 x 600		£230						
Lounge - 575mm High		Top shape									
XTAC12L	XTSC12L	Circular	Ø1200		£445						
XTAC10L	XTSC10L	Circular	Ø1000		£393						
XTAC08L	XTSC08L	Circular	Ø800		£340						
XTAS08L		Square	800 x 800		£285						
XTAS07L		Square	700 x 700		£277						
XTAS06L		Square	600 x 600		£266						



Angled Leg Coffee Rectangular Table

This stylish three-sided table range is a good alternative to traditional circular and square offerings. Catering for small or medium user groups.



- Available with fully welded tubular steel frame or boxed panel supports.
- Available as a mobile option.
- Can be fitted with a central cable port for services.
- 25mm MFC top panels.

Metal Frame Code	Panel Support Code	A	B	C	MFC Price
------------------	--------------------	---	---	---	-----------

Static

TNF18	TNP18	1800 x	1800 x	1800	£536
TNF16	TNP16	1600 x	1600 x	1600	£520
TNF14	TNP14	1400 x	1400 x	1400	£490



Static with Central Cable Port

TNF18P	TNP18P	1800 x	1800 x	1800	£576
TNF16P	TNP16P	1600 x	1600 x	1600	£544
TNF14P	TNP14P	1400 x	1400 x	1400	£517



Metal Framed

Mobile with Central Cable Port

TNF18MP	-	1800 x	1800 x	1800	£667
TNF16MP	-	1600 x	1600 x	1600	£638
TNF14MP	-	1400 x	1400 x	1400	£616



Panel Support

DOC TABLES



These circular tables with a crescent scoop can be used individually or docked against each other to form fluid configurations.



- Supplied on fully welded steel frames with circular legs with options for Mobile or Static units.
- Work surface 'cut-outs' interlock with curved edges.
- 25mm MFC top panels.

Tables

Code A B MFC Price

Static Crescent Shaped

TPACS14	ø1400 x ø1400		£490
TPACS08	ø800 x ø800		£393



Mobile Crescent Shaped

TPACM14	ø1400 x ø1400		£537
TPACM08	ø800 x ø800		£443



Static Tablet Shaped

TTICS16	1600 x ø800 x ø800		£530
TTICS14	1400 x ø800 x ø800		£490



Mobile Tablet Shaped

TTICM16	1600 x ø800 x ø800		£577
TTICM14	1400 x ø800 x ø800		£537



Crescent Shaped

Frames are designed to swing together to reduce the overall footprint and save space when not needed.

- Supplied on fully welded steel frames with circular legs with options for Mobile or Static units.
- Resulting nest can be left in situ or moved flush against a wall.
- 25mm MFC top panels.

Surcharge for Pastel Paint – £32 per item



Code	A	B	MFC Price
Static Table			
TST22S	ø1900 x	ø2200	£1,115
Mobile Table			
TST22M	ø1900 x	ø2200	£1,115

Static Table

TST22S ø1900 x ø2200

£1,115

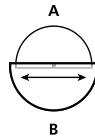

Mobile Table

TST22M ø1900 x ø2200

£1,115

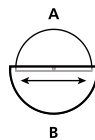

Swing Out

STAND HEIGHT TABLES

10 Year Guarantee

- Designed for use in touch-down areas for informal meetings.
- Continuous fully-welded steel frame with 50mm diameter circular legs.
- Available in a selection of footprints and two heights.
- 25mm MFC top panels.



Tables

Code A B C MFC Price

Rectangular Tables 1100mm High 800mm Deep

TS818RHZ	1800 x	800		£508
TS816RHZ	1600 x	800		£437
TS814RHZ	1400 x	800		£406
TS812RHZ	1200 x	800		£388
TS810RHZ	1000 x	800		£382



Rectangular Tables 1100mm High 600mm Deep

TS618RHZ	1800 x	600		£465
TS616RHZ	1600 x	600		£400
TS614RHZ	1400 x	600		£373
TS612RHZ	1200 x	600		£363
TS610RHZ	1000 x	600		£353



Peninsular Tables 1100mm High 800mm Deep

TS818PHZ	1800 x	800	x Ø1000	£559
TS816PHZ	1600 x	800	x Ø1000	£496
TS814PHZ	1400 x	800	x Ø1000	£473
TS812PHZ	1200 x	800	x Ø1000	£456

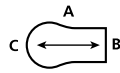

Peninsular Tables 1100mm High 600mm Deep

TS618PHZ	1800 x	600	x Ø800	£509
TS616PHZ	1600 x	600	x Ø800	£454
TS614PHZ	1400 x	600	x Ø800	£429
TS612PHZ	1200 x	600	x Ø800	£411

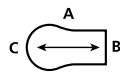

Circular Tables 1100mm High

TSC10HZ	Ø1000			£443
TSC08HZ	Ø800			£423



Code A B C MFC Price

Rectangular Tables 900mm High 800mm Deep

TS818RH9	1800 x	800		£491
TS816RH9	1600 x	800		£423
TS814RH9	1400 x	800		£393
TS812RH9	1200 x	800		£376
TS810RH9	1000 x	800		£369

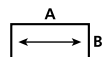

Rectangular Tables 900mm High 600mm Deep

TS618RH9	1800 x	600		£446
TS616RH9	1600 x	600		£384
TS614RH9	1400 x	600		£361
TS612RH9	1200 x	600		£345
TS610RH9	1000 x	600		£332

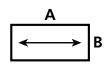

Peninsular Tables 900mm High 800mm Deep

TS818PH9	1800 x	800	x Ø1000	£538
TS816PH9	1600 x	800	x Ø1000	£478
TS814PH9	1400 x	800	x Ø1000	£454
TS812PH9	1200 x	800	x Ø1000	£435

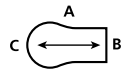

Peninsular Tables 900mm High 600mm Deep

TS618PH9	1800 x	600	x Ø800	£490
TS616PH9	1600 x	600	x Ø800	£434
TS614PH9	1400 x	600	x Ø800	£413
TS612PH9	1200 x	600	x Ø800	£396

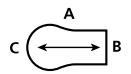

Circular Tables 900mm High

TSC10H9	Ø1000			£427
TSC08H9	Ø800			£403



Rectangular Stand Height Table

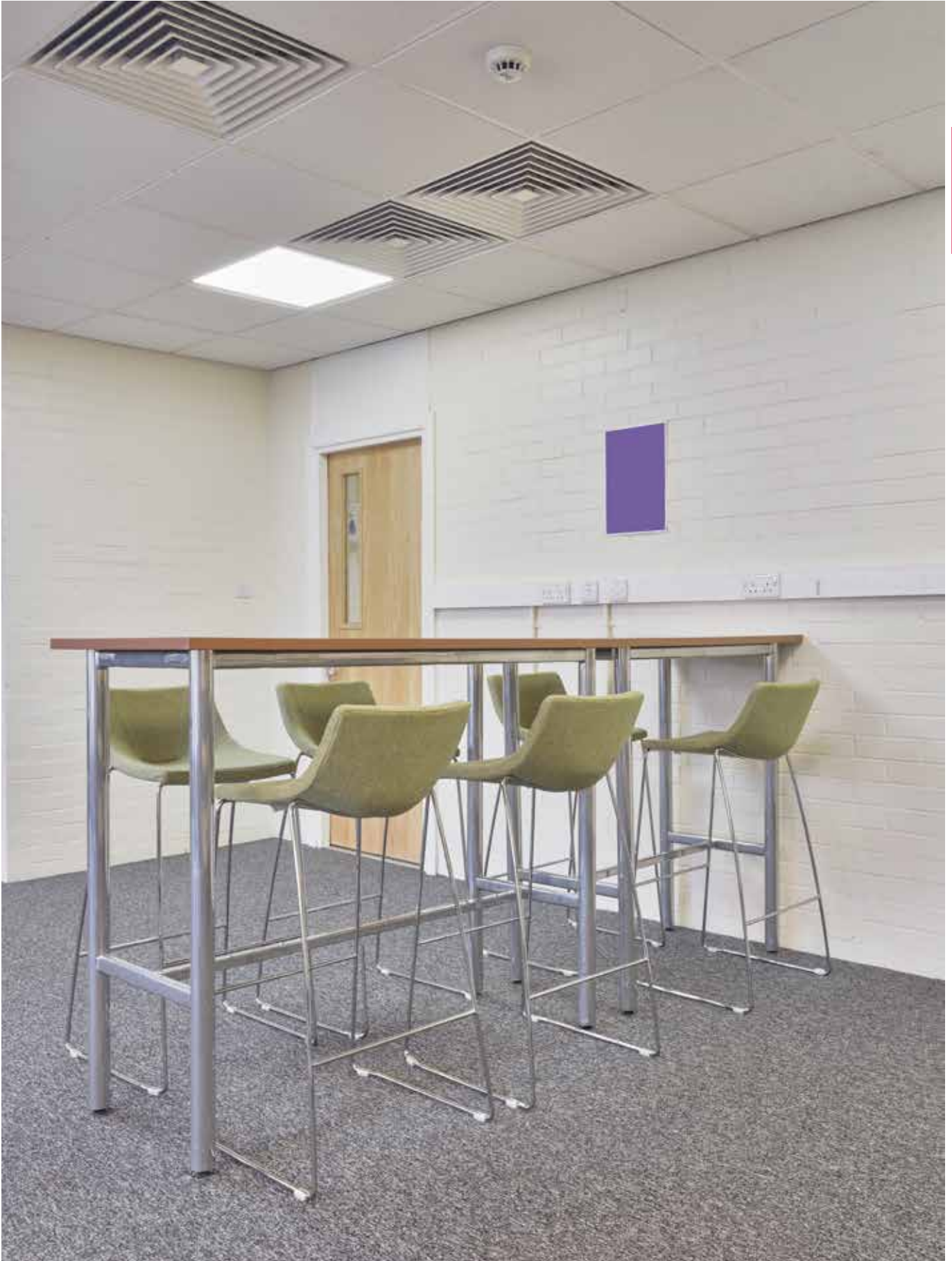

Rectangular Stand Height Table

GC1 TABLES

10 Year
Guarantee

GC1 is a family of mobile tables that can easily be reconfigured to suit agile working layouts then folded away and nested, when not in use. They also unique in that they have a simple 'sit-stand' height adjustable feature together with integrated power sockets.

Available Frame Colours

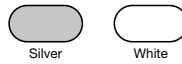

Maximum Load
Per Top (evenly distributed)



Tables

Tables with sockets

Code	A	B	Optional (Cable Basket)	Group Z 25mm MFC	Group C 25mm Lam Kiko	Group D 25mm CH Lam Kiko	Group F 25mm Drywipe
GC1C1	2000	1000	MECT20	£2,673	£3,010	£3,083	£3,206
GC1C2	1800	1000	MECT18	£2,661	£3,000	£3,071	£3,192
GC1C3	1600	1000	MECT16	£2,655	£2,995	£3,067	£3,189
GC1C4	1400	1000	MECT14	£2,651	£2,992	£3,062	£3,183
GC1D1	2000	800	MECT20	£2,623	£2,961	£3,035	£3,154
GC1D2	1800	800	MECT18	£2,612	£2,951	£3,023	£3,145
GC1D3	1600	800	MECT16	£2,609	£2,945	£3,017	£3,140
GC1D4	1400	800	MECT14	£2,604	£2,941	£3,014	£3,136



Mobile to static conversion kit

Set of four adjusters used to replace castors

GC1KIT1

£13

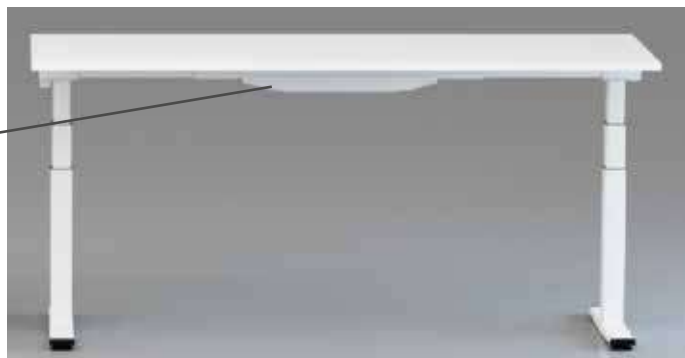
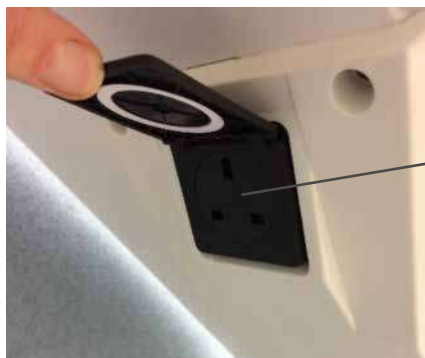
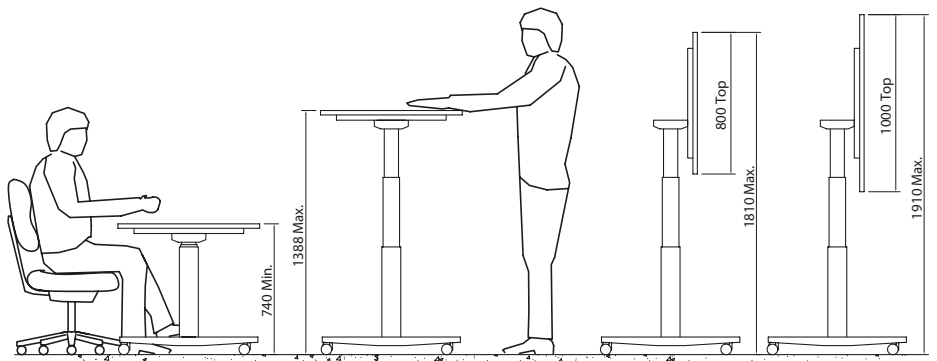

2 UK sockets accessible on the underside of the table.



GC4 TABLES



GC4 is a select family of tilt-top tables that feature elegant styling on complementary mobile and static frame designs that look great in any working landscape.

The mobile units are designed with the frames positioned to the ends of the table to allow users to sit comfortably to both sides. The static versions have inset frames, allowing users to sit to all sides.

Available Frame Colours

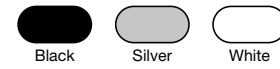

Tables

Code	Dimensions	Optional Cable Tray Code	Group Z 25mm MFC	Group C 25mm Lam Kiko	Group D 25mm CH Lam Kiko
*No linking on 25mm CH Lam top					
Mobile Tilt Top					
GC4A1	1800 x 800	MECT18	£997	£1,334	£1,409
GC4A2	1600 x 800	MECT16	£970	£1,310	£1,382
GC4A3	1400 x 800	MECT14	£945	£1,283	£1,356
GC4A4	1200 x 800	MECT12	£926	£1,265	£1,335
GC4A5	1000 x 800	MECT10	£916	£1,254	£1,328
GC4B1	1800 x 700	MECT18	£953	£1,291	£1,364
GC4B2	1600 x 700	MECT16	£927	£1,267	£1,339
GC4B3	1400 x 700	MECT14	£900	£1,240	£1,312
GC4B4	1200 x 700	MECT12	£883	£1,222	£1,294
GC4B5	1000 x 700	MECT10	£871	£1,211	£1,283



Mobile Tilt Top



Mobile Tilt Top Nested



Static Inset Leg Tilt Top



Code	Dimensions	Optional Cable Tray Code	Group Z 25mm MFC	Group C 25mm Lam Kiko	Group D 25mm CH Lam Kiko
*No linking on 25mm CH Lam top					
Static Inset Leg Tilt Top Leg frames inset by 300mm each side					
GC4C1	2400 x 800	MECT18	£1,012	£1,348	£1,422
GC4C2	2200 x 800	MECT16	£996	£1,326	£1,396
GC4C3	2000 x 800	MECT14	£959	£1,299	£1,370
GC4C4	1800 x 800	MECT12	£941	£1,280	£1,351
GC4C5	1600 x 800	MECT10	£930	£1,269	£1,341
GC4D1	2400 x 1000/800	MECT18	£1,039	£1,377	£1,450
GC4D2	2200 x 1000/800	MECT16	£1,013	£1,351	£1,424
GC4D3	2000 x 1000/800	MECT14	£985	£1,327	£1,397
GC4D4	1800 x 1000/800	MECT12	£967	£1,305	£1,380
GC4D5	1600 x 1000/800	MECT10	£957	£1,298	£1,369

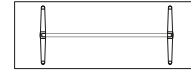

Code	A	B	MFC Price
------	---	---	-----------

Suspended Modesty Panels
Fits to Appropriate Table Beams

DRCPW18	1750 x 300	£101
DRCPW16	1550 x 300	£95
DRCPW14	1350 x 300	£89
DRCPW12	1150 x 300	£78
DRCPW10	950 x 300	£74
DRCPW08	750 x 300	£68



Code	Table Size	L	W	Price
MECT18	1800	1629	116	£86
MECT16	1600	1426	116	£82
MECT14	1400	1222	116	£81
MECT12	1200	1019	116	£76
MECT10	1000	816	116	£73



Code	Price
Table Connector Set Pair of link plates & fittings *No linking on 25mm CH Lam top	
CONLINK	£26



TELFORD TILT TOP TABLES



This is our most popular mobile table range. They are simple to use with a robust construction.

- Robust construction. Endframes fitted with castors.
- Simple, one-handed operation.
- Can be moved and nested.
- Available in a selection of footprints.
- 25mm MFC top panels.

Available Frame Colours

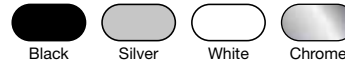

Tables

Code	A	B	White/Silver Black Frame MFC Price	Chrome Frame MFC Price
Rectangular 600mm				
DRMT186Z	1800	x 600	£591	£725
DRMT166Z	1600	x 600	£567	£689
DRMT146Z	1400	x 600	£539	£668
DRMT126Z	1200	x 600	£526	£636
DRMT106Z	1000	x 600	£518	£631
DRMT086Z	800	x 600	£508	£623



Code	A	B	C	White/Silver Black Frame MFC Price	Chrome Frame MFC Price
Rectangular 800mm					
DRMT188Z	1800	x 800		£668	£808
DRMT168Z	1600	x 800		£641	£780
DRMT148Z	1400	x 800		£616	£761
DRMT128Z	1200	x 800		£598	£729
DRMT108Z	1000	x 800		£587	£714
DRMT088Z	800	x 800		£577	£701

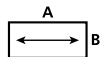

Code	A	B	White/Silver Black Frame MFC Price	Chrome Frame MFC Price
Rectangular 700mm				
DRMT187Z	1800	x 700	£625	£763
DRMT167Z	1600	x 700	£595	£727
DRMT147Z	1400	x 700	£574	£702
DRMT127Z	1200	x 700	£553	£677
DRMT107Z	1000	x 700	£545	£668
DRMT087Z	800	x 700	£535	£654



Code	A	B	C	White/Silver Black Frame MFC Price	Chrome Frame MFC Price
Trapezium					
DTMT16Z	1600	x 800	x 800	£641	£780
DTMT14Z	1400	x 700	x 700	£595	£727

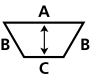

Rectangular Tilt Top Tables

10 Year
Guarantee

TELFORD TILT TOP TABLES

Code A B

Semi-Circular

DSMT16Z ϕ 1600 x 800
DSMT14Z ϕ 1400 x 700

White/Silver Black Frame MFC Price	Chrome Frame MFC Price
£641	£780
£595	£727

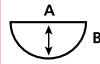

Circular

DCMT12Z ϕ 1200
DCMT10Z ϕ 1000

£645	£780
£595	£727



Rectangular Tables Nested

Code A B

Suspended Modesty Panels

Fits to Appropriate Table Beams

DRCPW18 1750 x 300
DRCPW16 1550 x 300
DRCPW14 1350 x 300
DRCPW12 1150 x 300
DRCPW10 950 x 300
DRCPW08 750 x 300

£101
£95
£89
£78
£74
£68



Code Table Size L W

Optional Cable Baskets

MECT18 1800 1629
MECT16 1600 1426
MECT14 1400 1222
MECT12 1200 1019
MECT10 1000 816

116 116 116 116 116

Price

£86
£82
£81
£76
£73



Code

Table Connector Set

Pair of link plates & fittings
*No linking on 25mm CH Lam top

CONLINK

Price

£26



Rectangular Tilt Top Tables

TELFORD FIXED TOP TABLES



Complementing our popular Tilt Top range, this Fixed Top static table offers the perfect solution for configured layouts or stand alone applications.

- Robust construction. Endframes fitted with levelling feet.
- Complements our Tilt Top range.
- Available in a selection of footprints.
- 25mm MFC top panels.

Available Frame Colours

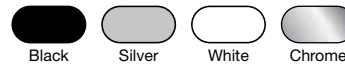

Tables

Code	A	B	C	White/Silver Black Frame MFC Price	Chrome Frame MFC Price
Rectangular 800mm					
DRFT168Z	1600	x	800	£586	£724
DRFT148Z	1400	x	800	£567	£699
DRFT128Z	1200	x	800	£539	£670
DRFT108Z	1000	x	800	£531	£660
DRFT088Z	800	x	800	£520	£647



Code	A	B	White/Silver Black Frame MFC Price	Chrome Frame MFC Price	
Rectangular Tables 700mm					
DRFT167Z	1600	x	700	£549	£669
DRFT147Z	1400	x	700	£523	£645
DRFT127Z	1200	x	700	£503	£624
DRFT107Z	1000	x	700	£496	£610
DRFT087Z	800	x	700	£486	£600

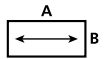

Code	A	B	C	White/Silver Black Frame MFC Price	Chrome Frame MFC Price		
Trapezium							
DTFT16Z	1600	x	800	x	800	£588	£724
DTFT14Z	1400	x	700	x	700	£549	£669



Code	A	B	MFC Price	
Suspended Modesty Panels Fits to Appropriate Table Beams				
DRCPW16	1550	x	300	£95
DRCPW14	1350	x	300	£89
DRCPW12	1150	x	300	£78
DRCPW10	950	x	300	£74
DRCPW08	750	x	300	£68

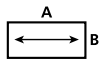

Code	A	B	White/Silver Black Frame MFC Price	Chrome Frame MFC Price	
Semi Circular					
DSFT16Z	ø1600	x	800	£588	£724
DSFT14Z	ø1400	x	700	£549	£669



Code	A	B	White/Silver Black Frame MFC Price	Chrome Frame MFC Price
Circular Tables				
DCFT12Z	ø1200		£594	£725
DCFT10Z	ø1000		£545	£669



Code	MFC Price
Table Connector Set Pair of link plates & fittings	
CONLINK	£26



Rectangular Tilt Top Tables

TELFORD FOLDING LEG TABLES

- 'I' frame or cow horn frame folding leg mechanism with robust construction.
- Tables fold flat for storage.
- Storage trolley designed to fit through single door.
- Available with a choice of Black, Grey, Silver, White or Chrome legs.
- Cow horn legs designed for seating at all sides.
- 25mm MFC top panels.



'I' Frame Table

Cow Horn Table

Examples of configurations

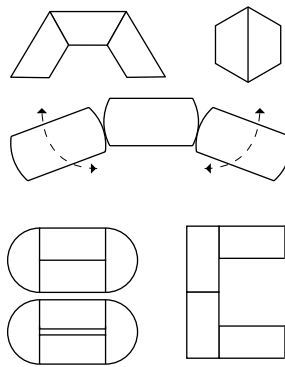

TFLT

Tables

'I' Frame Code	Cow Horn Code	A	B	MFC Price
Rectangular				
T818FZ	C818FZ	1800 x 800		£515
T816FZ	C816FZ	1600 x 800		£455
T814FZ	C814FZ	1400 x 800		£428
T812FZ	C812FZ	1200 x 800		£407
T718FZ	N/A	1800 x 700		£495
T716FZ	N/A	1600 x 700		£427
T714FZ	N/A	1400 x 700		£398
T712FZ	N/A	1200 x 700		£379

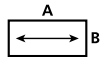

'I' Frame Code	Cow Horn Code	A	B	C	MFC Price
Convex Shape					
T818CFZ	C818CFZ	1800 x 800			£553
T816CFZ	C816CFZ	1600 x 800			£519
T714CFZ	N/A	1400 x 700			£490
Trapezium					
TT816FZ	CTT816FZ	1600 x 800	x 800		£525
TT714FZ	N/A	1400 x 700	x 700		£495
Semi-Circular					
TSC16FZ	CSC16FZ	ø1600 x 800			£507
TSC14FZ	N/A	ø1400 x 700			£477

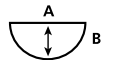
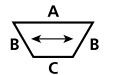
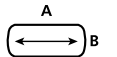

Code **Dimensions**

Folding Leg Trolley
Accepts up to 5 tables folded, available in Black or Grey finish.

TFLT	1540 x 650 x 960 (Overall size)	£553
	1340 x 600 x 450 (Internal size)	



Cow Horn Rectangular Table

TELFORD ADAPT TABLES



- Robustly constructed with continuous welded frame.
- Available in a variety of sizes and footprints.
- 727mm High with 25mm MFC top panels.

Surcharge for Pastel Paint – £32 per item

CONLINK Table Connector Set £26

Examples of configurations

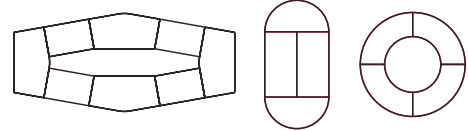

Tables

Code A B MFC Price

800mm Rectangular

NT816RZ	1600 x 800	£394
NT814RZ	1400 x 800	£369
NT812RZ	1200 x 800	£355
NT808RZ	800 x 800	£322



700mm Rectangular

NT716RZ	1600 x 700	£386
NT714RZ	1400 x 700	£361
NT712RZ	1200 x 700	£345
NT708RZ	700 x 700	£311



Trapezium

NT816TZ	1600 x 800 x 800	£483
NT714TZ	1400 x 700 x 700	£468



Semi-Circular

NT816SZ	1600 x 800	£483
NT714SZ	1400 x 700	£468



Shell

NT816LZ	1711 x 800 x R1210	£630
NT714LZ	1570 x 700 x R1110	£598



Arc

NT816AZ	1600 x 800	£606
NT714AZ	1400 x 700	£574

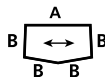

Pentagonal

NT816PZ	1600 x 800	£606
NT714PZ	1400 x 700	£574

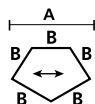

700mm Rectangular

NT16CZ	Ø1600	£492
NT14CZ	Ø1400	£467
NT12CZ	Ø1200	£425
NT10CZ	Ø1000	£394



Suspended Modesty Panels

NTCPW16	1600 x 300	£95
NTCPW14	1400 x 300	£89
NTCPW12	1200 x 300	£78



TELFORD SEGMENT TABLES

- Mobile Segment tables are the perfect choice for adaptive workspaces.
- Compact but deceptively strong, available with either Fixed or Tilt-top for nesting.

Only 18mm MFC Top Panels on Segment tables.

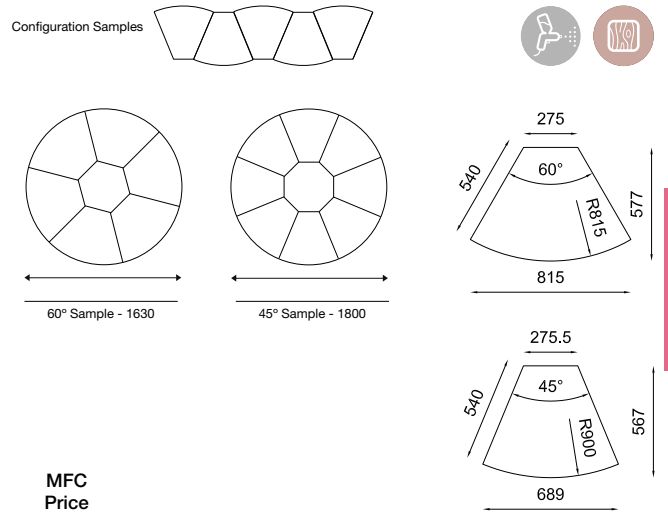

Code	W	D	H	MFC Price				
45° Fixed Top								
TMSF45	689	x	567	x	720	£280		
60° Fixed Top								
TMSF60	815	x	577	x	720	£280		
Code	W	D	H	Height when Tilted	MFC Price			
45° Tilt Top								
TMST45	689	x	567	x	720	1150	£448	
60° Tilt Top								
TMST60	815	x	577	x	720	1160	£448	
Linking Kit								
TMSLK							£32	



45° Tilt Top Segment Tables

MULTI-PURPOSE STATIC BTC & CTC TABLES

25 Year Structural Guarantee

A range of multi-purpose tables with fully-welded steel frames that combine aesthetic appeal with strength and stability.

- Available in a selection of footprints and finishes.
- Available with either round or square legged options.
- 25mm MFC top panels.



Tables

Ø35mm Circular Leg	40mm Square Leg	A	B	MFC Price
--------------------	-----------------	---	---	-----------

Rectangular 800mm Deep

CTC188Z	BTC188Z	1800 x 800	£415
CTC168Z	BTC168Z	1600 x 800	£389
CTC148Z	BTC148Z	1400 x 800	£360
CTC138Z	BTC138Z	1300 x 800	£342
CTC128Z	BTC128Z	1200 x 800	£327
CTC108Z	BTC108Z	1000 x 800	£311
CTC088Z	BTC088Z	800 x 800	£302

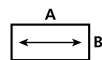

Rectangular 700mm Deep

CTC187Z	BTC187Z	1800 x 700	£376
CTC167Z	BTC167Z	1600 x 700	£352
CTC147Z	BTC147Z	1400 x 700	£326
CTC137Z	BTC137Z	1300 x 700	£311
CTC127Z	BTC127Z	1200 x 700	£300
CTC107Z	BTC107Z	1000 x 700	£277
CTC087Z	BTC087Z	800 x 700	£260
CTC077Z	BTC077Z	700 x 700	£257

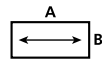

Rectangular 600mm & 650mm Deep

CTC186Z	BTC186Z	1800 x 600	£340
CTC166Z	BTC166Z	1600 x 600	£312
CTC146Z	BTC146Z	1400 x 600	£291
CTC136Z	BTC136Z	1300 x 600	£280
CTC126Z	BTC126Z	1200 x 600	£273
CTC106Z	BTC106Z	1000 x 600	£244
CTC086Z	BTC086Z	800 x 600	£242
CTC065Z	BTC065Z	650 x 650	£218
CTC066Z	BTC066Z	600 x 600	£218

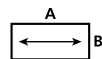

Ø35mm Circular Leg	40mm Square Leg	A	B	C	MFC Price
--------------------	-----------------	---	---	---	-----------

Trapezium

CTT188Z	BTT188Z	1800 x 800	1000	£504
CTT168Z	BTT168Z	1600 x 800	800	£475
CTT147Z	BTT147Z	1400 x 700	700	£429
CTT128Z	BTT128Z	1200 x 800	400	£386
CTT126Z	BTT126Z	1200 x 600	600	£352

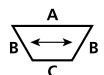

Semi-circular

CSC18Z	BSC18Z	Ø1800 x 900	£504
CSC16Z	BSC16Z	Ø1600 x 800	£475
CSC14Z	BSC14Z	Ø1400 x 700	£429
CSC12Z	BSC12Z	Ø1200 x 600	£386

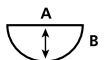

Circular

CCC16Z	BCC16Z	Ø1600	£566
CCC14Z	BCC14Z	Ø1400	£536
CCC12Z	BCC12Z	Ø1200	£504
CCC10Z	BCC10Z	Ø1000	£467
CCC08Z	BCC08Z	Ø800	£435



Rectangular BTC Static Tables

MULTI-PURPOSE MOBILE BTC & CTC TABLES

A range of mobile multi-purpose tables with fully-welded steel frames that combine aesthetic appeal with strength and stability.

- Fitted with lockable castors.
- Available in a selection of footprints and finishes.
- Available with either round or square legged options.
- 25mm MFC top panels.



Ø35mm Circular Leg	40mm Square Leg	A	B	MFC Price
Rectangular 800mm Deep				
CTC188M	BTC188M	1800 x	800	£463
CTC168M	BTC168M	1600 x	800	£435
CTC148M	BTC148M	1400 x	800	£406
CTC138M	BTC138M	1300 x	800	£391
CTC128M	BTC128M	1200 x	800	£372
CTC108M	BTC108M	1000 x	800	£360
CTC088M	BTC088M	800 x	800	£351



Ø35mm Circular Leg	40mm Square Leg	A	B	MFC Price
Rectangular 700mm Deep				
CTC187M	BTC187M	1800 x	700	£424
CTC167M	BTC167M	1600 x	700	£396
CTC147M	BTC147M	1400 x	700	£371
CTC137M	BTC137M	1300 x	700	£360
CTC127M	BTC127M	1200 x	700	£346
CTC107M	BTC107M	1000 x	700	£324
CTC087M	BTC087M	800 x	700	£306
CTC077M	BTC077M	700 x	700	£304



Ø35mm Circular Leg	40mm Square Leg	A	B	MFC Price
Rectangular 600mm & 650mm Deep				
CTC186M	BTC186M	1800 x	600	£388
CTC166M	BTC166M	1600 x	600	£361
CTC146M	BTC146M	1400 x	600	£338
CTC136M	BTC136M	1300 x	600	£328
CTC126M	BTC126M	1200 x	600	£321
CTC106M	BTC106M	1000 x	600	£290
CTC086M	BTC086M	800 x	600	£287
CTC065M	BTC065M	650 x	650	£264
CTC066M	BTC066M	600 x	600	£264



Ø35mm Circular Leg	40mm Square Leg	A	B	C	MFC Price
Trapezium					
CTT188M	BTT188M	1800 x	800 x	1000	£550
CTT168M	BTT168M	1600 x	800 x	800	£522
CTT147M	BTT147M	1400 x	700 x	700	£476
CTT128M	BTT128M	1200 x	800 x	400	£432
CTT126M	BTT126M	1200 x	600 x	600	£396



Ø35mm Circular Leg	40mm Square Leg	A	B	MFC Price
Semi-Circular				
CSC18M	BSC18M	Ø1800 x	900	£550
CSC16M	BSC16M	Ø1600 x	800	£522
CSC14M	BSC14M	Ø1400 x	700	£476
CSC12M	BSC12M	Ø1200 x	600	£432



Ø35mm Circular Leg	40mm Square Leg	A	MFC Price
Circular			
CCC16M	BCC16M	Ø1600	£611
CCC14M	BCC14M	Ø1400	£583
CCC12M	BCC12M	Ø1200	£550
CCC10M	BCC10M	Ø1000	£511
CCC08M	BCC08M	Ø800	£483



Square CTC Mobile Tables

MULTI-PURPOSE STC TABLES

25 Year Structural Guarantee

A range of multi-purpose tables with fully-welded steel frames that combine simplicity with strength and stability.

- Available in a selection of footprints.
- Rectangular tables can be spirally stacked.
- 25mm MFC top panels.



25mm Square Leg



Tables

Code	A	B	MFC Price
Rectangular 800mm Deep			
STC188Z	1800 x	800	£312
STC168Z	1600 x	800	£297
STC148Z	1400 x	800	£270
STC138Z	1300 x	800	£255
STC128Z	1200 x	800	£241
STC108Z	1000 x	800	£225
STC088Z	800 x	800	£218



Code	A	B	MFC Price
Rectangular 700mm Deep			
STC187Z	1800 x	700	£290
STC167Z	1600 x	700	£270
STC147Z	1400 x	700	£245
STC137Z	1300 x	700	£230
STC127Z	1200 x	700	£219
STC107Z	1000 x	700	£205
STC087Z	800 x	700	£196
STC077Z	700 x	700	£192



Code	A	B	MFC Price
Rectangular 600mm & 650mm Deep			
STC186Z	1800 x	600	£251
STC166Z	1600 x	600	£226
STC146Z	1400 x	600	£211
STC136Z	1300 x	600	£198
STC126Z	1200 x	600	£187
STC106Z	1000 x	600	£177
STC086Z	800 x	600	£160
STC065Z	650 x	650	£148
STC066Z	600 x	600	£148



Code	A	B	C	MFC Price
Trapezium				
TT188Z	1800 x	800 x	1000	£406
TT168Z	1600 x	800 x	800	£361
TT147Z	1400 x	700 x	700	£327
TT128Z	1200 x	800 x	400	£275
TT126Z	1200 x	600 x	600	£231

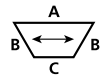

Code	A	B	MFC Price
Semi-Circular			
SCT18Z	Ø1800 x	900	£401
SCT16Z	Ø1600 x	800	£358
SCT14Z	Ø1400 x	700	£322
SCT12Z	Ø1200 x	600	£254

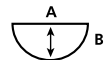

Code	A	MFC Price
Circular		
FTC16Z	Ø1600	£465
FTC14Z	Ø1400	£445
FTC12Z	Ø1200	£427
FTC10Z	Ø1000	£388
FTC08Z	Ø800	£360



Code	Description	W	D	H	MFC Price
Reception Tables					
Fully Welded 25mm Square Four Legged					
25mm MFC top panels.					
STC104Z	Rectangular	1000 x	600 x	400	£178
STC064Z	Square	600 x	600 x	400	£155
STE104Z	Oval	1000 x	600 x	400	£299
FTC084Z	Circular	Ø800	x	400	£259
FTC064Z	Circular	Ø600	x	400	£188



Rectangular STC Table

- Selected additional Tables for meeting and conference requirements.
- Available in a variety of sizes and footprints.
- 727mm High with 25mm MFC top panels unless otherwise stated.



Code A B Price

800mm Flush Frame Rectangular Table
Continuous welded Steel Frame

CON18Z	1800 x 800	£417
CON16Z	1600 x 800	£367
CON14Z	1400 x 800	£350
CON12Z	1200 x 800	£333



800mm Inset Frame Rectangular Table
Continuous welded Steel Frame

CON18EZ	1800 x 800	£417
CON16EZ	1600 x 800	£367
CON14EZ	1400 x 800	£350
CON12EZ	1200 x 800	£333



800mm D-End Frame Table
Continuous welded Steel Frame

CON20DZ	2000 x 800	£490
CON18DZ	1800 x 800	£439
CON16DZ	1600 x 800	£389



Code Description W D H MFC Price

Fully Welded 50mm Diameter Circular Four Legged
25mm MFC top panels.

PR106Z	Rectangular	1000 x 600 x 400	£370
PR6Z	Square	600 x 600 x 400	£245
PR7Z	Boat shaped	1000 x 600 x 400	£370
SAVCT2	Oval	1000 x 600 x 400	£370
PC8Z	Circular	Ø800 x 400	£428
PC6Z	Circular	Ø600 x 400	£306

Code A MFC Price

**Circular Meeting Tables -
ø50mm Circular Legs**

TC16RZ	Ø1600	£494
TC14RZ	Ø1400	£468
TC12RZ	Ø1200	£437
TC10RZ	Ø1000	£395
TC08RZ	Ø800	£373



**Circular Meeting Tables -
Cross Frame**

CCT16Z	Ø1600	£632
CCT14Z	Ø1400	£586
CCT12Z	Ø1200	£549
CCT10Z	Ø1000	£492
CCT08Z	Ø800	£443



PR7Z

PC6Z

PR6Z



Circular Meeting Table with Cross Frame

LTA TABLES

10 Year
Guarantee

- Black Cross Base design.
- Available in Circular, Square and Rectangular footprints.



Tables

Code	Top Shape	Top Size	Group Z 25mm MFC	Group B 36mm MFC	Group C 25mm Lam Kiko	Group D 25mm CH Lam Kiko
Coffee - 455mm High						
LTA06CR	Circular	ø600	£250	£454	£608	£689
LTA66R	Square	600 x 600	£242	£444	£598	£675



Lounge - 575mm High

LTA06CL	Circular	ø600	£266	£472	£625	£702
LTA07CL	Circular	ø700	£286	£490	£641	£722
LTA08CL	Circular	ø800	£308	£510	£666	£747
LTA09CL	Circular	ø900	£324	£529	£679	£760
LTA10CL	Circular	ø1000	£345	£549	£700	£782
LTA66L	Square	600 x 600	£260	£464	£616	£696
LTA77L	Square	700 x 700	£278	£482	£636	£716
LTA88L	Square	800 x 800	£299	£503	£656	£733



Dining - 745mm High

LTA06CD	Circular	ø600	£266	£472	£625	£702
LTA07CD	Circular	ø700	£286	£490	£641	£722
LTA08CD	Circular	ø800	£308	£510	£666	£747
LTA09CD	Circular	ø900	£324	£529	£679	£760
LTA10CD	Circular	ø1000	£345	£549	£700	£782
LTA66D	Square	600 x 600	£260	£464	£616	£696
LTA77D	Square	700 x 700	£278	£482	£636	£716
LTA88D	Square	800 x 800	£299	£503	£656	£733



Twin Pedestal Dining - 745mm High

LTA127D	Rectangular	1200 x 700	£429	£635	£789	£866
LTA147D	Rectangular	1400 x 700	£461	£664	£819	£897
LTA128D	Rectangular	1200 x 800	£438	£641	£796	£873
LTA148D	Rectangular	1400 x 800	£472	£674	£828	£906



Mid Poseur - 905mm High

LTA06CMP	Circular	ø600	£316	£519	£673	£753
LTA66MP	Square	600 x 600	£308	£510	£666	£747

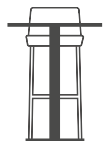

Poseur - 1125mm High

LTA06CP	Circular	ø600	£316	£519	£673	£753
LTA66P	Square	600 x 600	£308	£510	£666	£747

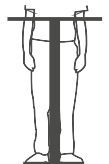



- Chrome Cross Base design.
- Available in Circular, Square and Rectangular footprints.



Code	Top Shape	Top Size	Group Z 25mm MFC	Group B 36mm MFC	Group C 25mm Lam Kiko	Group D 25mm CH Lam Kiko
Coffee - 455mm High						
LTC06CR	Circular	ø600	£355	£555	£710	£791
LTC66R	Square	600 x 600	£345	£549	£700	£782



Lounge - 575mm High

LTC06CL	Circular	ø600	£371	£576	£729	£808
LTC07CL	Circular	ø700	£393	£598	£752	£829
LTC08CL	Circular	ø800	£411	£615	£768	£849
LTC09CL	Circular	ø900	£429	£635	£789	£866
LTC10CL	Circular	ø1000	£449	£655	£806	£885
LTC66L	Square	600 x 600	£364	£568	£722	£799
LTC77L	Square	700 x 700	£384	£584	£736	£819
LTC88L	Square	800 x 800	£401	£606	£758	£837



Dining - 745mm High

LTC06CD	Circular	ø600	£371	£576	£729	£808
LTC07CD	Circular	ø700	£393	£598	£752	£829
LTC08CD	Circular	ø800	£411	£615	£768	£849
LTC09CD	Circular	ø900	£429	£635	£789	£866
LTC10CD	Circular	ø1000	£449	£655	£806	£885
	5 star base					
LTC66D	Square	600 x 600	£364	£568	£722	£799
LTC77D	Square	700 x 700	£384	£584	£736	£819
LTC88D	Square	800 x 800	£401	£606	£758	£837



Twin Pedestal Dining - 745mm High

LTC127D	Rectangular	1200 x 700	£605	£806	£962	£1,039
LTC147D	Rectangular	1400 x 700	£635	£837	£992	£1,069
LTC128D	Rectangular	1200 x 800	£610	£815	£967	£1,046
LTC148D	Rectangular	1400 x 800	£640	£842	£998	£1,079



Mid Poseur - 905mm High

LTC06CMP	Circular	ø600	£423	£626	£781	£858
LTC66MP	Square	600 x 600	£411	£615	£768	£849

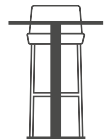

Poseur - 1125mm High

LTC06CP	Circular	ø600	£423	£626	£781	£858
LTC66P	Square	600 x 600	£411	£615	£768	£849

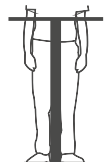

10 Year
Guarantee

LTC TABLES

Tables



- Chrome Trumpet Base design.
- Available in Circular and Square footprints.



Code	Top Shape	Top Size	Group Z 25mm MFC	Group B 36mm MFC	Group C 25mm Lam Kiko	Group D 25mm CH Lam Kiko
Coffee - 455mm High						
LTD06CR	Circular	ø600	£435	£639	£793	£871
LTD66R	Square	600 x 600	£413	£616	£769	£850
Lounge - 575mm High						
LTD06CL	Circular	ø600	£456	£660	£813	£892
LTD07CL	Circular	ø700	£474	£676	£831	£911
LTD08CL	Circular	ø800	£492	£696	£850	£928
LTD09CL	Circular	ø900	£515	£720	£871	£951
LTD10CL	Circular	ø1000	£551	£755	£910	£988
LTD66L	Square	600 x 600	£403	£608	£761	£839
LTD77L	Square	700 x 700	£448	£651	£805	£884
LTD88L	Square	800 x 800	£486	£691	£841	£921
Dining - 745mm High						
LTD06CD	Circular	ø600	£456	£660	£813	£892
LTD07CD	Circular	ø700	£474	£676	£831	£911
LTD08CD	Circular	ø800	£492	£696	£850	£928
LTD09CD	Circular	ø900	£515	£720	£871	£951
LTD10CD	Circular	ø1000	£551	£755	£910	£988
LTD66D	Square	600 x 600	£403	£608	£761	£839
LTD77D	Square	700 x 700	£448	£651	£805	£884
LTD88D	Square	800 x 800	£486	£691	£841	£921
Mid Poseur - 905mm High						
LTD06CMP	Circular	ø600	£504	£706	£860	£938
LTD66MP	Square	600 x 600	£494	£697	£853	£930
Poseur - 1125mm High						
LTD06CP	Circular	ø600	£504	£706	£860	£938
LTD66P	Square	600 x 600	£494	£697	£853	£930

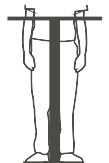
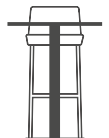
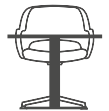

10 Year
Guarantee

LTD TABLES

Tables

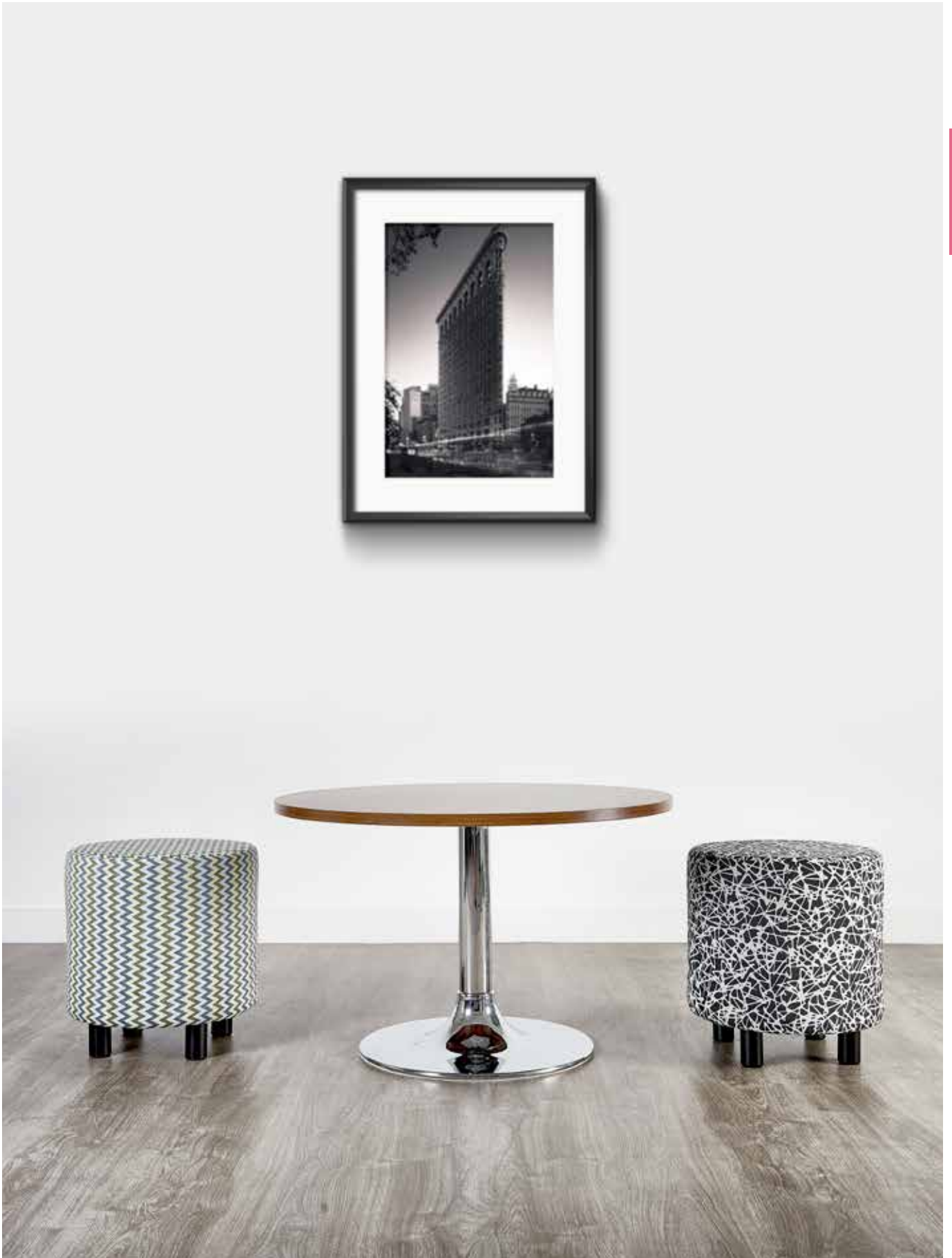

LTF BLACK TABLES



- Black Flat Base design.
- Available in Circular, Square and Rectangular footprints.



Tables

Code	Base & Top shape	Top Size	Group Z 25mm MFC	Group B 36mm MFC	Group C 25mm Lam Kiko	Group D 25mm CH Lam Kiko
Coffee - 455mm High						
LTFB06R	Circular	Ø600	£352	£553	£707	£789
LTFB66R	Square	600 x 600	£341	£546	£698	£779
Coffee Twin Pedestal - 455mm High						
LTFB127R	Rectangular	1200 x 700	£664	£867	£1,022	£1,100
LTFB147R	Rectangular	1400 x 700	£775	£979	£1,131	£1,211
LTFB128R	Rectangular	1200 x 800	£758	£963	£1,116	£1,193
LTFB148R	Rectangular	1400 x 800	£792	£996	£1,149	£1,227
Lounge - 575mm High						
LTFB06CL	Circular	Ø600	£372	£577	£731	£809
LTFB07CL	Circular	Ø700	£393	£598	£752	£829
LTFB08CL	Circular	Ø800	£410	£613	£767	£846
LTFB66L	Square	600 x 600	£365	£569	£723	£800
LTFB77L	Square	700 x 700	£385	£586	£738	£820
LTFB88L	Square	800 x 800	£401	£606	£758	£837
Lounge Twin Pedestal Base - 575mm High						
LTFB127L	Rectangular	1200 x 700	£781	£982	£1,136	£1,217
LTFB147L	Rectangular	1400 x 700	£805	£1,008	£1,161	£1,241
LTFB128L	Rectangular	1200 x 800	£790	£993	£1,146	£1,224
LTFB148L	Rectangular	1400 x 800	£815	£1,020	£1,171	£1,251
Dining - 745mm High						
LTFB06CD	Circular	Ø600	£372	£577	£731	£809
LTFB07CD	Circular	Ø700	£393	£598	£752	£829
LTFB08CD	Circular	Ø800	£410	£613	£767	£846
LTFB66D	Square	600 x 600	£365	£569	£723	£800
LTFB77D	Square	700 x 700	£385	£586	£738	£820
LTFB88D	Square	800 x 800	£401	£606	£758	£837
Dining Twin Pedestal Base - 745mm High						
LTFB127D	Rectangular	1200 x 700	£781	£982	£1,136	£1,217
LTFB147D	Rectangular	1400 x 700	£805	£1,008	£1,161	£1,241
LTFB128D	Rectangular	1200 x 800	£790	£993	£1,146	£1,224
LTFB148D	Rectangular	1400 x 800	£815	£1,020	£1,171	£1,251
Mid Poseur - 905mm High						
LTFB06CMP	Circular	Ø600	£421	£624	£776	£856
LTFB66MP	Square	600 x 600	£410	£613	£767	£846
Poseur - 1105mm High						
LTFB06CP	Circular	Ø600	£421	£624	£776	£856
LTFB66P	Square	600 x 600	£410	£613	£767	£846
Twin Pedestal Poseur - 1105mm High						
LTFB127P	Rectangular	1200 x 700	£853	£1,055	£1,207	£1,286
LTFB147P	Rectangular	1400 x 700	£877	£1,082	£1,233	£1,312
LTFB128P	Rectangular	1200 x 800	£858	£1,060	£1,217	£1,296
LTFB148P	Rectangular	1400 x 800	£887	£1,089	£1,244	£1,326

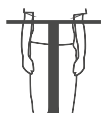
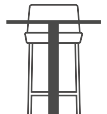
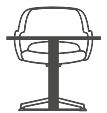

LTF BLACK TABLES

10 Year
Guarantee

Tables

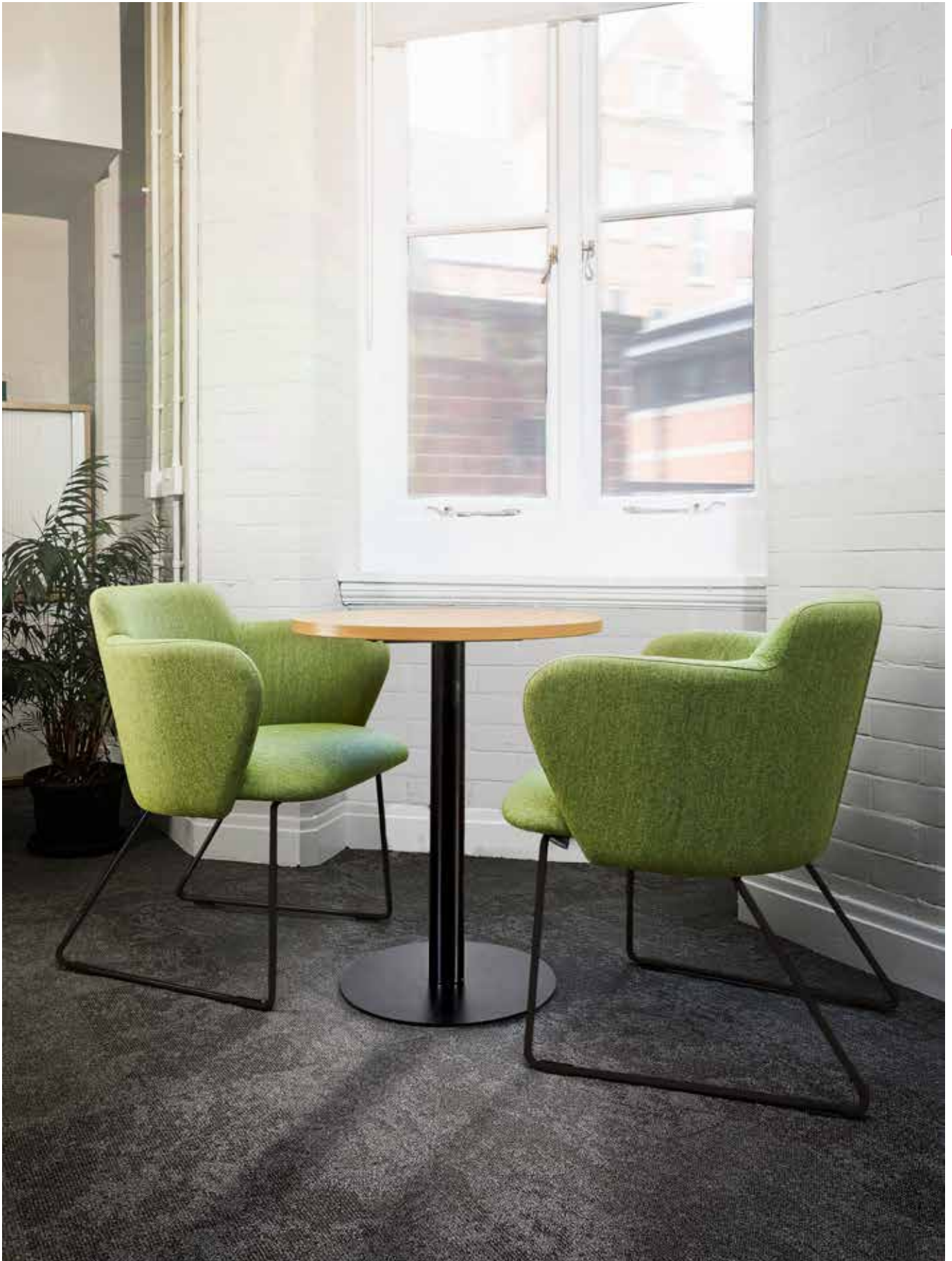

LTF STEEL TABLES

10 Year
Guarantee

- Stainless Steel Flat Base design.
- Available in Circular, Square and Rectangular footprints.

Tables

Code	Base & Top shape	Top Size	Group Z 25mm MFC	Group B 36mm MFC	Group C 25mm Lam Kiko	Group D 25mm CH Lam Kiko
Coffee - 455mm High						
LTF506R	Circular	Ø600	£574	£776	£930	£1,008
LTF566R	Square	600 x 600	£555	£761	£915	£994
Coffee Twin Pedestal - 455mm High						
LTF5127R	Rectangular	1200 x 700	£905	£1,111	£1,263	£1,341
LTF5147R	Rectangular	1400 x 700	£938	£1,144	£1,298	£1,373
LTF5128R	Rectangular	1200 x 800	£921	£974	£1,280	£1,360
LTF5148R	Rectangular	1400 x 800	£954	£1,159	£1,312	£1,391
Lounge - 575mm High						
LTF506CL	Circular	Ø600	£598	£799	£953	£1,034
LTF507CL	Circular	Ø700	£613	£819	£970	£1,051
LTF508CL	Circular	Ø800	£635	£837	£992	£1,069
LTF566L	Square	600 x 600	£586	£791	£943	£1,023
LTF577L	Square	700 x 700	£607	£809	£964	£1,041
LTF588L	Square	800 x 800	£624	£827	£980	£1,058
Lounge Twin Pedestal Base - 575mm High						
LTF5127L	Rectangular	1200 x 700	£943	£1,147	£1,301	£1,380
LTF5147L	Rectangular	1400 x 700	£970	£1,173	£1,329	£1,406
LTF5128L	Rectangular	1200 x 800	£952	£1,157	£1,310	£1,389
LTF5148L	Rectangular	1400 x 800	£979	£1,182	£1,334	£1,415
Dining - 745mm High						
LTF506CD	Circular	Ø600	£598	£799	£953	£1,034
LTF507CD	Circular	Ø700	£613	£819	£970	£1,051
LTF508CD	Circular	Ø800	£635	£837	£992	£1,069
LTF566D	Square	600 x 600	£586	£791	£943	£1,023
LTF577D	Square	700 x 700	£607	£809	£964	£1,041
LTF588D	Square	800 x 800	£624	£827	£980	£1,058
Dining Twin Pedestal Base - 745mm High						
LTF5127D	Rectangular	1200 x 700	£943	£1,147	£1,301	£1,380
LTF5147D	Rectangular	1400 x 700	£970	£1,173	£1,329	£1,406
LTF5128D	Rectangular	1200 x 800	£952	£1,157	£1,310	£1,389
LTF5148D	Rectangular	1400 x 800	£979	£1,182	£1,334	£1,415
Mid Poseur - 905mm High						
LTF506CMP	Circular	Ø600	£688	£890	£1,041	£1,121
LTF566MP	Square	600 x 600	£667	£870	£1,024	£1,102
Poseur - 1105mm High						
LTF506CP	Circular	Ø600	£688	£890	£1,041	£1,121
LTF566P	Square	600 x 600	£667	£870	£1,024	£1,102
Twin Pedestal Poseur - 1105mm High						
LTF5127P	Rectangular	1200 x 700	£1,014	£1,219	£1,371	£1,451
LTF5147P	Rectangular	1400 x 700	£1,040	£1,244	£1,397	£1,477
LTF5128P	Rectangular	1200 x 800	£1,024	£1,227	£1,381	£1,458
LTF5148P	Rectangular	1400 x 800	£1,053	£1,254	£1,409	£1,487

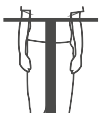
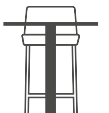
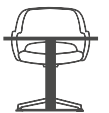

10 Year
Guarantee

LTF STEEL TABLES

Tables



RECEPTION TABLES



Tables

Code	Description	W	D	H	Group Z 25mm MFC	Group B 36mm MFC	Group C 25mm Lam Kiko	Group D 25mm CH Lam Kiko
Gallen Reception Tables Foot colours available in Natural Wood, Dark Walnut and Black Wood.								
GAL106	Soft Rectangular	1000	x 600	x 435	£545	£740	£887	£964
GAL088	Soft Square	800	x 800	x 435	£545	£740	£887	£964
GAL066	Soft Square	600	x 600	x 435	£491	£690	£836	£912
GALC08	Circular	Ø800	x	435	£595	£792	£938	£1,017
GALC06	Circular	Ø600	x	435	£541	£738	£885	£962

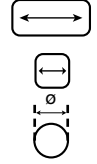

Alvier Wooden Leg Reception Table
Wooden leg available in Natural Wood and Dark Walnut.

NST069W	Soft Rectangular	980	x 680	x 275	£545	£740	£887	£964
---------	------------------	-----	-------	-------	------	------	------	------



Alvier Sled Leg Reception Table
Metalwork available in Black, Grey, Silver or White.
Surcharge for Pastel Paint - £32 per item.

NST069S	Soft Rectangular	980	x 680	x 275	£545	£740	£887	£964
---------	------------------	-----	-------	-------	------	------	------	------



Adore Reception Table with Rod Frame
Metalwork available in Black, Grey, Silver or White.
Surcharge for Pastel Paint - £32 per item.

AD66	Soft Square	600	x 600	x 275	£410	£609	£754	£829
AD06	Circular	Ø600	x	450	£410	£609	£754	£829
AD6645	Soft Square	600	x 600	x 450	£410	£609	£754	£829

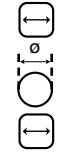

Gallen

Alvier Wooden Leg

Alvier Sled Leg

Adore



Code	Description	W	D	Price
------	-------------	---	---	-------

EX10 Panel End Reception Tables - 400mm High
25mm MFC

KNPTRR10	Rectangular	100	x 600	£347
KNPTRR6	Square	600	x 600	£273
KNDPTRL	Lozenge	1000	x 600	£409
KNPTRC8	Circular		ø800	£422
KNPTRC	Circular		ø600	£301



Code	Description	Price
HAT	Hat & coat stand	£78
HATU	Hat & Coat stand with umbrella ring	£102



HATU

10 Year
Guarantee

RECEPTION TABLES

Tables



Adore Circular Reception Table

VONA TABLES

10 Year
Guarantee

Vona table was developed to complement the Vona chair. With its sleek rod frame design and 100% recyclability, it's the perfect match.

- Available with circular and square top panels.
- 25mm MFC top panels
- Optional central port hole (suit power modules)



When specifying Cable Ports - suffix the table code with code P

Tables

Code	Description	Dimensions	MFC Price
Vona Table			
LS3410CD	Circular	1000ø x 727H	£320
LS341010S	Square	1000 x 1000 x 727H	£341



LS3410CD

10 Year
Guarantee

GD3 TABLES

GD3 Table was developed to complement the GD3 Stools. With its sleek rod frame design and 100% recyclability, it's the perfect match.

- Available with circular and square top panels.
- 25mm MFC top panels
- Optional central port hole (suit power modules)



When specifying Cable Ports -
suffix the table code with code P

Code	Description	Dimensions	MFC Price
GD3 Table			
GD3T10CD	Circular	1000ø x 727H	£305
GD3T1010S	Square	1000 x 1000 x 727H	£324



Tables



GD3T10CD

GD27 TABLES



An industrial inspired table with a square steel tube frame.

Available in two footprints and two heights to use as a contemporary sofa end table or sleek coffee table in any living or commercial space.



Tables

Code	Description	W	L	H	18mm MFC	
Side Table						
GD27A1	Square Single Table	450	x 450	x 455	£544	
GD27B1	Square Single Table	450	x 450	x 575	£544	
GD27A2	Rectangular Single Table	450	x 915	x 455	£947	
GD27B2	Rectangular Single Table	450	x 915	x 575	£947	
GD27A3	Rectangular Twin Table	450	x 885	x 455	£947	
GD27B3	Rectangular Twin Table	450	x 885	x 575	£947	



Square Single Table



Rectangular Single Table



Rectangular Twin Table



GD27 Side Table MFC

Included are a selection of multi-purpose products that can be used in every-day applications.

Items are available in a variety of finishes allowing them to be used individually or suited with other products.



Code Description W D Price

Laptop Table 18mm Lacquered MDF Top Panel
Metalwork only available in Black, White or Silver
Top Panels available in Black or White

LAPHAM 625/1050h 520 x 380 £506
height adjustable



Laptop Tables 25mm MFC Top Panels
Metalwork only available in Black, White or Silver

LAPHA 625/1050h 400 x 350 £476
height adjustable



Code Description W D MFC Price

Telephone / Fax Tables

FT80Z 800 x 450 £217
FT60Z 600 x 450 £180



Code Description W D MFC Price

Folding Exam Table

ETF86Z 860 x 500 £187



Exam Table

ET86Z Top Dimensions 765 x 504 £151
Overall Dimensions 860 x 504

Folding Exam Table Trolley

ETFT To suit 25x folding exam tables 1650 x 930 £553



Code Description W D H Price

Glass Clear Top

Conical legs available in Black or Chrome.

GLAS9S Rectangular 950 x 500 x 350 £365
GLAS5S Square 500 x 500 x 350 £284

Code Description W D H Price

Glass Frosted Top

Conical legs available in Black or Chrome.

GLAS9F Rectangular 950 x 500 x 350 £468
GLAS5F Square 500 x 500 x 350 £324
GLAS6F Circular Ø500 x 350 £486



GLASS Reception Table

RELO TABLES



A continuation of calm: Gresham introduces its new Relo table range. Crafted to seamlessly complement Gresham's Relo collection of rounded chairs, the new Relo table range supports designers in creating comforting, calming schemes. Mirroring the unmistakable curves of Relo, the tables offer a visual link back to their aesthetic inspiration; that of sea-smoothed pebbles and stones emerging from turbulent waters. Available in 9 variations, versatility is offered as standard. From larger, two-tiered designs to smaller options, there's a combination to suit all contemporary spaces. The circular tabletop is created from MFC (Melamine Faced Chipboard), and the statement 20mm geometric steel frames can be chosen in Black, White, Grey or Silver.

Available Frame Colours

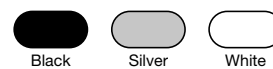

Tables



RELTA1
Small Low Circular Table



RELTA2
Small High Circular Table



RELTB1
Large Circular Table



RELTB2
Large Circular Table with Shelf





RELO TABLES

Code	Description	Width	Depth	Height	MFC
RELTA1	Small Low Circular Table	Ø495	x	455	£232
RELTA2	Small High Circular Table	Ø495	x	575	£238
RELTB1	Large Circular Table	Ø740	x	455	£276
RELTB2	Large Circular Table with Shelf	Ø740	x	455	£327
RELTC1	Low Cylindrical Table	1240	x 500	x 455	£353
RELTC2	High Cylindrical Table	1240	x 500	x 575	£360
RELTC3	High Cylindrical Table with Shelf	1240	x 500	x 575	£421
RELTD1	Low Cylindrical Table with Circular Shelf	1240	x 500	x 455/570	£483
RELTD2	High Cylindrical Table with Circular Shelf	1240	x 500	x 575/690	£488



RELTC1
Low Cylindrical Table



RELTC2
High Cylindrical Table



RELTC3
High Cylindrical Table with Shelf



RELTD1
Low Cylindrical Table with Circular Shelf



RELTD2
High Cylindrical Table with Circular Shelf



INTRODUCTION

SCREENS & PODS

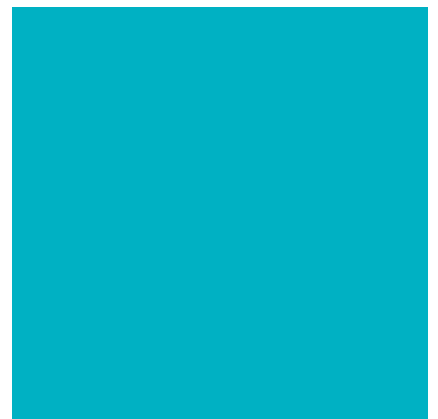
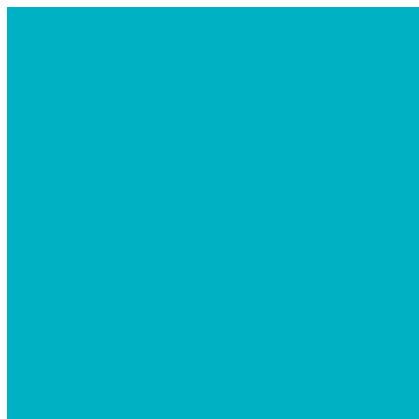
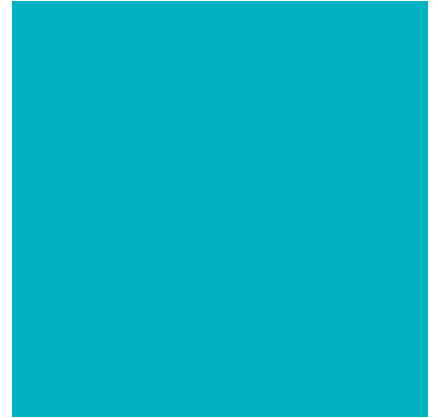
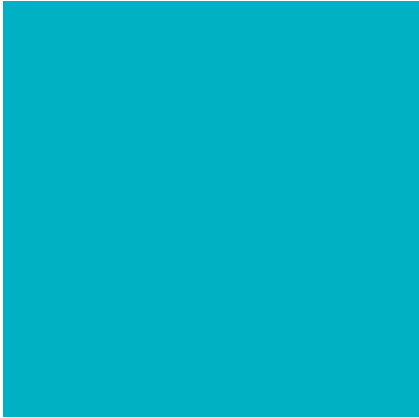
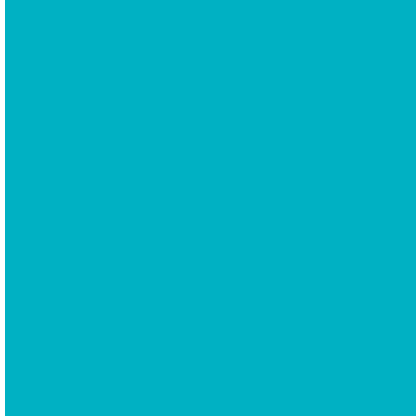

INTRODUCTION SCREENS & PODS



For board finishes please see Technical Information section.



For GOF Screen fabrics please see Technical Information section (Guarantees shown exclude upholstery).



For GOF Screen Acrylics please see Technical Information section.



GOF Screen accessories available.

Screens & Pods

GOF SCREEN COLOURED FROSTED ACRYLICS (SURCHARGE)

				
S2 9T21 Stone Grey	S2 4T50 Chilli Red	S2 2T07 Citrus Yellow	S2 7T28 Sapphire Blue	S2 3T17 Mandarin Orange
				
S2 6T21 Glacier Green	S2 7T77 Arctic Blue	S2 4T46 Blush Pink	S2 7T58 Aurora Violet	S2 6T9A Lime Zest
				
S2 7T1F Azure Blue	S2 7T69 Electric Blue	S2 9221 Midnight Black		

GOF & MESA PLUS SCREEN FABRICS

Band 1 Camira Cara Camira Carlow Camira Lucia Camira Sonus Inloom Bondai 170	Band 2 Camira Lucia CS	Band 3 Camira Blazer Lite Camira Nexus
--	----------------------------------	---

GOF SCREEN ACRYLICS

PERSPEX



S2 000
Clear

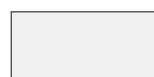

S2 030
Polar Frost

KULTURE HABITAT SCREENS & PODS



Thoroughly fit for the contemporary workplace, our Kulture Habitat Pods respond directly to the needs of both employees and employers. Providing an adaptable space that can facilitate quiet 'heads down' tasks, small-scale collaboration, or group meetings, this is a beautifully efficient solution that can be made to fit all. Personalise your Pod by choosing from a range of bespoke options, from single or half glazed and upholstered walls, to a canopy fitted with stylish, sound absorbent PET panels, and a booth with integrated table - there's a combination to suit every scheme.

Please Note: The Canopy and Booth are not available as standalone products. They must be used in conjunction with Kulture Habitat Glazed Pods.

Product Features



Available Frame Colours



Please Note: Prices do not include installation which is mandatory by Gresham qualified installers. Installation costs will be an additional charge and will be supplied on completion of a Gresham consultation or site survey form.

Screens & Pods

Kulture Habitat Fabric Options

Fabric Band A			
Camira Cara	EN 1021 / BS 476 P7 -	100% Polypropylene	x
Camira Carlow	C&M -	100% Polypropylene	x
Camira Citadel	C&M 30,000	100% FR Polypropylene	
Camira Gravity	C&M 80,000	76% Polyester, 24% Recycled Polyester	
Camira Rivet	C&M 80000	100% Recycled Polyester	
Inloom Erika	C&M 70,000	100% Polyester	
Fabric Band B			
Camira Aspect	CRIB 5 50,000	75% Trevira CS FR Polyester, 25% Polyester	
Camira Blazer	C&M 50,000	100% Virgin Wool	
Camira Blazer Lite	BS 476 -	100% Virgin Wool	x
Camira Patina	CRIB 5 100,000	69% Wool, 22% Flax, 8% Polyamide, 1% Viscose	
Camira Synergy 170	C&M 100,000	95% Virgin Wool, 5% Polyamide	x
Camira Synergy	C&M 100,000	95% Virgin Wool, 5% Polyamide	
Camira X2	CRIB 5 100,000	100% Recycled FR Polyester	
Inloom One	C&M 100,000	100% Recycled FR Polyester	
Inloom Jet Bioactive	CRIB 5	100% Polyester	
Inloom Roccia	CRIB5	100% Polyester	
Agua Buro	CRIB 5	100% Treated Polyester	

x - Denotes seating is not available in this fabric





KULTURE HABITAT SCREENS & PODS



Screens & Pods

Kulture Habitat PET Colour Options



Single Glazed Pods

Strong in both form and function, our Single Glazed Habitat Pod comprises a seamless meeting room solution - offering a quiet corner away from the hustle and bustle of the main workspace for calls, chats, and head's down work.

Standard Features

- Acoustically tested to BSEN ISO 140 and rated at 36dB noise reduction.
- 55mm sound absorbing upholstered panels.
- 22mm double glazed glass panels with stripe manifestations.
- 8mm glass door with stripe manifestations.
- 52mm sound absorbing ceiling panels upholstered in light grey.
- Integrated ceiling cover included as standard.
- Integrated facilities arch included as standard housing lighting system.
- PIR operated, high output - low voltage, diffused dual LED strip lighting included as standard.

Options

- Air circulation fan available with 216m³/h airflow.
- Flush mounted modules available with power, charge, data, HDMI & VGA
- Alternative widths and depths available on request.
- Alternative panel finishes available on request.



KHP2020WG
2 Person Pod
2000w x 2000d



KHP2520WG
2 Person Pod
2500w x 2000d



KHP3020WG
3 Person Pod
3000w x 2000d



KHP3520WG
3 Person Pod
3500w x 2000d



KHP2024WG
2 Person Pod
2000w x 2400d



KHP2524WG
2 Person Pod
2500w x 2400d



KHP3024WG
3 Person Pod
3000w x 2400d



KHP3524WG
3 Person Pod
3500w x 2400d

Single Glazed Pods

Model	Dimensions (mm)	Height (mm)	Suitable for	Suitable Table	Band A	Band B
KHP2020WG	2000w x 2000d	2200	2 People	800mm Dia.	£21,086	£23,354
KHP2520WG	2500w x 2000d	2200	2 People	800mm Dia.	£22,874	£25,181
KHP3020WG	3000w x 2000d	2200	3 People	800mm Dia.	£24,748	£27,394
KHP3520WG	3500w x 2000d	2200	3 People	800mm Dia.	£26,409	£29,078
KHP2024WG	2000w x 2400d	2200	2 People	800mm Dia.	£21,541	£23,809
KHP2524WG	2500w x 2400d	2200	2 People	800mm Dia.	£23,394	£25,701
KHP3024WG	3000w x 2400d	2200	3 People	800mm Dia.	£25,285	£27,930
KHP3524WG	3500w x 2400d	2200	3 People	800mm Dia.	£27,356	£30,032



Half Glazed Pods

Extending the design possibilities of our Habitat Pods is the Half Glazed range, which allows natural light to flow into the space from both sides. When incorporated into a workplace scheme, it efficiently, and beautifully, promotes privacy.

Optional Extras

Air circulation fan	£1,679
Flush 1x UK Power Socket	£777
Flush 2x UK Power Sockets	£827
Flush 1x TUF Socket (1x USB & 1x USB-C)	£1,095
TV/Monitor Mount Bracket (32"-50")	£1,174
Sliding Door Lock	£1,798
Slow Door Close System	£542
Dimmable Remote Control	£877



Screens & Pods



KHP2020HG
2 Person Pod
2000w x 2000d



KHP2520HG
2 Person Pod
2500w x 2000d



KHP3020HG
3 Person Pod
3000w x 2000d



KHP3520HG
3 Person Pod
3500w x 2000d



KHP2024HG
2 Person Pod
2000w x 2400d



KHP2524HG
2 Person Pod
2500w x 2400d



KHP3024HG
3 Person Pod
3000w x 2400d



KHP3524HG
3 Person Pod
3500w x 2400d

Half Glazed Pods

Model	Dimensions (mm)	Height (mm)	Suitable for	Suitable Table	Band A	Band B
KHP2020HG	2000w x 2000d	2200	2 People	800mm Dia.	£21,909	£23,427
KHP2520HG	2500w x 2000d	2200	2 People	800mm Dia.	£24,340	£25,896
KHP3020HG	3000w x 2000d	2200	3 People	800mm Dia.	£26,081	£27,593
KHP3520HG	3500w x 2000d	2200	3 People	800mm Dia.	£27,240	£29,512
KHP2024HG	2000w x 2400d	2200	2 People	800mm Dia.	£22,367	£23,837
KHP2524HG	2500w x 2400d	2200	2 People	800mm Dia.	£24,860	£26,416
KHP3024HG	3000w x 2400d	2200	3 People	800mm Dia.	£26,495	£28,013
KHP3524HG	3500w x 2400d	2200	3 People	800mm Dia.	£29,294	£30,832

KULTURE HABITAT SCREENS & PODS

NEW
PRODUCT

5 Year
Guarantee

Canopy Pods

Limited space doesn't have to mean compromise. Our Canopy range allows a portion of the office to be separated for collaborative work, facilitating privacy and minimising disturbance to those situated close-by.

Standard Features

- Add-On Open Canopy with stylish PET panels, a material manufactured from recycled sources and has a great environmental story.
- PET is naturally sound absorbing so whilst refreshing an office environment you can help reduce reverberation at the same time.
- 12mm thick PET acoustically tested to ASTM C423-17 with NRC 0.80
- PET panels available in a variety of colours.



Screens & Pods



KHC1820
4 Person Pod
1800w x 2000d



KHC2320
4 Person Pod
2300w x 2000d



KHC1824
4 Person Pod
1800w x 2400d



KHC2324
4 Person Pod
2300w x 2400d

Canopy Pods

Model	Dimensions (mm)	Height (mm)	Suitable for	Suitable Table	Price
KHC1820	1800w x 2000d	2200	4 People	1200mm x 800mm	£8,339
KHC2320	2300w x 2000d	2200	4 People	1400mm x 800mm	£8,494
KHC1824	1800w x 2400d	2200	4 People	1200mm x 800mm	£8,447
KHC2324	2300w x 2400d	2200	4 People	1400mm x 800mm	£8,603



KULTURE HABITAT SCREENS & PODS

Booth Pods

Providing an informal space for collaboration, our Booths, with integrated seating and table, offer a comfortable, semi-enclosed area for one-on-one discussions, small group meetings and the completion of solo tasks.

Standard Features

- Add-On seating booth with integrated table.
- Table at 727mm high with single post support leg.
- Post mounted brushed steel task light included.

Optional Extras

Flush 1x UK Power Socket	£777
Flush 2x UK Power Sockets.....	£827
Flush 1x TUF Socket (1x USB & 1x USB-C).....	£1,095
TV/Monitor Mount Bracket (32"-50").....	£1,174



Screens & Pods



KHB0820
2 Person Pod
800w x 2000d



KHB1220
4 Person Pod
1200w x 2000d



KHB1620
4-6 Person Pod
1600w x 2000d



KHB0824
2 Person Pod
800w x 2400d



KHB1224
4 Person Pod
1200w x 2400d



KHB1624
4-6 Person Pod
1600w x 2400d

Booth Pods

Model	Dimensions (mm)	Height (mm)	Suitable for	Supplied Table	Band A	Band B
KHB0820	800w x 2000d	2200	2 People	800mm x 750mm	£8,760	£10,382
KHB1220	1200w x 2000d	2200	4 People	1200mm x 750mm	£10,693	£12,310
KHB1620	1600w x 2000d	2200	4-6 People	1600mm x 750mm	£15,005	£16,936
KHB0824	800w x 2400d	2200	2 People	800mm x 1000mm	£8,805	£10,336
KHB1224	1200w x 2400d	2200	4 People	1200mm x 1000mm	£10,791	£12,217
KHB1624	1600w x 2400d	2200	4-6 People	1600mm x 1000mm	£15,084	£16,858

MIRAGE HUTCH SCREENS & PODS



Designed in response to the needs of the contemporary workplace, our Mirage Hutch range not only offers functionality, but comprises a stylish office focal point, too. Available as either a two, four or six-seater pod, with a flat or pitched roof, this unique product can be customised to suit any space, and all interior styles. Choose to upholster your pod in one single shade of fabric, or pair two complementary or contrasting tones to create all-out statement.

Product Features



Available Frame Colours



Available Wood Finishes



Screens & Pods



MCON02PS
2 Person Pod
Pitched Roof & LED Spotlight



MCON02PP
2 Person Pod
Pitched Roof & Pendant Light



MCON04PS
4 Person Pod
Pitched Roof & LED Spotlight



MCON04PP
4 Person Pod
Pitched Roof & Pendant Light



MCON06PS
6 Person Pod
Pitched Roof & LED Spotlight



MCON06PP
6 Person Pod
Pitched Roof & Pendant Light



MCON01FS
1 Person Pod
Flat Roof & LED Spotlight



MCON02FS
2 Person Pod
Flat Roof & LED Spotlight



MCON02FP
2 Person Pod
Flat Roof & Pendant Light



MCON04FS
4 Person Pod
Flat Roof & LED Spotlight



MCON04FP
4 Person Pod
Flat Roof & Pendant Light



MCON06FS
6 Person Pod
Flat Roof & LED Spotlight



MCON06FP
6 Person Pod
Flat Roof & Pendant Light

Model	Roof Style	Dimensions (mm)	Height (mm)	Suitable for	Lighting	Band A	Band B
MCON02PS	Pitched Roof	2000w x 800d	2100	2 People	LED Spotlight	£16,207	£17,672
MCON02PP	Pitched Roof	2000w x 800d	2100	2 People	Pendant Light	£16,207	£17,672
MCON04PS	Pitched Roof	2000w x 1200d	2100	4 People	LED Spotlight	£19,559	£21,099
MCON04PP	Pitched Roof	2000w x 1200d	2100	4 People	Pendant Light	£19,559	£21,099
MCON06PS	Pitched Roof	2000w x 1900d	2100	6 People	LED Spotlight	£23,493	£24,958
MCON06PP	Pitched Roof	2000w x 1900d	2100	6 People	Pendant Light	£23,493	£24,958
MCON01FS	Flat Roof	1100w x 800d	2100	1 People	LED Spotlight	£12,670	£13,574
MCON02FS	Flat Roof	2000w x 800d	2100	2 People	LED Spotlight	£16,207	£17,672
MCON02FP	Flat Roof	2000w x 800d	2100	2 People	Pendant Light	£16,207	£17,672
MCON04FS	Flat Roof	2000w x 1200d	2100	4 People	LED Spotlight	£19,559	£21,099
MCON04FP	Flat Roof	2000w x 1200d	2100	4 People	Pendant Light	£19,559	£21,099
MCON06FS	Flat Roof	2000w x 1900d	2100	6 People	LED Spotlight	£23,493	£24,958
MCON06FP	Flat Roof	2000w x 1900d	2100	6 People	Pendant Light	£23,493	£24,958



MIRAGE HUTCH SCREENS & PODS

Mirage Hutch Fabric Options

Fabric Band A	
Camira Carlow	C&M - 100% Polypropylene x
Camira Citadel	C&M 30,000 100% FR Polypropylene
Camira Gravity	C&M 80,000 76% Polyester, 24% Recycled Polyester
Camira Rivet	C&M 80000 100% Recycled Polyester
Fabric Band B	
Camira Aspect	CRIB 5 50,000 75% Trevira CS FR Polyester, 25% Polyester
Camira Blazer	C&M 50,000 100% Virgin Wool
Camira Blazer Lite	BS 476 - 100% Virgin Wool x
Camira Oceanic	BS 7176 100,000 100% Recycled Polyester including 50% SEAQUAL yarn
Camira Patina	CRIB 5 100,000 69% Wool, 22% Flax, 8% Polyamide, 1% Viscose
Camira Synergy 170	C&M 100,000 95% Virgin Wool, 5% Polyamide x
Camira Synergy	C&M 100,000 95% Virgin Wool, 5% Polyamide
Camira X2	CRIB 5 100,000 100% Recycled FR Polyester
Inloom Jet Bioactive	CRIB 5 100% Polyester
Inloom Roccia	CRIB5 100% Polyester
Agua Buro	CRIB 5 100% Treated Polyester

x - Denotes seating is not available in this fabric



Oak Wood - Seats: Camira Synergy Intertwine LDS42 / Walls: Camira Synergy Summon LDS45 (Shown without Vertical Channel - POA)

MIRAGE PODS & GE MOBILE

Mirage Pod & GE Mobile fabrics differ from our standard fabric bands. Fabrics for these products have a laminated foam backing that increases sound absorbency. A number of fabric selections for Mirage Pods and GE Mobile are available as shown.

Mirage Pods & GE Mobile can have different tiered levels in alternative fabrics as illustrated below. If all the chosen fabrics are all from the same selection, then please choose the relevant fabric selection price. If the chosen fabrics are a mixture of selections, then choose the highest relevant fabric selection price.

Other fabrics may be available on request - POA. Fabrics not shown in Selections 1-4 may be subject to testing.

Screens & Pods

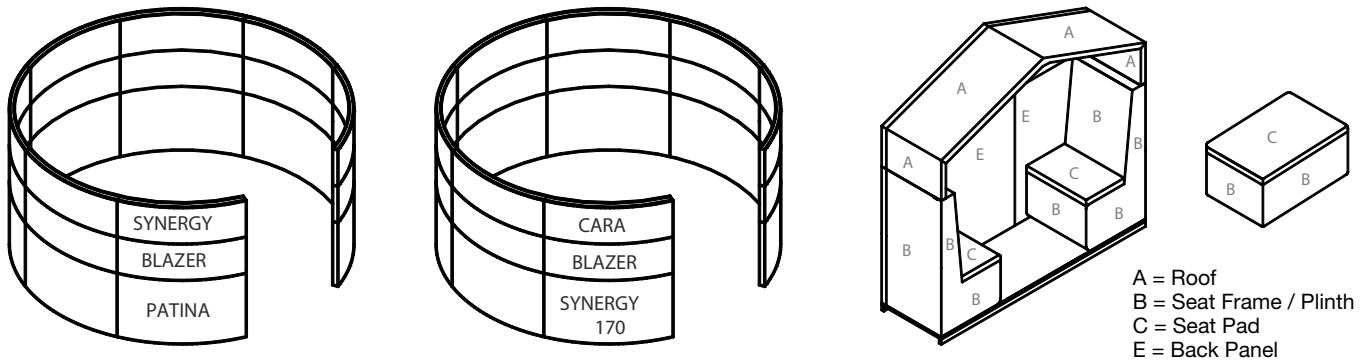

Example:
Fabrics from same selection
(Fabric Selection 4 Price)

Example:
Mixture of fabrics from different selections
(Fabric Selection 3 Price - Highest)

MIRAGE LITE/TACKABLE & GE6

Due to manufacturing processes Mirage Lite & GE6 fabric options differ from our standard screen fabric bands and the available fabrics are shown in their relevant section of the Product Guide. Prices shown are for single colour fabrics only. Tackable versions of Mirage Lite are available for a £87 surcharge.

Other fabrics may be available on request - POA. Mirage Lite Acoustic desk top screens are also available on request – POA.

5 Year
Guarantee

MIRAGE PODS SCREENS & PODS

Screens & Pods



Mirage Colorado Semi Circular Pod

MIRAGE PODS

Workspace design has evolved over the decades to meet the changing demands of the workplace and the needs of the people who work in them.

Today, the very best contemporary workspaces are designed to provide not only functional efficiency, but be responsive to the needs of employees in terms of enhancing productivity and promoting personal wellbeing. Smart lateral thinking is required to create a multi-purpose environment that successfully achieves these goals, all within one singular space.

Able to transform a chaotic open plan spaces into an oasis of calm, where zones designed for privacy, for collaborative work, and for core activities function together seamlessly, the Mirage family of pods are the product of such thinking.

Mirage uses high quality materials to create aesthetically pleasing modular pods for employees to work in. Their carefully crafted panels and coloured trim reflects the purpose of each pod and how it will be used. Subtle, tranquil hues enhance quiet contemplation, for example, while bright, vibrant shades help to create a stimulating workspace that facilitates increased creativity and productivity.

As well as helping you to reorganise your office in order to make best use of existing floorspace, Mirage Pods also help to provide noise control for energetic working environments. Slimline panels can reduce noise levels by up to 30 decibels, meaning that private spaces remain private, while the acoustics in shared spaces promote great communication.



5 Year
Guarantee

MIRAGE PODS SCREENS & PODS



MIRAGE PODS

SCREENS & PODS

5 Year
Guarantee

GOBI STUDY POD

Single occupancy Gobi pods provide quiet work areas that allow users to focus on specific tasks in an environment that minimises distractions caused by external noise. These pods are cosy, ergonomically designed, and perfectly suited for their purpose. You have the option of selecting modules equipped for either permanently based equipment or mobile devices, or both, depending on your requirements. The most popular Gobi pods are of a two-tier height that works to create a protective cocoon around seated users. When standing, users are able to get a clear view of surrounding open plan areas. Gobi individual pods have a relatively small footprint, making them easy to place, and are also available in a slightly taller version, shaped like a phone booth, which has a roof plus perch points for users. These taller pods also have a useful integral light that is activated as the user approaches the booth.



Screens & Pods



SONORAN WORK POD

Sonoran pods are designed to provide private, separate workspaces that can be clustered together in different configurations. They are ideal for housing team members or workers who benefit from being geographically close together but who still want to occupy an individual unit. The integral work surfaces are generally straight rather than curved, giving the pods a streamlined appearance. You also have the option of adding service modules and cabling as required for permanently installed equipment, as well as for mobile devices. Configuring your Sonoran pods couldn't be easier. Select single-sided pods allow users to share walls or opt for a back-to-back layout if preferred. When clustered, these pods make the most of existing floor space, allowing you to provide workspace for a greater number of people per square metre. Sonoran pods are extremely efficient and cost effective, requiring few components.



MIRAGE PODS SCREENS & PODS



ATACAMA STUDY POD

If your workplace requires pod clusters that can function like hot desk stations, Atacama pods with shared components provide an ideal solution. Each pod has a triangular shape, which allows for the creation of a zigzag footprint when clustered with other Atacama pods, with each user being placed in the resultant zigzag corner. Work surfaces are designed to allow cabling to pass neatly through a cut-out space, and configured so that its possible to mount flat screen monitors or place desk top service modules within easy reach of occupants. With smaller work surfaces than Sonoran pods, people are less likely to clutter up the tapered space with personal effects. Atacama is the ideal pod for workers who need everything to hand when they drop in for a short period of time before moving on. This is a highly efficient solution that maximises available space for a mobile workforce.



Screens & Pods



SAHARA MEETING POD

Shared workspaces need to be carefully structured to make the most of the available space, as well as enhance the type of activity taking place within them. Sahara pods are designed to create a multiple occupancy workspace that facilitates collaborative work in a quiet environment. Thanks to its acoustic dampening function, whether you want to create a quiet collaborative working space, free from distractions within an open plan area, or a room in which lively discussion can be contained, Sahara pods can do both. The flexibility of the Sahara system means you can choose from a range of larger pods with options for the number of tiers required. Single tiers can be used to delineate space, while units with additional tiers allow for increased privacy. To create shared service areas for printers and photocopiers, simply use Sahara to encircle equipment and deaden the sound.



MIRAGE PODS SCREENS & PODS



COLORADO MEETING POD

Colorado pods have gently curved walls, and are therefore ideal for creating layouts that are less angular and more fluid by design. Use of such aesthetics softens interior spaces, making them perfect environments for use as informal break-out areas, or as comfortable rooms in which to hold formal meetings and conference activities. As with Sahara pods, additional tiers can be added to Colorado units for privacy purposes, and there is also the option to choose whether you'd like the pod to have one or two entry points. This might depend, for example, on the level of access you need, as well as on what type of activities you plan for the pod. Furniture options include soft seating, suitable for informal activities, and dining or meeting and conference furniture for more formal events. You can structure Colorado pods exactly as you wish for specific activities, such as staff training sessions or briefings.



Screens & Pods



KARAKUM MEETING POD

The Karakum range offers the perfect solution for housing small, private groups. The pod walls are three tiers high, above which can be found an integral roof. Pods suitable for occupancy by two, four or six occupants are available, in-line with your needs, as are units that include efficient LED lighting. Sensors for the lighting are triggered when Karakum is occupied, and will switch off when the pods are empty, ensuring optimal energy efficiency. Despite having a roof,

the Karakum pod is designed to promote clean air circulation, helping users to stay focused and motivated. Selecting furniture from the options available will allow you to determine how the pod is to be used. Services can be routed from the floor upwards via the walls, as is the case with all Mirage pods, to feed adjacent or fixed work surfaces as well as suspended equipment such as monitors and projectors.



MIRAGE PODS SCREENS & PODS

5 Year
Guarantee

Screens & Pods

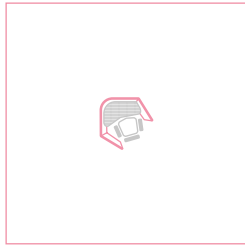

MP20R-12
Single User Right Hand
Study Pod

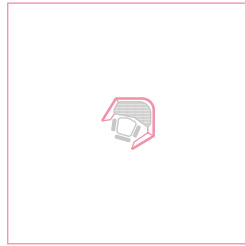

MP20L-12
Single User Left Hand
Study Pod

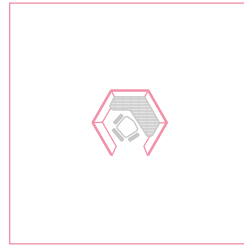

MP21R-18
Single User Right Hand
Study Pod

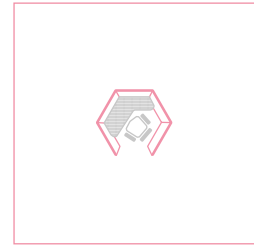

MP21L-18
Single User Left Hand
Study Pod

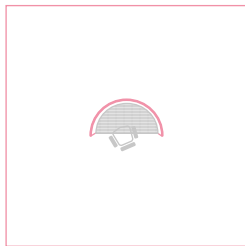

MP23-17
Single User
Study Pod

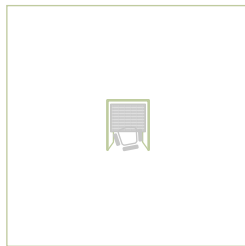

MP1-10
Small Single User
Work Pod

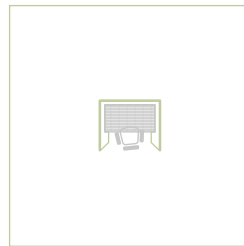

MP1-14
Large Single User
Work Pod

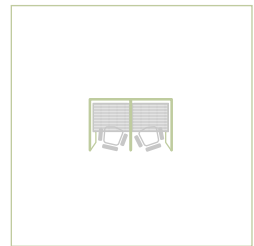

MP3-10
Small 2 User
Work Pod

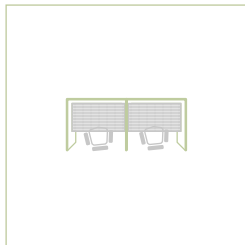

MP3-14
Large 2 User
Work Pod

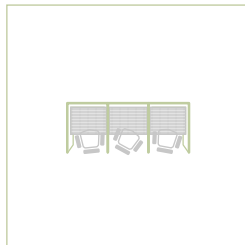

MP5-10
Small 3 User
Work Pod

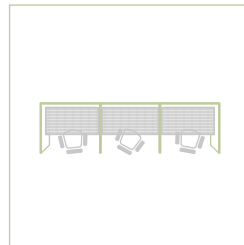

MP5-14
Large 3 User
Work Pod

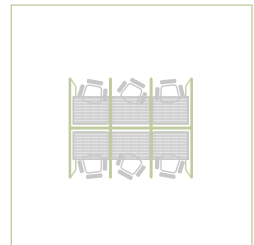

MP6-10
Small 6 Facing User
Work Pod

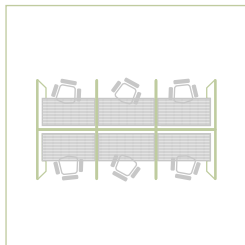

MP6-14
Large 6 Facing User
Work Pod

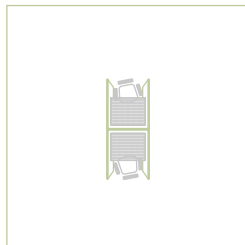

MP2-10
Small 2 Facing User
Work Pod

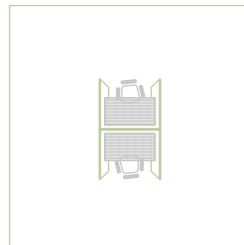

MP2-14
Large 2 Facing User
Work Pod

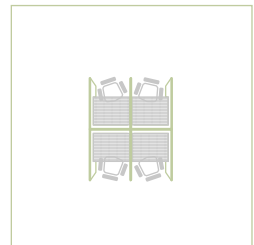

MP4-10
Small 4 Facing User
Work Pod

Key:

- Gobi
- Sahara
- Sonoran
- Colorado
- Atacama
- Karakum

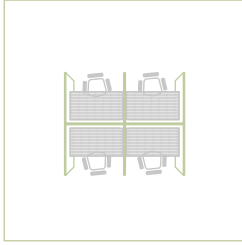

MP4-14
Large 4 Facing User
Work Pod

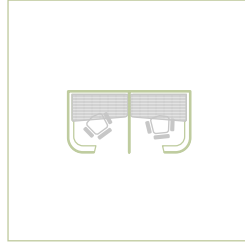

MP14-29
2 User
Work Pod

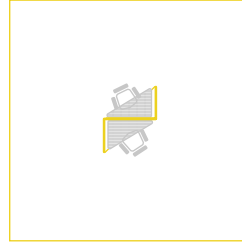

MP7L-12
2 User Left Hand
Zig Zag Study Pod

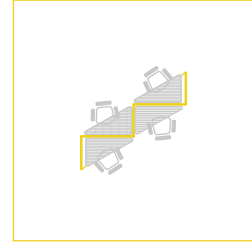

MP7L-23
4 User Left Hand
Zig Zag Study Pod

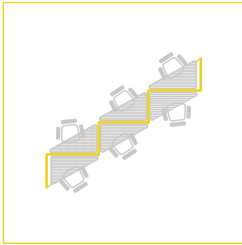

MP7L-32
6 User Left Hand
Zig Zag Study Pod

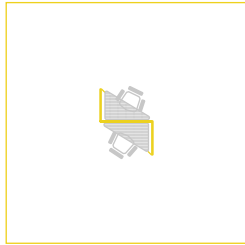

MP7R-12
2 User Right Hand
Zig Zag Study Pod

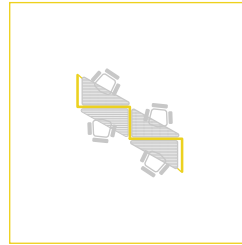

MP7R-23
4 User Right Hand
Zig Zag Study Pod

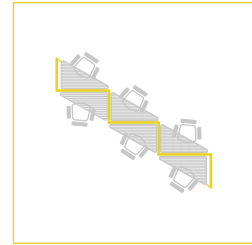

MP7R-32
6 User Right Hand
Zig Zag Study Pod

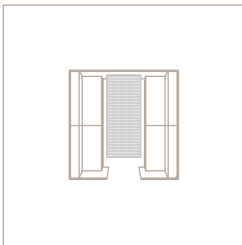

MP11-25
Single Entry Square
Meeting Pod

Fits: 4x LS24B1 2 Seater Sofas
and up to 2000w x 800d Dining
Height Table (Not Supplied)

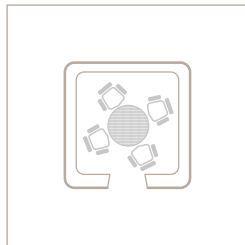

MP10-30
Single Entry Square
Meeting Pod

Fits: 1000Ø Table and 4 Chairs
(Not Supplied)

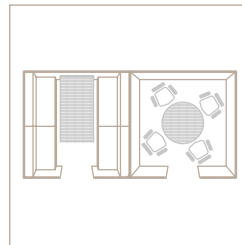

MP12-50
Twin Entry Rectangular
Meeting Pod

Fits: 4x LS24B1 2 Seater Sofas
and up to 2000w x 800d Dining
Height Table and 1000Ø Table
and 4 Chairs (Not Supplied)

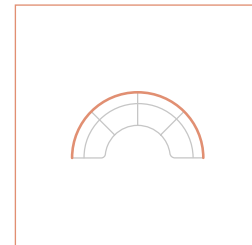

MP28-30
Semi-Circular
Meeting Pod

Fits: 4x LS24D1 Small Curved
Seater Sofas (Not Supplied)

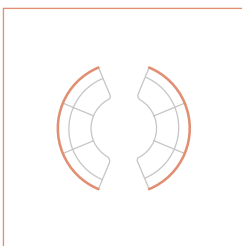

MP25-30
Twin Entry Circular
Meeting Pod

Fits: 6x LS24D1 Small Curved
Seater Sofas (Not Supplied)

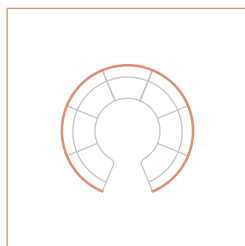

MP26-30
Single Entry Circular
Meeting Pod

Fits: 7x LS24D1 Small Curved
Seater Sofas (Not Supplied)

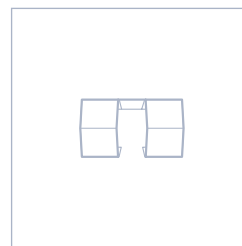

MP17-13
4 User Meeting Pod
with Angled Roofs

Fits: 2x LS24B1 2 Seater Sofas
and up to 1000w x 800d Dining
Height Table (Not Supplied)

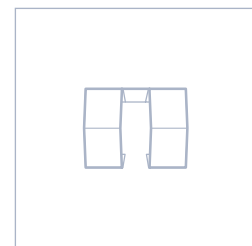

MP17-18
6 User Meeting Pod
with Angled Roofs

Fits: 2x LS24C1 3 Seater Sofas
and up to 1400w x 800d Dining
Height Table (Not Supplied)

MIRAGE POD & GE MOBILE FABRIC SELECTIONS

Fabric Selection 1 Camira Cara Camira Carlow	Fabric Selection 2 Camira Blazer Lite Inloom One	Fabric Selection 3 Camira Synergy 170 Camira Advantage	Fabric Selection 4 Camira Aspect Camira Blazer Camira Patina Camira Synergy Camira X2 Agua Buro Camira Canopy Camira Quest Agua Buro
---	---	---	--

WALL DIMENSIONS

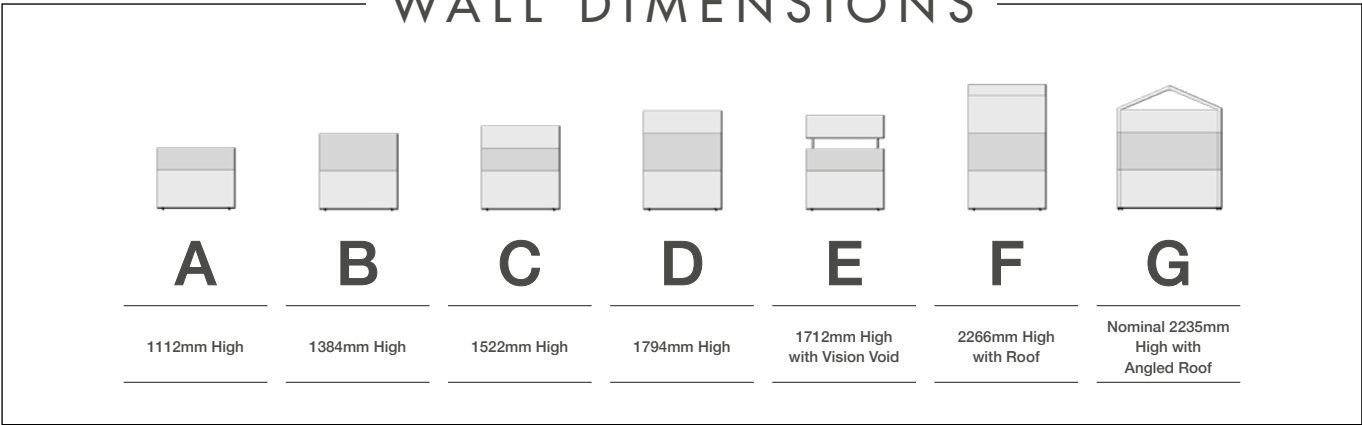

OVERALL DIMENSIONS

GOBI			SONORAN			ATACAMA		
	OA Width	OA Depth		OA Width	OA Depth		OA Width	OA Depth
MP20R-12	1294	1108	MP1-10	1000	1200	MP7L-12	1255	1545
MP20L-12	1294	1108	MP1-14	1400	1200	MP7R-12	1255	1545
MP21R-18	1800	1559	MP3-10	1945	1200	MP7L-23	2455	2290
MP21L-18	1800	1559	MP3-14	2745	1200	MP7R-23	2455	2290
MP23-17	855	1710	MP5-10	2890	1200	MP7L-32	3655	3035
			MP5-14	4090	1200	MP7R-32	3655	3035
			MP6-10	2890	2400			
			MP6-14	4090	2400			
			MP2-10	1000	2400			
			MP2-14	1400	2400			
			MP4-10	1945	2400			
			MP4-14	2745	2400			
			MP14-29	2900	1400			
SAHARA			COLORADO			KARAKUM		
	OA Width	OA Depth		OA Width	OA Depth		OA Width	OA Depth
MP11-25	2500	2600	MP28-30	3110	1555	MP17-13	2400	1370
MP10-30	3000	3000	MP25-30	3110	2873	MP17-18	2400	1870
MP12-50	5000	2600	MP26-30	3110	2992			

ELECTRICAL ACCESSORIES



DTPT-20
1x UK Power & Twin
USB Fast Charge 2x Cat 6 Data
(Desk top fixing only)



DTPT02U
2x UK Power & Twin
USB Fast Charge
(Desk top fixing only)



CLWP3
Starter Cable 3000mm
GST18/3 Female to 13A UK Plug



MPDTPXT/DTPXT
1x UK Power & Twin
USB Fast Charge
(POA)



DTPCA
Qi Compatible Aircharge Module
with Black Inner & Aluminium Bezel
(Desk top fixing only)



DTPCB
Qi Compatible Aircharge Module
with Black Inner & Black Bezel
(Desk top fixing only)



MPORT
80mm Dia. Circular
Double Sided Cable Port (Black)
(Wall panel fixing only £65 per port)



MPORT
80mm Dia. Circular
Double Sided Cable Port (Silver)
(Wall panel fixing only £65 per port)



MPORT
80mm Dia. Circular
Double Sided Cable Port (White)
(Wall panel fixing only £65 per port)

STATIONERY ACCESSORIES



VSTRA1
A4 Landscape Paper Tray
Available in Black or Silver



VSTRA2
A4 Portrait Paper Tray
Available in Black or Silver



VSTRA4
Stationery Tray
Available in Black or Silver

Fabric Selection 1

Please ensure when contacting our Sales Department full descriptions are used. Sales codes are made up of three elements: Product Code, Wall Height and Cable Management Type. For Cable Ports use 'P' and for Scallop Tops use 'S'.
Example: Sonoran with Level Height B with Cable Port would read MP5-14-B-P.

Key:

- Supplied with Cable Ports in Top Panel
- Supplied with PIR LED Lighting
- Option of Scallop/Cable Ports in Top Panel

Height Options

- A 1112mm High
- B 1384mm High
- C 1522mm High
- D 1794mm High
- E 1712mm High with Vision Void
- F 2266mm High with Roof
- G Nominal 2235mm High with Angled Roof

GOBI

Code	Description	A	B	C	D	E	F	G
MP20R-12	Single User Right Hand ■	£3,385	£4,166	-	£5,513	-	-	-
MP20L-12	Single User Left Hand ■	£3,385	£4,166	-	£5,513	-	-	-
MP21R-18	Single User Right Hand ■	£3,703	£4,234	-	£5,336	-	-	-
MP21L-18	Single User Left Hand ■	£3,703	£4,234	-	£5,336	-	-	-
MP23-17	Single User Semi Circular ■	£1,941	£2,244	-	£3,260	-	-	-

SONORAN

Code	Description	A	B	C	D	E	F	G
MP1-10	Small Single User ■	£2,793	£3,107	-	£4,372	£4,039	-	-
MP1-14	Large Single User ■	£2,906	£3,617	-	£4,680	£4,174	-	-
MP3-10	Small 2 User ■	£4,739	£5,198	-	£7,160	£7,025	-	-
MP3-14	Large 2 User ■	£4,824	£5,413	-	£7,390	£7,145	-	-
MP5-10	Small 3 User ■	£6,585	£6,828	-	£10,502	£10,664	-	-
MP5-14	Large 3 User ■	£7,447	£8,465	-	£11,803	£11,682	-	-
MP6-10	Small 6 Facing User ■	£13,458	£13,619	-	£18,812	£19,289	-	-
MP6-14	Large 6 Facing User ■	£13,574	£15,508	-	£20,193	£19,448	-	-
MP2-10	Small 2 Facing User ■	£4,815	£5,190	-	£7,178	£7,130	-	-
MP2-14	Large 2 Facing User ■	£4,920	£5,618	-	£7,622	£7,261	-	-
MP4-10	Small 4 Facing User ■	£9,257	£9,701	-	£13,387	£14,122	-	-
MP4-14	Large 4 Facing User ■	£9,849	£10,329	-	£13,941	£14,759	-	-
MP14-29	2 User Divider Wall ■	-	£7,853	£10,019	£10,862	-	-	-

ATACAMA

Code	Description	A	B	C	D	E	F	G
MP7L-12	2 User Left Hand ■	£2,597	£2,808	-	£3,945	-	-	-
MP7R-12	2 User Right Hand ■	£2,597	£2,808	-	£3,945	-	-	-
MP7L-23	4 User Left Hand ■	£4,403	£5,122	-	£6,645	-	-	-
MP7R-23	4 User Right Hand ■	£4,403	£5,122	-	£6,645	-	-	-
MP7L-32	6 User Left Hand ■	£6,494	£7,418	-	£9,703	-	-	-
MP7R-32	6 User Right Hand ■	£6,494	£7,418	-	£9,703	-	-	-

SAHARA

Code	Description	A	B	C	D	E	F	G
MP11-25	Single Entry Square	-	-	£9,672	£11,784	-	£21,764	-
MP10-30	Single Entry Soft Square	-	-	£10,163	£13,238	-	£22,607	-
MP12-50	Twin Entry Rectangular	-	-	£15,715	£19,978	-	£36,646	-

COLORADO

Code	Description	A	B	C	D	E	F	G
MP28-30	Semi Circular	-	£4,034	£4,606	£5,464	-	-	-
MP25-30	Twin Entry Circular	-	-	£7,019	£7,778	-	£13,185	-
MP26-30	Single Entry Circular	-	-	£7,828	£8,696	-	£14,681	-

KARAKUM

Code	Description	A	B	C	D	E	F	G
MP17-13	4 User Angled Roof ■	-	-	-	-	-	-	£14,840
MP17-18	6 User Angled Roof ■	-	-	-	-	-	-	£16,643

Fabric Selection 2

Please ensure when contacting our Sales Department full descriptions are used. Sales codes are made up of three elements: Product Code, Wall Height and Cable Management Type. For Cable Ports use 'P' and for Scallop Tops use 'S'.
Example: Sonoran with Level Height B with Cable Port would read MP5-14-B-P.

Key:

- Supplied with Cable Ports in Top Panel
- Supplied with PIR LED Lighting
- Option of Scallop/Cable Ports in Top Panel

Height Options

- A 1112mm High
- B 1384mm High
- C 1522mm High
- D 1794mm High
- E 1712mm High with Vision Void
- F 2266mm High with Roof
- G Nominal 2235mm High with Angled Roof

GOBI



Code	Description		A	B	C	D	E	F	G
MP20R-12	Single User Right Hand	■	£3,492	£4,222	-	£5,534	-	-	-
MP20L-12	Single User Left Hand	■	£3,492	£4,222	-	£5,534	-	-	-
MP21R-18	Single User Right Hand	■	£3,761	£4,354	-	£5,631	-	-	-
MP21L-18	Single User Left Hand	■	£3,761	£4,354	-	£5,631	-	-	-
MP23-17	Single User Semi Circular	■	£2,062	£2,359	-	£3,357	-	-	-

SONORAN

Code	Description		A	B	C	D	E	F	G
MP1-10	Small Single User	■	£2,811	£3,158	-	£4,414	£4,330	-	-
MP1-14	Large Single User	■	£2,976	£3,693	-	£4,967	£4,901	-	-
MP3-10	Small 2 User	■	£5,517	£5,905	-	£8,312	£8,377	-	-
MP3-14	Large 2 User	■	£5,776	£6,429	-	£8,854	£8,687	-	-
MP5-10	Small 3 User	■	£7,427	£7,881	-	£11,164	£11,349	-	-
MP5-14	Large 3 User	■	£8,149	£9,034	-	£12,410	£12,200	-	-
MP6-10	Small 6 Facing User	■	£14,013	£14,299	-	£19,728	£20,455	-	-
MP6-14	Large 6 Facing User	■	£14,448	£16,375	-	£21,911	£21,028	-	-
MP2-10	Small 2 Facing User	■	£5,589	£6,177	-	£8,539	£8,410	-	-
MP2-14	Large 2 Facing User	■	£5,802	£6,748	-	£9,213	£8,741	-	-
MP4-10	Small 4 Facing User	■	£10,060	£10,500	-	£14,451	£14,746	-	-
MP4-14	Large 4 Facing User	■	£10,497	£11,478	-	£15,533	£15,313	-	-
MP14-29	2 User Divider Wall	■	-	£8,093	£10,232	£10,887	-	-	-

ATACAMA

Code	Description		A	B	C	D	E	F	G
MP7L-12	2 User Left Hand	■	£2,632	£2,905	-	£4,004	-	-	-
MP7R-12	2 User Right Hand	■	£2,632	£2,905	-	£4,004	-	-	-
MP7L-23	4 User Left Hand	■	£4,923	£5,512	-	£7,343	-	-	-
MP7R-23	4 User Right Hand	■	£4,923	£5,512	-	£7,343	-	-	-
MP7L-32	6 User Left Hand	■	£7,286	£8,150	-	£10,824	-	-	-
MP7R-32	6 User Right Hand	■	£7,286	£8,150	-	£10,824	-	-	-

SAHARA

Code	Description		A	B	C	D	E	F	G
MP11-25	Single Entry Square		-	-	£10,087	£12,086	-	£22,471	-
MP10-30	Single Entry Soft Square		-	-	£10,337	£13,364	-	£23,168	-
MP12-50	Twin Entry Rectangular		-	-	£16,188	£20,255	-	£37,807	-

COLORADO

Code	Description		A	B	C	D	E	F	G
MP28-30	Semi Circular		-	£4,088	£4,795	£5,642	-	-	-
MP25-30	Twin Entry Circular		-	-	£7,180	£8,454	-	£14,920	-
MP26-30	Single Entry Circular		-	-	£8,379	£9,869	-	£17,088	-

KARAKUM

Code	Description		A	B	C	D	E	F	G
MP17-13	4 User Angled Roof	■	-	-	-	-	-	-	£15,328
MP17-18	6 User Angled Roof	■	-	-	-	-	-	-	£16,795

Fabric Selection 3

Please ensure when contacting our Sales Department full descriptions are used. Sales codes are made up of three elements: Product Code, Wall Height and Cable Management Type. For Cable Ports use 'P' and for Scallop Tops use 'S'.
Example: Sonoran with Level Height B with Cable Port would read MP5-14-B-P.

Key:

- Supplied with Cable Ports in Top Panel
- Supplied with PIR LED Lighting
- Option of Scallop/Cable Ports in Top Panel

Height Options

- A 1112mm High
- B 1384mm High
- C 1522mm High
- D 1794mm High
- E 1712mm High with Vision Void
- F 2266mm High with Roof
- G Nominal 2235mm High with Angled Roof

GOBI

Code	Description	A	B	C	D	E	F	G
MP20R-12	Single User Right Hand ■	£3,687	£4,582	-	£6,009	-	-	-
MP20L-12	Single User Left Hand ■	£3,687	£4,582	-	£6,009	-	-	-
MP21R-18	Single User Right Hand ■	£5,069	£5,300	-	£7,179	-	-	-
MP21L-18	Single User Left Hand ■	£5,069	£5,300	-	£7,179	-	-	-
MP23-17	Single User Semi Circular ■	£2,872	£3,383	-	£4,581	-	-	-

SONORAN

Code	Description	A	B	C	D	E	F	G
MP1-10	Small Single User ■	£3,591	£3,976	-	£4,870	£4,776	-	-
MP1-14	Large Single User ■	£3,757	£4,434	-	£5,721	£5,407	-	-
MP3-10	Small 2 User ■	£6,078	£6,506	-	£9,173	£9,246	-	-
MP3-14	Large 2 User ■	£6,357	£7,078	-	£9,766	£9,582	-	-
MP5-10	Small 3 User ■	£8,177	£8,677	-	£12,316	£12,523	-	-
MP5-14	Large 3 User ■	£8,964	£9,942	-	£13,684	£13,453	-	-
MP6-10	Small 6 Facing User ■	£15,437	£15,762	-	£21,780	£22,578	-	-
MP6-14	Large 6 Facing User ■	£15,906	£17,149	-	£23,088	£22,842	-	-
MP2-10	Small 2 Facing User ■	£6,157	£6,807	-	£9,427	£9,287	-	-
MP2-14	Large 2 Facing User ■	£6,387	£7,433	-	£10,166	£9,644	-	-
MP4-10	Small 4 Facing User ■	£11,088	£11,583	-	£15,963	£16,283	-	-
MP4-14	Large 4 Facing User ■	£11,556	£12,483	-	£17,148	£16,897	-	-
MP14-29	2 User Divider Wall ■	-	£8,473	£10,718	£11,943	-	-	-

ATACAMA

Code	Description	A	B	C	D	E	F	G
MP7L-12	2 User Left Hand ■	£2,874	£3,178	-	£4,392	-	-	-
MP7R-12	2 User Right Hand ■	£2,874	£3,178	-	£4,392	-	-	-
MP7L-23	4 User Left Hand ■	£5,368	£6,021	-	£8,049	-	-	-
MP7R-23	4 User Right Hand ■	£5,368	£6,021	-	£8,049	-	-	-
MP7L-32	6 User Left Hand ■	£7,943	£8,902	-	£11,864	-	-	-
MP7R-32	6 User Right Hand ■	£7,943	£8,902	-	£11,864	-	-	-

SAHARA

Code	Description	A	B	C	D	E	F	G
MP11-25	Single Entry Square	-	-	£10,675	£12,686	-	£24,224	-
MP10-30	Single Entry Soft Square	-	-	£11,254	£14,030	-	£24,328	-
MP12-50	Twin Entry Rectangular	-	-	£17,643	£21,267	-	£39,700	-

COLORADO

Code	Description	A	B	C	D	E	F	G
MP28-30	Semi Circular	-	£4,491	£5,261	£6,193	-	-	-
MP25-30	Twin Entry Circular	-	-	£7,884	£9,283	-	£16,391	-
MP26-30	Single Entry Circular	-	-	£9,200	£10,835	-	£18,769	-

KARAKUM

Code	Description	A	B	C	D	E	F	G
MP17-13	4 User Angled Roof ■	-	-	-	-	-	-	£16,085
MP17-18	6 User Angled Roof ■	-	-	-	-	-	-	£18,043

Fabric Selection 4

Please ensure when contacting our Sales Department full descriptions are used. Sales codes are made up of three elements: Product Code, Wall Height and Cable Management Type. For Cable Ports use 'P' and for Scallop Tops use 'S'.
Example: Sonoran with Level Height B with Cable Port would read MP5-14-B-P.

Key:

- Supplied with Cable Ports in Top Panel
- Supplied with PIR LED Lighting
- Option of Scallop/Cable Ports in Top Panel

Height Options

- A 1112mm High
- B 1384mm High
- C 1522mm High
- D 1794mm High
- E 1712mm High with Vision Void
- F 2266mm High with Roof
- G Nominal 2235mm High with Angled Roof

GOBI



Code	Description		A	B	C	D	E	F	G
MP20R-12	Single User Right Hand	■	£3,755	£4,636	-	£6,131	-	-	-
MP20L-12	Single User Left Hand	■	£3,755	£4,636	-	£6,131	-	-	-
MP21R-18	Single User Right Hand	■	£5,404	£6,052	-	£7,868	-	-	-
MP21L-18	Single User Left Hand	■	£5,404	£6,052	-	£7,868	-	-	-
MP23-17	Single User Semi Circular	■	£3,244	£3,785	-	£4,964	-	-	-

SONORAN

Code	Description		A	B	C	D	E	F	G
MP1-10	Small Single User	■	£3,862	£4,636	-	£6,100	£5,600	-	-
MP1-14	Large Single User	■	£4,014	£5,044	-	£6,529	£5,784	-	-
MP3-10	Small 2 User	■	£6,503	£7,145	-	£9,894	£9,705	-	-
MP3-14	Large 2 User	■	£6,590	£7,411	-	£10,179	£9,842	-	-
MP5-10	Small 3 User	■	£8,945	£9,206	-	£12,963	£13,344	-	-
MP5-14	Large 3 User	■	£9,066	£10,485	-	£14,242	£13,516	-	-
MP6-10	Small 6 Facing User	■	£15,412	£15,834	-	£21,856	£22,436	-	-
MP6-14	Large 6 Facing User	■	£15,959	£17,489	-	£23,541	£23,054	-	-
MP2-10	Small 2 Facing User	■	£6,622	£7,145	-	£9,934	£9,870	-	-
MP2-14	Large 2 Facing User	■	£6,729	£7,709	-	£10,515	£10,010	-	-
MP4-10	Small 4 Facing User	■	£11,345	£11,843	-	£16,382	£16,620	-	-
MP4-14	Large 4 Facing User	■	£11,696	£12,611	-	£17,170	£17,018	-	-
MP14-29	2 User Divider Wall	■	-	£8,514	£11,387	£11,865	-	-	-

ATACAMA

Code	Description		A	B	C	D	E	F	G
MP7L-12	2 User Left Hand	■	£3,601	£4,247	-	£5,523	-	-	-
MP7R-12	2 User Right Hand	■	£3,601	£4,247	-	£5,523	-	-	-
MP7L-23	4 User Left Hand	■	£5,865	£6,892	-	£9,024	-	-	-
MP7R-23	4 User Right Hand	■	£5,865	£6,892	-	£9,024	-	-	-
MP7L-32	6 User Left Hand	■	£8,548	£9,764	-	£12,971	-	-	-
MP7R-32	6 User Right Hand	■	£8,548	£9,764	-	£12,971	-	-	-

SAHARA

Code	Description		A	B	C	D	E	F	G
MP11-25	Single Entry Square		-	-	£10,982	£13,089	-	£21,572	-
MP10-30	Single Entry Soft Square		-	-	£11,554	£14,716	-	£25,164	-
MP12-50	Twin Entry Rectangular		-	-	£17,858	£22,197	-	£40,720	-

COLORADO

Code	Description		A	B	C	D	E	F	G
MP28-30	Semi Circular		-	£5,842	£6,372	£7,118	-	-	-
MP25-30	Twin Entry Circular		-	-	£9,038	£9,935	-	£16,856	-
MP26-30	Single Entry Circular		-	-	£10,059	£11,085	-	£18,753	-

KARAKUM

Code	Description		A	B	C	D	E	F	G
MP17-13	4 User Angled Roof	■	-	-	-	-	-	-	£16,355
MP17-18	6 User Angled Roof	■	-	-	-	-	-	-	£18,356

MIRAGE HAZE SCREENS & PODS

5 Year
Guarantee

Mirage Haze is a customisable alternative for break-out spaces. The metal framework can be specified to create boundless potentials of shapes and sizes to suit the ergonomic needs of the office environment. Walls can be specified in a trio of finishes, including upholstery, glass and laminate (available on request). Enhanced by the addition of sound-absorbing ceiling tiles, infrared lighting technology, and fans that provide air circulation, this pod's space utilisation is decisively maximised.

Additional Information:

- Prices do not include installation which is mandatory by Gresham qualified installers. Installation costs will be an additional charge and will be supplied on completion of a Gresham consultation or site survey form.
- Prices include posts, cross rails, ceiling, lighting, sliding door, all fixings and all panels.
- All pods are 2200mm high.
- For any pods with dividing walls, the dividing wall will be upholstered in fabric.
- Available with Silver, White or Black trim.

Screens & Pods

Description	Code	Width	Depth	Footprint (m ²)	Suitable For	Recommended Table	Band 1	Band 2	Ceiling Cover
Square									
Half Glazed	MHS2020HG	2000 x	2000	4	1 person	Ø800	£15,847	£16,997	£1,812
Half Glazed	MHS2525HG	2500 x	2500	6.25	3 people	Ø800	£22,185	£23,745	£2,826
Half Glazed	MHS3030HG	3000 x	3000	9	4 people	Ø1000	£24,176	£25,828	£4,075
1 Wall Glazed	MHS2020WG	2000 x	2000	4	1 person	Ø800	£16,845	£18,567	£1,812
1 Wall Glazed	MHS2525WG	2500 x	2500	6.25	3 people	Ø800	£22,576	£26,271	£2,826
1 Wall Glazed	MHS3030WG	3000 x	3000	9	4 people	Ø1000	£25,610	£28,088	£4,075
Rectangular									
Half Glazed	MHR1520HG	1500 x	2000	3	1 person	1200 x 800 or Ø800	£14,692	£15,346	£1,359
Half Glazed	MHR2030HG	2000 x	3000	6	2 people	Ø800	£23,172	£24,610	£2,712
Half Glazed	MHR2530HG	2500 x	3000	7.5	3 people	Ø800	£26,623	£28,344	£3,654
Half Glazed	MHR2540HG	2500 x	4000	10	3 people	Ø1000	£29,946	£31,954	£4,527
Half Glazed	MHR3040HG	3000 x	4000	12	6 people	1800 x 1000	£30,860	£32,513	£5,432
Half Glazed	MHR3050HG	3000 x	5000	15	6 people	2000 x 1000	£35,404	£37,698	£6,790
1 Wall Glazed	MHR1520WG	1500 x	2000	3	1 person	1200 x 800 or Ø800	£14,919	£16,192	£1,359
1 Wall Glazed	MHR2030WG	2000 x	3000	6	2 people	Ø800	£23,399	£25,456	£2,712
1 Wall Glazed	MHR2530WG	2500 x	3000	7.5	3 people	Ø800	£26,966	£29,615	£3,654
1 Wall Glazed	MHR2540WG	2500 x	4000	10	3 people	Ø1000	£30,288	£33,225	£4,527
1 Wall Glazed	MHR3040WG	3000 x	4000	12	6 people	1800 x 1000	£31,201	£33,782	£5,432
1 Wall Glazed	MHR3050WG	3000 x	5000	15	6 people	2000 x 1000	£35,747	£38,966	£6,790
Rectangular Divide									
Half Glazed	MHR5025DHG	5000 x	2500	12.5	6 people	Ø800 x2	£36,906	£39,846	£5,660
Half Glazed	MHR4030DHG	4000 x	3000	12	4 people	Ø800 x2	£35,151	£37,604	£5,432
Half Glazed	MHR5030DHG	5000 x	3000	15	6 people	Ø800 x2	£40,914	£44,121	£6,790
Half Glazed	MHR6030DHG	6000 x	3000	18	8 people	Ø1000 x2	£43,911	£47,093	£8,148
1 Wall Glazed	MHR5025DWG	5000 x	2500	12.5	6 people	Ø800 x2	£37,589	£42,386	£5,660
1 Wall Glazed	MHR4030DWG	4000 x	3000	12	4 people	Ø800 x2	£35,834	£40,143	£5,432
1 Wall Glazed	MHR5030DWG	5000 x	3000	15	6 people	Ø800 x2	£41,598	£46,662	£6,790
1 Wall Glazed	MHR6030DWG	6000 x	3000	18	8 people	Ø1000 x2	£44,592	£49,631	£8,148
Circular									
Half Glazed	MHC30HG	Ø3170		7	4 people	Ø1000	£21,496	£23,338	£3,169
1 Wall Glazed	MHC30WG	Ø3170		7	4 people	Ø1000	£24,385	£25,007	£3,169
Half Loop									
Half Glazed	MHH2530HG	2500 x	3170	7.5	3 people	Ø800	£28,430	£29,682	£3,654
Half Glazed	MHH3030HG	3000 x	3170	9	4 people	Ø1000	£28,670	£30,265	£4,075
Half Glazed	MHH4030HG	4000 x	3170	12	5 people	1800 x 1000	£32,507	£34,822	£5,432
Half Glazed	MHH5030HG	5000 x	3170	14	6 people	2000 x 1000	£36,774	£38,783	£6,337

Mirage Haze is flexible, for alternative footprints and heights please contact our Sales Department.

Office pod system integrated with sound-insulating properties. Tested to BS EN ISO 140-4:1998 and has a noise absorption rate of 28-30dB. Please note a Ceiling Cover may only be required when the top of the pod is visible from above (near stairs, atriums etc) to hide electrics. Air Circulation unit cannot be covered. The Ceiling Cover is fabric wrapped to match the internal fabric of the pod ceiling.

ACCESSORIES

Accessories must be specified at point of order.



Slow Door Closure
MH/SDC
£714



Monitor Mount - Large
MH/MM2
£706



Door Lock
MH/DL
£714



Air Circulation
MH/AC
£1,554



Sound Absorbing Underlay
MH/UNDERLAY
POA

RECTANGULAR PODS ONLY

RECTANGULAR PODS ONLY



OPTIONAL FEATURES

Optional features must be specified at point of order.

Manifestations - Spots

Opal frosted vinyl spots are supplied on all doors as standard and are available on other glazed panels as an option.

Code	Description	Price
MHSPOT50	Opal frosted vinyl spots (50) Vinyl artwork or logos	£269 POA

(Diagram shows opal frosted vinyl spots double row of 50. This complies with The Building Regulations 2010, part K5)

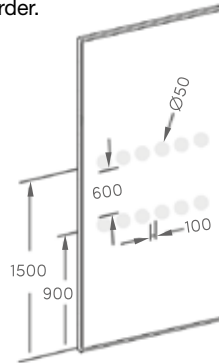

FABRIC OPTIONS

Band 1
Camira Carlow
Camira Manhattan
Camira Sonus
Camira Cara

Band 2
Camira Blazer
Camira Blazer Lite
Camira Main Line Flax
Camira Main Line Plus
Camira Synergy
Agua Buro
Inloom Jet Bioactive
Inloom One
Inloom Roccia

Outlet Type/Quantities

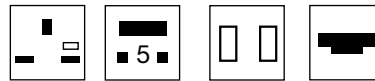

Electrics

- Posts can be positioned in any wall except where sliding doors hang or in the corners of a pod.
- All leads are 3m long from termination point at top/bottom of post. Longer leads are available (POA).
- Supplied as 2 gang or 1 gang sockets in Black or Silver with Black fascias, containing the following options:
- Outlets are positioned 800mm from floor as standard.

Code	UK POWER	CAT 5e DATA	TWIN USB FAST CHARGE	HDMI	Price
MH/2P/1D	2	1	-	-	£1,218
MH/2P/1H	2	-	-	1	£1,381
MH/1H	-	-	-	1	£1,135
MH/1H/1D	-	1	-	1	£1,282
MH/1D	-	1	-	-	£719
MH/1T	-	-	1	-	£1,005
MH/1P/1T	1	-	1	-	£1,059
MH/2P	2	-	-	-	£729



Mirage Haze Square Half Glazed

MIRAGE HAZE PHONE BOOTH

SCREENS & PODS



The Mirage Haze phone booth has improved acoustics (rated at 36dB noise reduction) and an updated modern aesthetic. To achieve the improved acoustics, 22mm double glazed panels, 6mm glazed doors, 55mm sound absorbing upholstered panels and 50mm sound absorbing ceiling tiles have been utilised. The design includes an integrated facilities loop housing the PIR operated LED strip lighting and air circulation system.

Additional Information:

- Prices do not include installation which is mandatory by Gresham qualified installers. Installation costs will be an additional charge and will be supplied on completion of a Gresham consultation or site survey form.
- Acoustically tested to BSEN ISO 140 and rated at 36dB noise reduction.
- 55mm sound absorbing upholstered panels.
- 22mm double glazed glass panels.
- 6mm hinged glass door with manifestations.
- 50mm sound absorbing ceiling panels upholstered in light grey.
- Integrated ceiling cover included as standard.
- Integrated facilities arch included as standard housing lighting system.
- PIR operated, high output – low voltage, diffused, dual LED strip lighting included as standard.
- Air circulation fan with 216m³/h airflow included as standard.
- Optional flush mounted modules available with power or TUF.
- 2100mm high (2380mm high with air circulation).
- Available with optional shelf. £360 (White or Black)
- Available with Silver, White or Black trim.

Screens & Pods

Description	Code	Width	Depth	Footprint (m ²)	Suitable For	Recommended Table	Band 1	Band 2	Ceiling Cover
1 Wall Glazed	MZ1WG	1000	x 1000	1	1 person	N/A	£14,331	£15,303	INC.



5 Year
Guarantee

NEW
PRODUCT

MIRAGE HAZE PHONE BOOTH SCREENS & PODS



Screens & Pods

GE MOBILE PODS

SCREENS & PODS



GE Mobile Pods are one of a kind in flexibility and sociability. Create a customisable meeting space with pods on castors. Personalise an away-from-desk space with a selection of fabrics and MFC finishes that create a fun and informal way to socialise.

Additional Information:
Fabric Selections as per Mirage Pods.



Screens & Pods

Code	Thumbnail	Description	Price	Fabric Selection 3	Fabric Selection 4
GE21A1		2 User Mobile Meeting Pod Angled Roof & Integrated Seating 2400w x 700d x 2235h (Seat height 460mm) Optional LED PIR Lighting (suffix L) GE21KIT1 Linking Kit	£1,956 £153	£8,792	£9,129
GE21B1		2 User Mobile Meeting Pod Angled Roof, Back Panel & Integrated Seating 2400w x 755d x 2235h (Seat height 460mm) Optional LED PIR Lighting (suffix L) Optional TV/ Monitor mount bracket (suffix T) GE21KIT1 Linking Kit	£1,956 £461 £153		£12,847
GE22A1		2 User Mobile Meeting Pod Angled Roof & Integrated Full Width Table 2400w x 700d x 2235h <i>(must be linked to one of the above)</i> Optional LED PIR Lighting (suffix L) GE21KIT1 Linking Kit	£1,956 £153		£7,247
GE23A1		Rectangular Upholstered Centre Cube Fitted with Glides 1000w x 700d x 460h (Seat height 460mm)			£920

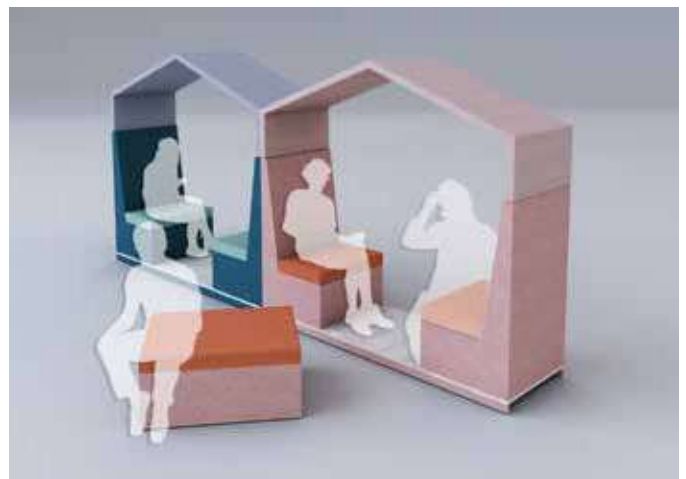
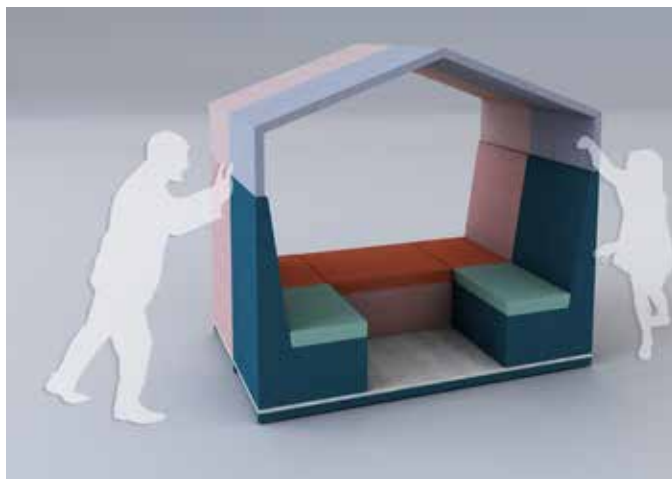

EXAMPLE CONFIGURATIONS

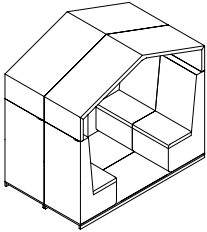

2x GE21A1
1x GE21KIT1

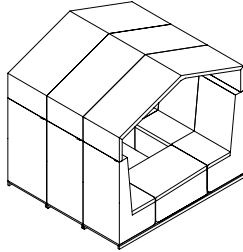

3x GE21A1
1x GE23A1
2x GE21KIT1

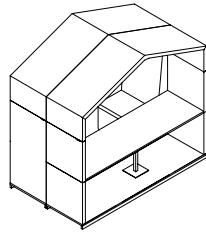

1x GE21A1
1x GE22A1
1x GE21KIT1

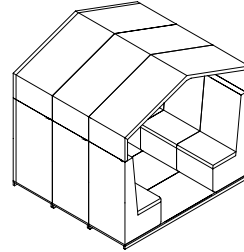

2x GE21A1
1x GE21B1
2x GE21KIT1

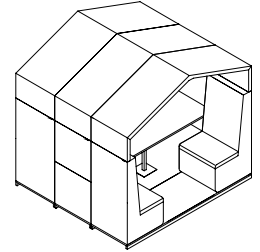

2x GE21A1
1x GE22A1
2x GE21KIT1

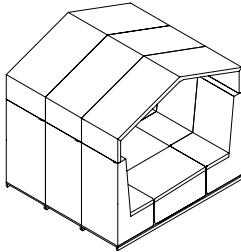

3x GE21A1
3x GE23A1
2x GE21KIT1

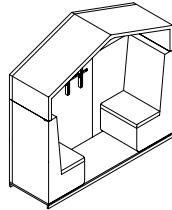

1x GE21B1T

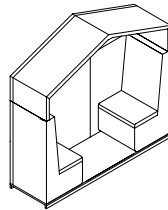

1x GE21B1

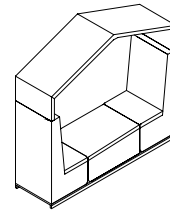

1x GE21A1
1x GE23A1

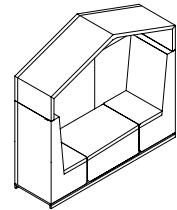

1x GE21B1
1x GE23A1



GE21A1 with GE23A1 Centre Cube

GE6 MOBILE SCREENS & PODS



Floor standing mobile privacy panels available as rectangular or curved in various heights. GE6 Mobile can be used to partition offices to create collaborative areas.

These screens can be upholstered in a choice of vibrant fabrics that not only help to delineate user space but also can add colour highlights to modern workplace environments.

Additional Information:

- Fabric wrapped, prices shown are for single fabrics only.
- Available with 4 or 6 panels.
- Supplied with base in black, white, silver or grey as standard.
- Supplied with castors.

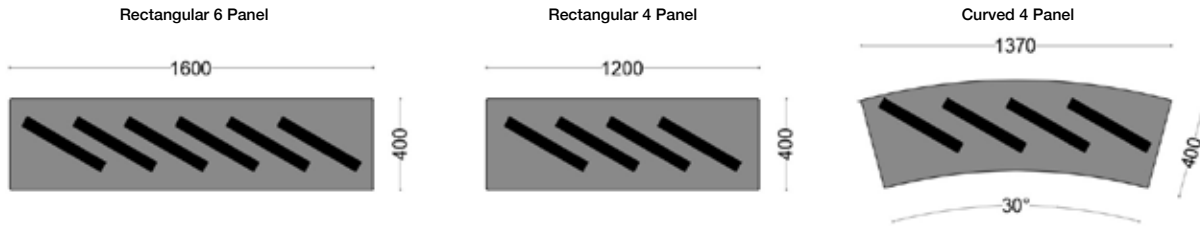

Screens & Pods

Code	Overall Height	Panel Width	Cara Carlow	Blazer/ Synergy/ Aspect/Patina/X2/ Agua Buro Inloom Jet Bioactive/ Roccia		
				Blazer Lite Sonus		
Rectangular 4 Panel						
GE6A1	1200	x	400	£2,627	£2,854	£2,870
GE6A2	1600	x	400	£2,874	£2,905	£3,362
GE6A3	1800	x	400	£2,982	£3,564	£3,578
Rectangular 6 Panel						
GE6B1	1200	x	400	£3,365	£3,700	£3,724
GE6B2	1600	x	400	£3,733	£3,780	£4,464
GE6B3	1800	x	400	£3,897	£4,766	£4,790
Curved 4 Panel						
GE6E1	1200	x	400	£4,684	£4,959	£5,081
GE6E2	1600	x	400	£4,936	£4,995	£5,724
GE6E3	1800	x	400	£4,955	£5,501	£5,741



Rectangular 4 Panel GE6 Mobile with White Base

Floor standing static privacy panels available as rectangular in two widths and two heights. GE6 Static is supplied with heavyweight base and can be used to partition offices to create collaborative areas.

These screens can be upholstered in a choice of vibrant fabrics that not only help to delineate user space but also can add colour highlights to modern workplace environments.

Additional Information:

- Fabric wrapped, prices shown are for single fabrics only.
- Available with 3 or 4 panels.
- Supplied with base in black, white, silver or grey as standard.



Rectangular 3 Panel

Rectangular 4 Panel

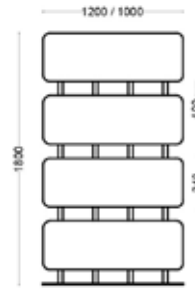
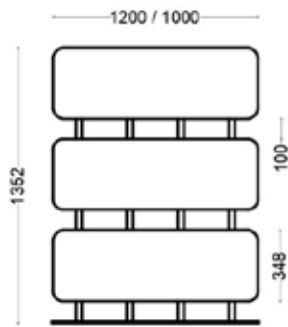

Blazer/ Synergy/
Aspect/Patina/X2/
Agua Buro
Inloom Jet
Bioactive/
Roccia

Code	Overall Height		Panel Width	Cara Carlow	Blazer Lite Sonus	Blazer/ Synergy/ Aspect/Patina/X2/ Agua Buro Inloom Jet Bioactive/ Roccia
Rectangular 3 Panel						
GE6C1	1352	x	1000	£2,712	£2,892	£2,994
GE6D1	1352	x	1200	£2,730	£2,916	£3,017
Rectangular 4 Panel						
GE6C2	1800	x	1000	£3,149	£3,391	£3,525
GE6D2	1800	x	1200	£3,177	£3,418	£3,555



Rectangular 4 Panel Static GE6

GOF DESK MOUNTED SCREENS & PODS

5 Year
Guarantee

Desk mounted screens can be used to reduce sound throughout a room whilst delineating personal space on desk clusters.



- Available in straight and wave-topped options.
- Aluminium frame includes integral tool-bar to top edge.
- Taller screens include additional tool-bar to centre.
- Fabric covered panels are offered in a selection of fabrics.

Screens & Pods

Code	Where used	W	D	H	Band 1	Band 2	Band 3
280mm High Straight - Fabric							
VSDF213	2030	1998	x 30	x 280	£365	£392	£433
VSDF203	2000	1968	x 30	x 280	£363	£389	£429
VSDF183	1800	1768	x 30	x 280	£322	£341	£384
VSDF173	1630	1598	x 30	x 280	£251	£264	£306
VSDF163	1600	1568	x 30	x 280	£250	£261	£304
VSDF143	1400	1368	x 30	x 280	£213	£228	£269
VSDF123	1200	1168	x 30	x 280	£204	£220	£264
VSDF103	1000	968	x 30	x 280	£197	£212	£254
VSDF083	800	768	x 30	x 280	£184	£204	£247
VSDF063	600	568	x 30	x 280	£170	£180	£220



380mm High Straight - Fabric							
VSDF214	2030	1998	x 30	x 380	£387	£406	£445
VSDF204	2000	1968	x 30	x 380	£384	£402	£443
VSDF184	1800	1768	x 30	x 380	£346	£363	£406
VSDF174	1630	1598	x 30	x 380	£270	£286	£326
VSDF164	1600	1568	x 30	x 380	£269	£285	£324
VSDF144	1400	1368	x 30	x 380	£227	£246	£287
VSDF124	1200	1168	x 30	x 380	£219	£235	£277
VSDF104	1000	968	x 30	x 380	£212	£225	£264
VSDF084	800	768	x 30	x 380	£193	£200	£243
VSDF064	600	568	x 30	x 380	£187	£192	£231



480mm High Straight - Fabric							
VSDF215	2030	1998	x 30	x 480	£422	£443	£483
VSDF205	2000	1968	x 30	x 480	£419	£440	£478
VSDF185	1800	1768	x 30	x 480	£384	£401	£442
VSDF175	1630	1598	x 30	x 480	£341	£360	£401
VSDF165	1600	1568	x 30	x 480	£328	£345	£386
VSDF145	1400	1368	x 30	x 480	£275	£287	£327
VSDF125	1200	1168	x 30	x 480	£261	£279	£321
VSDF105	1000	968	x 30	x 480	£255	£269	£311
VSDF085	800	768	x 30	x 480	£213	£220	£261
VSDF065	600	568	x 30	x 480	£202	£212	£254

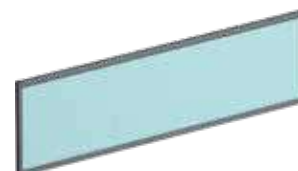

380/180mm High Wave - Fabric							
VSDF214W	2030	1998	x 30	x 380/180	£458	£475	£517
VSDF204W	2000	1968	x 30	x 380/180	£456	£473	£511
VSDF184W	1800	1768	x 30	x 380/180	£401	£422	£464
VSDF174W	1630	1598	x 30	x 380/180	£346	£360	£401
VSDF164W	1600	1568	x 30	x 380/180	£345	£358	£400
VSDF144W	1400	1368	x 30	x 380/180	£335	£351	£391
VSDF124W	1200	1168	x 30	x 380/180	£316	£331	£372
VSDF104W	1000	968	x 30	x 380/180	£308	£324	£364
VSDF084W	800	768	x 30	x 380/180	£270	£279	£321



480/280mm High Wave - Fabric							
VSDF215W	2030	1998	x 30	x 480/280	£488	£509	£551
VSDF205W	2000	1968	x 30	x 480/280	£483	£507	£549
VSDF185W	1800	1768	x 30	x 480/280	£433	£453	£494
VSDF175W	1630	1598	x 30	x 480/280	£387	£403	£444
VSDF165W	1600	1568	x 30	x 480/280	£386	£401	£442
VSDF145W	1400	1368	x 30	x 480/280	£356	£369	£410
VSDF125W	1200	1168	x 30	x 480/280	£340	£356	£396
VSDF105W	1000	968	x 30	x 480/280	£327	£346	£387
VSDF085W	800	768	x 30	x 480/280	£285	£297	£337



480mm High Fabric with Integral Toolbar							
Additional toolbar at 280mm high.							
VSDFT185	1800	1768	x 30	x 480	£424	£438	£465
VSDFT175	1630	1598	x 30	x 480	£387	£403	£444
VSDFT165	1600	1568	x 30	x 480	£361	£382	£422
VSDFT145	1400	1368	x 30	x 480	£309	£327	£367
VSDFT125	1200	1168	x 30	x 480	£280	£300	£340
VSDFT105	1000	968	x 30	x 480	£275	£288	£328
VSDFT085	800	768	x 30	x 480	£228	£245	£286

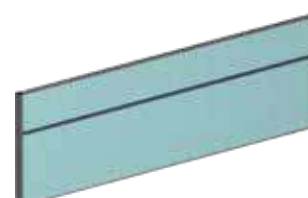

Code Where used W D H

480mm High Perforated Steel/Fabric with Integral Toolbar

Additional toolbar at 280mm high.

VSDST185	1800	1768	x	30	x	480
VSDST175	1630	1598	x	30	x	480
VSDST165	1600	1568	x	30	x	480
VSDST145	1400	1368	x	30	x	480
VSDST125	1200	1168	x	30	x	480
VSDST105	1000	968	x	30	x	480
VSDST085	800	768	x	30	x	480

Band 1	Band 2	Band 3	Colour Surcharge
£473	£492	£533	-
£395	£410	£453	-
£382	£391	£432	-
£356	£365	£408	-
£331	£346	£387	-
£305	£316	£358	-
£286	£300	£340	-

480mm High Acrylic/Fabric with Integral Toolbar

Additional toolbar at 280mm high.

VSDAT185	1800	1768	x	30	x	480
VSDAT175	1630	1598	x	30	x	480
VSDAT165	1600	1568	x	30	x	480
VSDAT145	1400	1368	x	30	x	480
VSDAT125	1200	1168	x	30	x	480
VSDAT105	1000	968	x	30	x	480
VSDAT085	800	768	x	30	x	480

£421	£442	£482	£32
£328	£345	£386	£32
£326	£341	£382	£32
£306	£318	£360	£32
£285	£300	£340	£32
£261	£278	£319	£32
£243	£251	£293	£32



Screens & Pods

Code Where used W Price

380mm High Magnetic Dry Wipe Board

Price is per side and additional to fabric screen. Specify screen base code with suffix:

-DB	2030	1998 wide screen	£105
-DB	2000	1968 wide screen	£104
-DB	1800	1768 wide screen	£95
-DB	1630	1598 wide screen	£87
-DB	1600	1568 wide screen	£85
-DB	1400	1368 wide screen	£75
-DB	1200	1168 wide screen	£64
-DB	1000	968 wide screen	£54
-DB	800	768 wide screen	£44
-DB	600	568 wide screen	£39



480mm High Magnetic Dry Wipe Board

Price is per side and additional to fabric screen. Specify screen base code with suffix:

-DB	2030	1998 wide screen	£134
-DB	2000	1968 wide screen	£132
-DB	1800	1768 wide screen	£120
-DB	1630	1598 wide screen	£109
-DB	1600	1568 wide screen	£106
-DB	1400	1368 wide screen	£96
-DB	1200	1168 wide screen	£81
-DB	1000	968 wide screen	£66
-DB	800	768 wide screen	£54
-DB	600	568 wide screen	£44



Wave Fabric Desk Mounted Screens

GOF DESK MOUNTED SCREENS & PODS

5 Year
Guarantee

Perforated steel screens can be colour co-ordinated to match adjacent desk steelwork. They offer privacy with partial light transfer.

- Available in straight and wave-topped options.
- Can accept magnetic accessories / stationery.
- Aluminium frame includes integral tool-bar to top edge.



Code	Where used	W	D	H	Price
------	------------	---	---	---	-------

280mm High Straight Perforated Steel

VSDS213	2030	1998	x 30	x 280	£361
VSDS203	2000	1968	x 30	x 280	£358
VSDS183	1800	1768	x 30	x 280	£302
VSDS173	1630	1598	x 30	x 280	£294
VSDS163	1600	1568	x 30	x 280	£287
VSDS143	1400	1368	x 30	x 280	£270
VSDS123	1200	1168	x 30	x 280	£251
VSDS103	1000	968	x 30	x 280	£231
VSDS083	800	768	x 30	x 280	£215
VSDS063	600	568	x 30	x 280	£196



380mm High Straight Perforated Steel

VSDS214	2030	1998	x 30	x 380	£421
VSDS204	2000	1968	x 30	x 380	£417
VSDS184	1800	1768	x 30	x 380	£351
VSDS174	1630	1598	x 30	x 380	£331
VSDS164	1600	1568	x 30	x 380	£324
VSDS144	1400	1368	x 30	x 380	£306
VSDS124	1200	1168	x 30	x 380	£273
VSDS104	1000	968	x 30	x 380	£258
VSDS084	800	768	x 30	x 380	£243
VSDS064	600	568	x 30	x 380	£221



480mm High Straight Perforated Steel

VSDS215	2030	1998	x 30	x 480	£469
VSDS205	2000	1968	x 30	x 480	£467
VSDS185	1800	1768	x 30	x 480	£389
VSDS175	1630	1598	x 30	x 480	£365
VSDS165	1600	1568	x 30	x 480	£363
VSDS145	1400	1368	x 30	x 480	£346
VSDS125	1200	1168	x 30	x 480	£316
VSDS105	1000	968	x 30	x 480	£288
VSDS085	800	768	x 30	x 480	£259
VSDS065	600	568	x 30	x 480	£242



380/180mm High Wave Perforated Steel

VSDS214W	2030	1998	x 30	x 380/180	£492
VSDS204W	2000	1968	x 30	x 380/180	£490
VSDS184W	1800	1768	x 30	x 380/180	£410
VSDS174W	1630	1598	x 30	x 380/180	£401
VSDS164W	1600	1568	x 30	x 380/180	£392
VSDS144W	1400	1368	x 30	x 380/180	£388
VSDS124W	1200	1168	x 30	x 380/180	£365
VSDS104W	1000	968	x 30	x 380/180	£355
VSDS084W	800	768	x 30	x 380/180	£309



480/280mm High Wave Perforated Steel

VSDS215W	2030	1998	x 300	x 480/280	£544
VSDS205W	2000	1968	x 300	x 480/280	£538
VSDS185W	1800	1768	x 30	x 480/280	£442
VSDS175W	1630	1598	x 30	x 480/280	£425
VSDS165W	1600	1568	x 30	x 480/280	£424
VSDS145W	1400	1368	x 30	x 480/280	£409
VSDS125W	1200	1168	x 30	x 480/280	£384
VSDS105W	1000	968	x 30	x 480/280	£361
VSDS085W	800	768	x 30	x 480/280	£326



5 Year
Guarantee

GOF DESK MOUNTED SCREENS & PODS



Screens & Pods

Wave Perforated Steel Desk Mounted Screens

GOF DESK MOUNTED SCREENS & PODS

5 Year
Guarantee

Acrylic screens can have their frame colours co-ordinated to match adjacent desk steelwork. They offer privacy with nearly full light transfer.

- Available in straight or wave-topped options.
- Aluminium frame includes integral tool-bar to top edge.
- Acrylic available in clear, frosted or a selection of colours - Specify at point of order.

Acrylic Options



S2 000 S2 030
Clear Polar Frost

Coloured Frosted Acrylic Options - Surcharge

(More colours available, see Technical Information section).



S2 9T21 S2 4T50 S2 2T07 S2 7T1F S2 3T17 S2 6T21 S2 6T9A
Stone Chilli Citrus Azure Mandarin Glacier Lime
Grey Red Yellow Blue Orange Green Zest



Code	Where used	W	D	H	Clear or Frosted	Colours Surcharge
280mm High Straight Acrylic						
VSDA213	2030	1998	x 30	x 280	£266	£32
VSDA203	2000	1968	x 30	x 280	£265	£32
VSDA183	1800	1768	x 30	x 280	£251	£32
VSDA173	1630	1598	x 30	x 280	£241	£32
VSDA163	1600	1568	x 30	x 280	£231	£32
VSDA143	1400	1368	x 30	x 280	£215	£32
VSDA123	1200	1168	x 30	x 280	£193	£32
VSDA103	1000	968	x 30	x 280	£178	£32
VSDA083	800	768	x 30	x 280	£156	£32
VSDA063	600	568	x 30	x 280	£139	£32



380mm High Straight Acrylic						
VSDA214	2030	1998	x 30	x 380	£309	£45
VSDA204	2000	1968	x 30	x 380	£308	£45
VSDA184	1800	1768	x 30	x 380	£294	£45
VSDA174	1630	1598	x 30	x 380	£275	£45
VSDA164	1600	1568	x 30	x 380	£270	£45
VSDA144	1400	1368	x 30	x 380	£250	£45
VSDA124	1200	1168	x 30	x 380	£225	£45
VSDA104	1000	968	x 30	x 380	£202	£45
VSDA084	800	768	x 30	x 380	£184	£45
VSDA064	600	568	x 30	x 380	£162	£45



480mm High Straight Acrylic						
VSDA215	2030	1998	x 30	x 480	£355	£61
VSDA205	2000	1968	x 30	x 480	£353	£61
VSDA185	1800	1768	x 30	x 480	£337	£61
VSDA175	1630	1598	x 30	x 480	£314	£61
VSDA165	1600	1568	x 30	x 480	£309	£61
VSDA145	1400	1368	x 30	x 480	£280	£61
VSDA125	1200	1168	x 30	x 480	£255	£61
VSDA105	1000	968	x 30	x 480	£227	£61
VSDA085	800	768	x 30	x 480	£200	£61
VSDA065	600	568	x 30	x 480	£185	£61



380/180mm High Wave Acrylic						
VSDA214W	2030	1998	x 30	x 380/180	£537	£45
VSDA204W	2000	1968	x 30	x 380/180	£534	£45
VSDA184W	1800	1768	x 30	x 380/180	£519	£45
VSDA174W	1630	1598	x 30	x 380/180	£507	£45
VSDA164W	1600	1568	x 30	x 380/180	£506	£45
VSDA144W	1400	1368	x 30	x 380/180	£492	£45
VSDA124W	1200	1168	x 30	x 380/180	£468	£45
VSDA104W	1000	968	x 30	x 380/180	£454	£45
VSDA084W	800	768	x 30	x 380/180	£428	£45



480/280mm High Wave Acrylic						
VSDA215W	2030	1998	x 30	x 480/280	£574	£61
VSDA205W	2000	1968	x 30	x 480/280	£568	£61
VSDA185W	1800	1768	x 30	x 480/280	£554	£61
VSDA175W	1630	1598	x 30	x 480/280	£538	£61
VSDA165W	1600	1568	x 30	x 480/280	£537	£61
VSDA145W	1400	1368	x 30	x 480/280	£519	£61
VSDA125W	1200	1168	x 30	x 480/280	£494	£61
VSDA105W	1000	968	x 30	x 480/280	£473	£61
VSDA085W	800	768	x 30	x 480/280	£443	£61

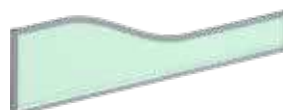

5 Year
Guarantee

GOF DESK MOUNTED SCREENS & PODS



Screens & Pods

Straight Acrylic Desk Mounted Screens

GOF DESK MOUNTED SCREENS & PODS

FIXING BRACKETS



Desk Mounted Screens fit all Gresham desk ranges and are inclusive of brackets. When ordering, suffix the screen code with bracket type.



How to specify -

- 1: Identify desk range
- 2: Select screen position (see diagrams)
- 3: Identify screen length & type
- 4: Add bracket suffix to screen code

Example of use -

1 1600 Deskit Workstation rear screen VSDf164-20

Screens & Pods

Bench² Access Top * Requires link post

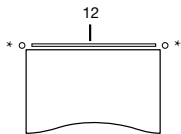

Bench² Scallop Top & DesQ * Requires link post If used with Bench² over desk shelving, please substitute -04 brackets with -14

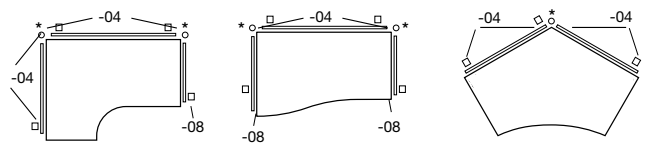

* Requires User Modification

Bench² Fixed Top * Requires link post

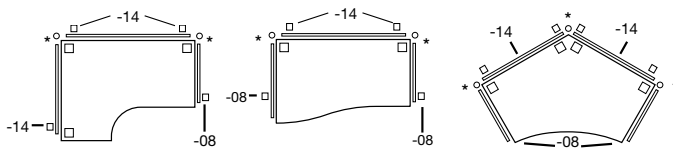

Mesa * Requires link post

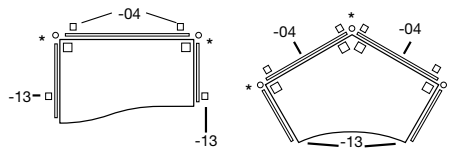

* Requires User Modification

EX10 Executive * Requires link post

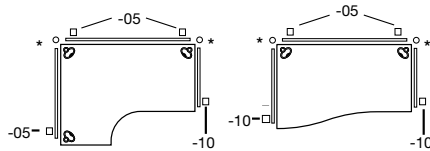

Deskit * Requires link post

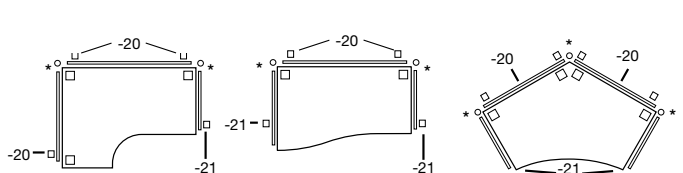

Desktop Screen Brackets

- 04 Mesa, Bench Scallop & DesQ configurations (supplied in pairs).
- 05 EX10 Executive configurations - Fits to port holes (supplied in pairs).
- 08 Bench² Fixed, Scallop Top & DesQ configurations - 1000 side - 800 sides (supplied singularly) - Jaw size 17mm - 32mm.
- 10 Can be used on any range (supplied singularly)
- 12 Bench² Access Top screen support rail - singular.
- 13 Mesa & Mesa Plus - 800 side & 600 return sides - (supplied singularly).
- 14 Bench² Fixed Top brackets - supplied in pairs.
- 20 Deskit configurations (supplied in pairs) - Jaw size 15mm - 30mm.
- 21 Deskit configurations - 1000, 800 & 600 Return screen for use on 25mm thick tops. Can only be used with rear screen and 4way post

Bracket Suffix Codes

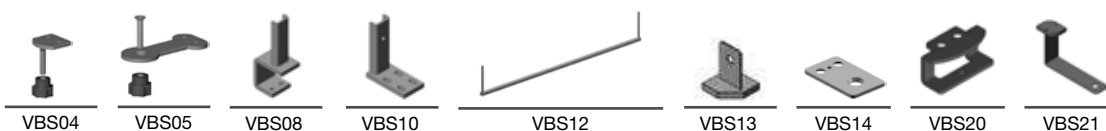

Code	Description	Price
4 Way Link Post Set		
VLP05	480mm high 4 way 90° linking set	£59
VLP04	380mm high 4 way 90° linking set	£57
VLP03	280mm high 4 way 90° linking set	£54
VLP02	180mm high 4 way 90° linking set	£48

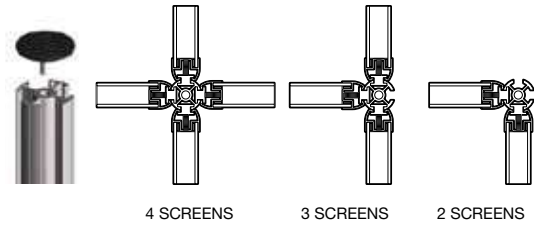

3 Way Link Post Set		
VLP05-3	480mm high 3 way 120° linking set	£59
VLP04-3	380mm high 3 way 120° linking set	£57
VLP03-3	280mm high 3 way 120° linking set	£54
VLP02-3	180mm high 3 way 120° linking set	£48

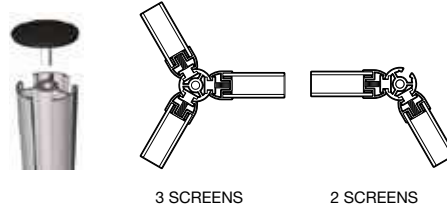

Link Infill Sets

Only required when linking floor standing to desk mounted screens on Deskit, EX10 Executive, Bench², Mesa and Mesa Plus.
Example of link infill usage.

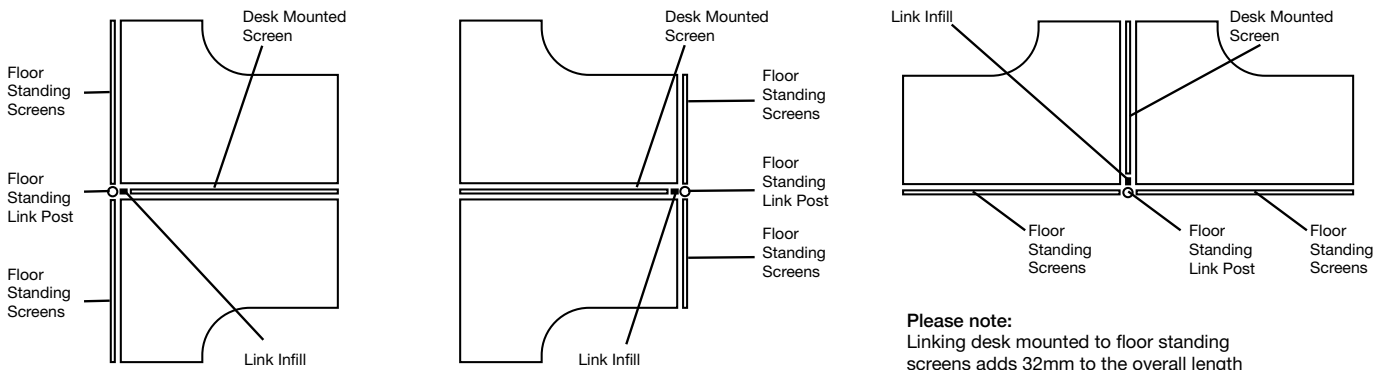

Please note:
Linking desk mounted to floor standing screens adds 32mm to the overall length of the floor standing screen run.

Desktop Screen to Floor Standing Screen Link infills

Code	Description	Price
VL103	280mm high link infill	£35
VL104	380mm high link infill	£35
VL105	480mm high link infill	£35



Screen to desk link bracket

Code	Description	Price
UNDSL	Links desks to floor standing screens	£15



GOF FLOOR STANDING SCREENS & PODS

5 Year
Guarantee

Floor standing screens match the construction and can be linked to desk mounted screens. They can be used to divide space in open plan areas.



- Available in straight and wave-topped options.
- Available in a selection of heights and widths.
- Aluminium frame includes integral tool-bar to top edge.
- Certain configurations may require link posts & stabiliser feet.

Screens & Pods

Code	W	D	H	Band 1	Band 2	Band 3
1000mm High Straight Fabric						
VSF1810	1800	x 30	x 1000	£427	£463	£518
VSF1710	1630	x 30	x 1000	£345	£363	£422
VSF1610	1600	x 30	x 1000	£340	£362	£421
VSF1410	1400	x 30	x 1000	£318	£345	£386
VSF1210	1200	x 30	x 1000	£301	£324	£364
VSF1010	1000	x 30	x 1000	£280	£305	£347
VSF0810	800	x 30	x 1000	£243	£255	£278
VSF0610	600	x 30	x 1000	£225	£250	£273



1100mm High Straight Fabric						
VSF1811	1800	x 30	x 1100	£444	£475	£533
VSF1711	1630	x 30	x 1100	£363	£389	£445
VSF1611	1600	x 30	x 1100	£362	£387	£443
VSF1411	1400	x 30	x 1100	£345	£363	£406
VSF1211	1200	x 30	x 1100	£319	£346	£387
VSF1011	1000	x 30	x 1100	£304	£326	£365
VSF0811	800	x 30	x 1100	£254	£269	£297
VSF0611	600	x 30	x 1100	£231	£258	£280



1200mm High Straight Fabric Additional toolbar at 1000mm high.						
VSF1812	1800	x 30	x 1200	£510	£548	£605
VSF1712	1630	x 30	x 1200	£471	£492	£550
VSF1612	1600	x 30	x 1200	£468	£490	£548
VSF1412	1400	x 30	x 1200	£437	£461	£503
VSF1212	1200	x 30	x 1200	£410	£433	£474
VSF1012	1000	x 30	x 1200	£386	£407	£446
VSF0812	800	x 30	x 1200	£301	£316	£341
VSF0612	600	x 30	x 1200	£270	£297	£319



1400mm High Straight Fabric Additional toolbar at 1000mm high.						
VSF1814	1800	x 30	x 1400	£539	£575	£632
VSF1714	1630	x 30	x 1400	£494	£522	£580
VSF1614	1600	x 30	x 1400	£490	£517	£575
VSF1414	1400	x 30	x 1400	£461	£490	£531
VSF1214	1200	x 30	x 1400	£429	£458	£500
VSF1014	1000	x 30	x 1400	£401	£429	£471
VSF0814	800	x 30	x 1400	£327	£346	£367
VSF0614	600	x 30	x 1400	£302	£326	£352



1600mm High Straight Fabric Additional toolbar at 1000mm high.						
VSF1816	1800	x 30	x 1600	£566	£600	£656
VSF1716	1630	x 30	x 1600	£544	£575	£632
VSF1616	1600	x 30	x 1600	£537	£568	£629
VSF1416	1400	x 30	x 1600	£506	£538	£580
VSF1216	1200	x 30	x 1600	£473	£506	£548
VSF1016	1000	x 30	x 1600	£443	£475	£517
VSF0816	800	x 30	x 1600	£353	£369	£395
VSF0616	600	x 30	x 1600	£324	£347	£369



1800mm High Straight Fabric Additional toolbar at 1000mm high.						
VSF1818	1800	x 30	x 1800	£624	£658	£718
VSF1718	1630	x 30	x 1800	£595	£631	£689
VSF1618	1600	x 30	x 1800	£592	£626	£683
VSF1418	1400	x 30	x 1800	£555	£592	£632
VSF1218	1200	x 30	x 1800	£518	£550	£592
VSF1018	1000	x 30	x 1800	£488	£517	£559
VSF0818	800	x 30	x 1800	£388	£409	£434
VSF0618	600	x 30	x 1800	£356	£373	£400



5 Year
Guarantee

GOF FLOOR STANDING SCREENS & PODS



Screens & Pods

1600mm High Straight Fabric Floor Standing Screens

GOF FLOOR STANDING SCREENS & PODS

5 Year
Guarantee

Floor standing screens are available in a selection of fabric finishes or can be specified in a combination of materials that suit user preferences.

- Available in a selection of heights and widths.
- Available in straight or wave-topped options.
- Aluminium frame includes integral tool-bar to top edge.
- Acrylic available in clear, frosted or a selection of colours - Specify at point of order.
- Certain configurations may require link posts & stabiliser feet.

Acrylic Options



S2 000 S2 030
Clear Polar Frost

Coloured Frosted Acrylic Options - Surcharge (More colours available, see Technical Information section).



S2 9T21 S2 4T50 S2 2T07 S2 7T1F S2 3T17 S2 6T21 S2 6T9A
Stone Chilli Red Citrus Azure Blue Mandarin Glacier Lime Zest
Grey Red Yellow Blue Orange Green Zest



Code	W	D	H	Band 1	Band 2	Band 3	Colour Surcharge		
1400mm High Part Glazed Straight Fabric/Acrylic									
Additional toolbar at 1000mm high.									
VSA1814	1800	x	30	x	1400	£693	£734	£795	£45
VSA1714	1630	x	30	x	1400	£594	£622	£677	£45
VSA1614	1600	x	30	x	1400	£592	£616	£675	£45
VSA1414	1400	x	30	x	1400	£563	£587	£630	£45
VSA1214	1200	x	30	x	1400	£537	£560	£601	£45
VSA1014	1000	x	30	x	1400	£442	£468	£508	£45
VSA0814	800	x	30	x	1400	£389	£406	£429	£45
VSA0614	600	x	30	x	1400	£337	£355	£379	£45



1600mm High Part Glazed Straight Fabric/Acrylic									
Additional toolbar at 1000mm high.									
VSA1816	1800	x	30	x	1600	£786	£827	£883	£61
VSA1716	1630	x	30	x	1600	£687	£714	£770	£61
VSA1616	1600	x	30	x	1600	£683	£713	£768	£61
VSA1416	1400	x	30	x	1600	£636	£681	£723	£61
VSA1216	1200	x	30	x	1600	£586	£655	£694	£61
VSA1016	1000	x	30	x	1600	£492	£518	£560	£61
VSA0816	800	x	30	x	1600	£443	£473	£498	£61
VSA0616	600	x	30	x	1600	£392	£422	£445	£61



1800mm High Part Glazed Straight Fabric/Acrylic									
Additional toolbar at 1000mm high.									
VSA1818	1800	x	30	x	1800	£881	£906	£968	£76
VSA1718	1630	x	30	x	1800	£758	£784	£839	£76
VSA1618	1600	x	30	x	1800	£756	£782	£838	£76
VSA1418	1400	x	30	x	1800	£709	£750	£790	£76
VSA1218	1200	x	30	x	1800	£636	£719	£758	£76
VSA1018	1000	x	30	x	1800	£544	£569	£611	£76
VSA0818	800	x	30	x	1800	£496	£518	£545	£76
VSA0618	600	x	30	x	1800	£432	£465	£490	£76



1400mm High Straight Fabric/Perforated Steel									
Additional toolbar at 1000mm high									
VSS1814	1800	x	30	x	1400	£667	£727	£784	-
VSS1714	1630	x	30	x	1400	£559	£584	£641	-
VSS1614	1600	x	30	x	1400	£551	£578	£636	-
VSS1414	1400	x	30	x	1400	£511	£539	£582	-
VSS1214	1200	x	30	x	1400	£476	£506	£548	-
VSS1014	1000	x	30	x	1400	£443	£469	£509	-
VSS0814	800	x	30	x	1400	£337	£353	£377	-
VSS0614	600	x	30	x	1400	£302	£314	£340	-



1600mm High Straight Fabric/Perforated Steel									
Additional toolbar at 1000mm high									
VSS1816	1800	x	30	x	1600	£719	£755	£810	-
VSS1716	1630	x	30	x	1600	£606	£632	£690	-
VSS1616	1600	x	30	x	1600	£600	£625	£681	-
VSS1416	1400	x	30	x	1600	£559	£584	£626	-
VSS1216	1200	x	30	x	1600	£517	£545	£584	-
VSS1016	1000	x	30	x	1600	£471	£494	£534	-
VSS0816	800	x	30	x	1600	£396	£413	£438	-
VSS0616	600	x	30	x	1600	£353	£364	£391	-



5 Year
Guarantee

GOF FLOOR STANDING SCREENS & PODS



Code W H

1800mm High Mobile Screens Fabric

VSFM1618	1600	x	1800
VSFM1418	1400	x	1800
VSFM1218	1200	x	1800

Band 1	Band 2	Band 3
£750	£790	£873
£743	£782	£824
£714	£753	£795

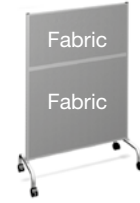

1800mm High Mobile Screens Fabric/MFC Wooden Panel

VSFMW1618	1600	x	1800
VSFMW1418	1400	x	1800
VSFMW1218	1200	x	1800

£790	£813	£893
£782	£806	£849
£753	£776	£819



Screens & Pods



1600mm High Straight Part Glazed Floor Standing Screens

GOF FLOOR STANDING SCREENS & PODS

5 Year
Guarantee

Floor standing screens match the construction and can be linked to desk mounted screens. They can be used to divide space in open plan areas.



- Available in straight and wave-topped options.
- Available in a selection of heights and widths.
- Aluminium frame includes integral tool-bar to top edge.
- Certain configurations may require link posts & stabiliser feet.

Screens & Pods

Code	W	D	H	Band 1	Band 2	Band 3
1100/900mm High Wave Fabric						
VSF1811W	1800	x 30	x 1100/900	£474	£509	£567
VSF1711W	1630	x 30	x 1100/900	£433	£457	£511
VSF1611W	1600	x 30	x 1100/900	£429	£453	£509
VSF1411W	1400	x 30	x 1100/900	£419	£444	£485
VSF1211W	1200	x 30	x 1100/900	£393	£419	£461
VSF1011W	1000	x 30	x 1100/900	£384	£406	£445
VSF0811W	800	x 30	x 1100/900	£338	£355	£379
1200/1000mm High Wave Fabric						
VSF1812W	1800	x 30	x 1200/1000	£494	£532	£591
VSF1712W	1630	x 30	x 1200/1000	£449	£476	£534
VSF1612W	1600	x 30	x 1200/1000	£446	£475	£533
VSF1412W	1400	x 30	x 1200/1000	£434	£463	£504
VSF1212W	1200	x 30	x 1200/1000	£413	£442	£482
VSF1012W	1000	x 30	x 1200/1000	£396	£425	£467
VSF0812W	800	x 30	x 1200/1000	£351	£388	£410
1400/1200mm High Wave Fabric Additional toolbar at 1000mm high.						
VSF1814W	1800	x 30	x 1400/1200	£578	£613	£673
VSF1714W	1630	x 30	x 1400/1200	£546	£575	£632
VSF1614W	1600	x 30	x 1400/1200	£544	£569	£630
VSF1414W	1400	x 30	x 1400/1200	£517	£548	£587
VSF1214W	1200	x 30	x 1400/1200	£485	£511	£554
VSF1014W	1000	x 30	x 1400/1200	£471	£498	£538
VSF0814W	800	x 30	x 1400/1200	£392	£410	£437
1600/1400mm High Wave Fabric Additional toolbar at 1000mm high.						
VSF1816W	1800	x 30	x 1600/1400	£603	£637	£694
VSF1716W	1630	x 30	x 1600/1400	£586	£618	£676
VSF1616W	1600	x 30	x 1600/1400	£580	£613	£673
VSF1416W	1400	x 30	x 1600/1400	£555	£587	£630
VSF1216W	1200	x 30	x 1600/1400	£522	£554	£595
VSF1016W	1000	x 30	x 1600/1400	£494	£530	£568
VSF0816W	800	x 30	x 1600/1400	£393	£419	£443
1800/1600mm High Wave Fabric Additional toolbar at 1000mm high.						
VSF1818W	1800	x 30	x 1800/1600	£662	£702	£760
VSF1718W	1630	x 30	x 1800/1600	£645	£683	£738
VSF1618W	1600	x 30	x 1800/1600	£637	£676	£733
VSF1418W	1400	x 30	x 1800/1600	£610	£649	£692
VSF1218W	1200	x 30	x 1800/1600	£575	£608	£648
VSF1018W	1000	x 30	x 1800/1600	£546	£576	£616
VSF0818W	800	x 30	x 1800/1600	£538	£563	£586



Code W D H

1400/1200mm High Part Glazed Wave Fabric/Acrylic
Additional toolbar at 1000mm high.

VSA1814W	1800	x	30	x	1400/1200
VSA1714W	1630	x	30	x	1400/1200
VSA1614W	1600	x	30	x	1400/1200
VSA1414W	1400	x	30	x	1400/1200
VSA1214W	1200	x	30	x	1400/1200
VSA1014W	1000	x	30	x	1400/1200
VSA0814W	800	x	30	x	1400/1200

1600/1400mm High Part Glazed Wave Fabric/Acrylic
Additional toolbar at 1000mm high.

VSA1816W	1800	x	30	x	1600/1400
VSA1716W	1630	x	30	x	1600/1400
VSA1616W	1600	x	30	x	1600/1400
VSA1416W	1400	x	30	x	1600/1400
VSA1216W	1200	x	30	x	1600/1400
VSA1016W	1000	x	30	x	1600/1400
VSA0816W	800	x	30	x	1600/1400

1800/1600mm High Part Glazed Wave Fabric/Acrylic
Additional toolbar at 1000mm high.

VSA1818W	1800	x	30	x	1800/1600
VSA1718W	1630	x	30	x	1800/1600
VSA1618W	1600	x	30	x	1800/1600
VSA1418W	1400	x	30	x	1800/1600
VSA1218W	1200	x	30	x	1800/1600
VSA1018W	1000	x	30	x	1800/1600
VSA0818W	800	x	30	x	1800/1600

1400/1200mm High Part Wave Fabric/Perforated Steel
Additional toolbar at 1000mm high.

VSS1814W	1800	x	30	x	1400/1200
VSS1714W	1630	x	30	x	1400/1200
VSS1614W	1600	x	30	x	1400/1200
VSS1414W	1400	x	30	x	1400/1200
VSS1214W	1200	x	30	x	1400/1200
VSS1014W	1000	x	30	x	1400/1200
VSS0814W	800	x	30	x	1400/1200

1600/1400mm High Part Wave Fabric/Perforated Steel
Additional toolbar at 1000mm high.

VSS1816W	1800	x	30	x	1600/1400
VSS1716W	1630	x	30	x	1600/1400
VSS1616W	1600	x	30	x	1600/1400
VSS1416W	1400	x	30	x	1600/1400
VSS1216W	1200	x	30	x	1600/1400
VSS1016W	1000	x	30	x	1600/1400
VSS0816W	800	x	30	x	1600/1400

Band 1	Band 2	Band 3	Colour Surcharge
£760	£798	£856	£45
£673	£693	£752	£45
£666	£690	£750	£45
£645	£673	£714	£45
£613	£638	£679	£45
£532	£555	£598	£45
£475	£491	£515	£45

£846	£871	£928	£61
£758	£784	£839	£61
£754	£781	£837	£61
£747	£758	£799	£61
£703	£731	£771	£61
£580	£608	£648	£61
£530	£566	£592	£61

£928	£983	£1,041	£76
£835	£885	£941	£76
£831	£881	£936	£76
£822	£867	£910	£76
£774	£823	£861	£76
£637	£676	£719	£76
£580	£616	£641	£76

£736	£776	£835	-
£642	£667	£725	-
£637	£664	£722	-
£606	£632	£674	-
£567	£593	£635	-
£538	£563	£603	-
£473	£488	£510	-

£792	£832	£890	-
£690	£718	£774	-
£683	£713	£768	-
£651	£677	£720	-
£608	£635	£675	-
£574	£600	£640	-
£538	£563	£587	-



MIRAGE TREES SCREENS & PODS



Inspired by the surrounding nature, our class A sound absorbing tree shaped panelled screens are perfect for any environment. When put together, the panels take on the shape of a forest: made even more realistic and evocative by the fact that the panels can be chosen in the typical colours of the leaves in spring, summer and autumn. Putting several panels together allows them to be used as a partition wall, to divide up - even on a temporary basis - work areas or dining areas, or to create genuinely private spaces in order to create small lounges or meeting rooms. Featuring an elegant design, a highly practical dividing function.

Product Features



Colour Options



Please Note:
TRE03 and TRE04 are only available in Inloom Sealife 6075 Fabric.

Screens & Pods



TRE01
Small Mirage Tree Screen

Height 1260mm
Width 990mm
Depth 295mm
Weight 8.0kg
Price £922



TRE02
Large Mirage Tree Screen

Height 1660mm
Width 990mm
Depth 295mm
Weight 9.5kg
Price £1,025



TRE03
Small Mirage Tree Screen
(Made from Recycled Bottles)

Height 1260mm
Width 990mm
Depth 295mm
Weight 8.0kg
Price £918



TRE04
Large Mirage Tree Screen
(Made from Recycled Bottles)

Height 1660mm
Width 990mm
Depth 295mm
Weight 9.5kg
Price £1,017



5 Year
Guarantee

NEW
PRODUCT

MIRAGE TREES SCREENS & PODS

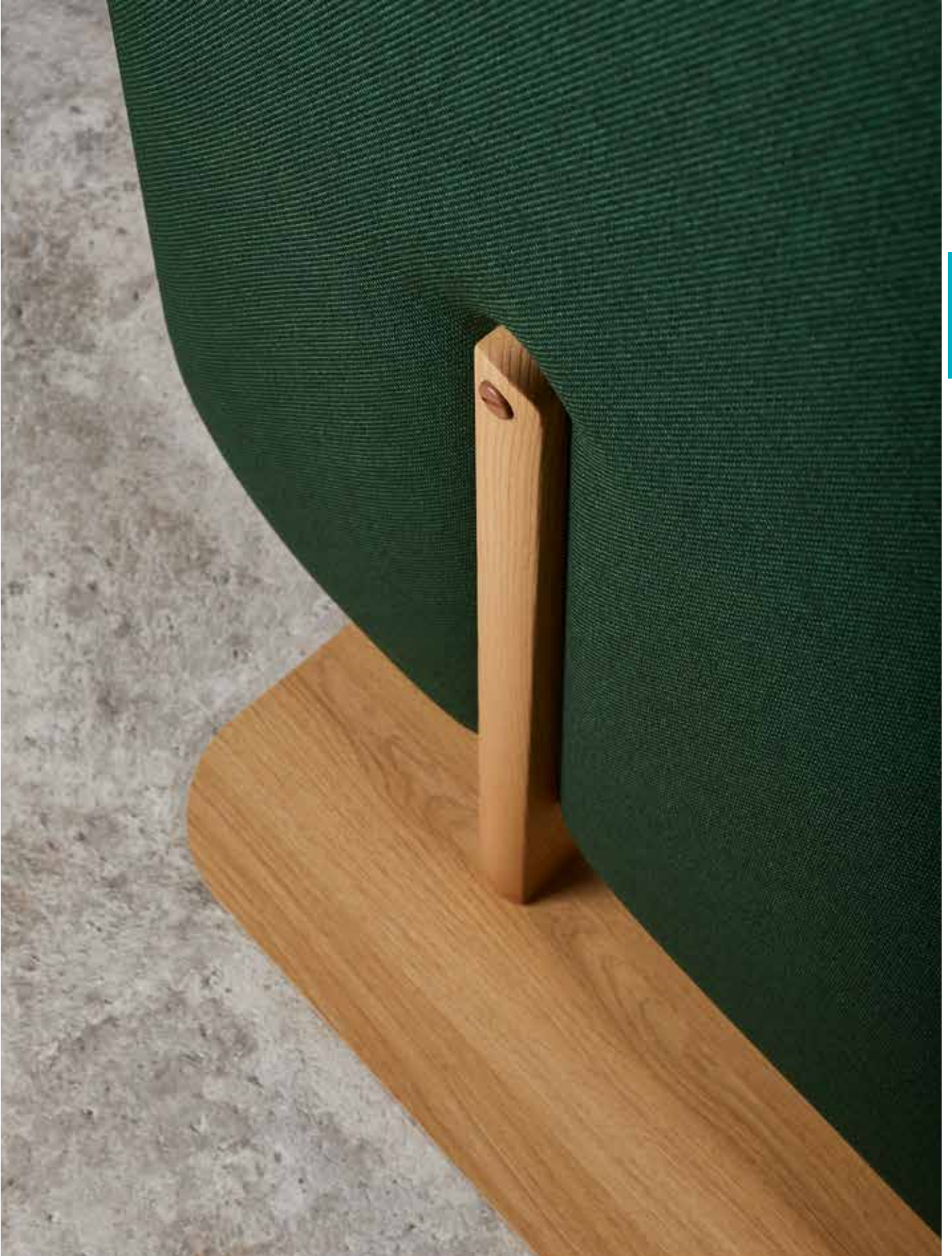

Screens & Pods

GOF PANELS

SCREENS & PODS

5 Year
Guarantee

Code	Where used	Price
------	------------	-------

1400mm Magnetic Dry Wipe Board

Fits into upper section of screen only, price is per side and additional to fabric screen, specify screen code with suffix.

-DB	To suit 1800 wide screens	£144
-DB	To suit 1630 wide screens	£134
-DB	To suit 1600 wide screens	£132
-DB	To suit 1400 wide screens	£113
-DB	To suit 1200 wide screens	£98
-DB	To suit 1000 wide screens	£78
-DB	To suit 800 wide screens	£54
-DB	To suit 600 wide screens	£48

Magnetic dry wipe board (-DB)

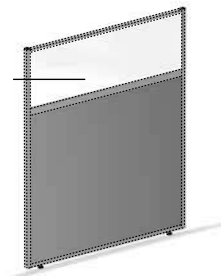

1600mm Magnetic Dry Wipe Board

Fits into upper section of screen only, price is per side and additional to fabric screen, specify screen code with suffix.

-DB	To suit 1800 wide screens	£202
-DB	To suit 1630 wide screens	£185
-DB	To suit 1600 wide screens	£180
-DB	To suit 1400 wide screens	£157
-DB	To suit 1200 wide screens	£139
-DB	To suit 1000 wide screens	£107
-DB	To suit 800 wide screens	£93
-DB	To suit 600 wide screens	£88

1800mm Magnetic Dry Wipe Board

Fits into upper section of screen only, price is per side and additional to fabric screen, specify screen code with suffix.

-DB	To suit 1800 wide screens	£287
-DB	To suit 1630 wide screens	£257
-DB	To suit 1600 wide screens	£250
-DB	To suit 1400 wide screens	£219
-DB	To suit 1200 wide screens	£193
-DB	To suit 1000 wide screens	£155
-DB	To suit 800 wide screens	£131
-DB	To suit 600 wide screens	£120

Steel Kick Plate

Price is per side and additional to fabric.

VSKP18	To suit 1800 wide screens	£54
VSKP17	To suit 1630 wide screens	£52
VSKP16	To suit 1600 wide screens	£52
VSKP14	To suit 1400 wide screens	£48
VSKP12	To suit 1200 wide screens	£44
VSKP10	To suit 1000 wide screens	£42
VSKP08	To suit 800 wide screens	£40
VSKP06	To suit 600 wide screens	£39

Steel kick plate

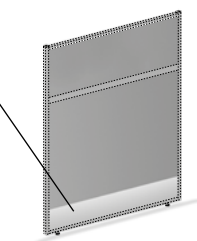

5 Year
Guarantee

GOF PANELS SCREENS & PODS

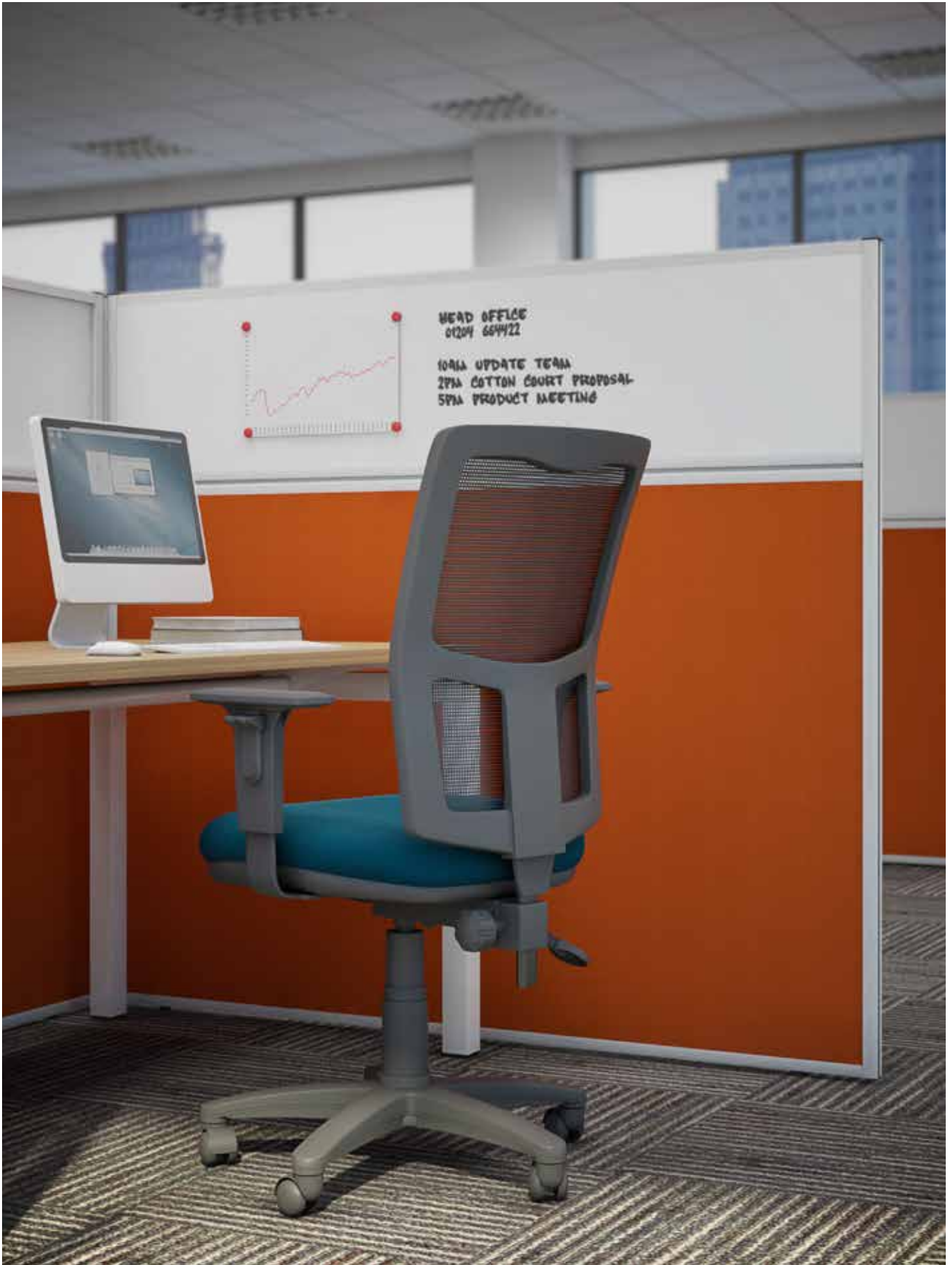

Screens & Pods

1400mm High Straight Fabric Floor Standing Screens with Magnetic Dry Wipe Board

GOF GOAL POST SCREENS & PODS

5 Year
Guarantee

Goal Post screens offer the advantages of standard floor standing screens whilst providing easy cable pass through from desk to desk beneath the worksurface.



- Available in a selection of heights and widths.
- Available in straight or wave-topped options.
- Can be linked directly to full panelled versions.
- Open section is 610mm high.

Screens & Pods

Code	W	D	H	Band 1	Band 2	Band 3
1000mm High Straight Fabric						
VSG1810	1800	x 30	x 1000	£319	£347	£403
VSG1710	1630	x 30	x 1000	£258	£277	£335
VSG1610	1600	x 30	x 1000	£255	£273	£331
VSG1410	1400	x 30	x 1000	£243	£258	£300
VSG1210	1200	x 30	x 1000	£225	£246	£287
VSG1010	1000	x 30	x 1000	£213	£227	£266
VSG0810	800	x 30	x 1000	£184	£192	£217
VSG0610	600	x 30	x 1000	£169	£180	£203



1100mm High Straight Fabric						
VSG1811	1800	x 30	x 1100	£331	£358	£415
VSG1711	1630	x 30	x 1100	£277	£294	£352
VSG1611	1600	x 30	x 1100	£273	£288	£347
VSG1411	1400	x 30	x 1100	£258	£277	£318
VSG1211	1200	x 30	x 1100	£245	£259	£301
VSG1011	1000	x 30	x 1100	£226	£246	£287
VSG0811	800	x 30	x 1100	£192	£200	£225
VSG0611	600	x 30	x 1100	£171	£185	£209



1200mm High Straight Fabric						
VSG1812	1800	x 30	x 1200	£387	£410	£469
VSG1712	1630	x 30	x 1200	£355	£369	£428
VSG1612	1600	x 30	x 1200	£351	£365	£425
VSG1412	1400	x 30	x 1200	£327	£346	£387
VSG1212	1200	x 30	x 1200	£308	£326	£365
VSG1012	1000	x 30	x 1200	£287	£306	£350
VSG0812	800	x 30	x 1200	£245	£258	£280
VSG0612	600	x 30	x 1200	£226	£242	£262



1400mm High Straight Fabric						
VSG1814	1800	x 30	x 1400	£406	£432	£490
VSG1714	1630	x 30	x 1400	£369	£392	£449
VSG1614	1600	x 30	x 1400	£365	£389	£445
VSG1414	1400	x 30	x 1400	£347	£365	£408
VSG1214	1200	x 30	x 1400	£322	£346	£387
VSG1014	1000	x 30	x 1400	£302	£322	£363
VSG0814	800	x 30	x 1400	£247	£261	£304
VSG0614	600	x 30	x 1400	£227	£246	£269



1600mm High Straight Fabric						
VSG1816	1800	x 30	x 1600	£456	£478	£538
VSG1716	1630	x 30	x 1600	£434	£463	£518
VSG1616	1600	x 30	x 1600	£429	£461	£511
VSG1416	1400	x 30	x 1600	£406	£432	£473
VSG1216	1200	x 30	x 1600	£379	£406	£445
VSG1016	1000	x 30	x 1600	£356	£382	£422
VSG0816	800	x 30	x 1600	£285	£299	£338
VSG0616	600	x 30	x 1600	£262	£277	£302



5 Year
Guarantee

GOF GOAL POST SCREENS & PODS

Code	W	D	H	Band 1	Band 2	Band 3
1100/900mm High Wave Fabric						
VSG1811W	1800	x 30	x 1100/900	£358	£386	£442
VSG1711W	1630	x 30	x 1100/900	£326	£342	£402
VSG1611W	1600	x 30	x 1100/900	£324	£341	£400
VSG1411W	1400	x 30	x 1100/900	£312	£335	£376
VSG1211W	1200	x 30	x 1100/900	£300	£312	£355
VSG1011W	1000	x 30	x 1100/900	£286	£305	£347
VSG0811W	800	x 30	x 1100/900	£255	£264	£291
1200/1000mm High Wave Fabric						
VSG1812W	1800	x 30	x 1200/1000	£372	£396	£456
VSG1712W	1630	x 30	x 1200/1000	£340	£360	£417
VSG1612W	1600	x 30	x 1200/1000	£338	£358	£413
VSG1412W	1400	x 30	x 1200/1000	£327	£347	£388
VSG1212W	1200	x 30	x 1200/1000	£309	£328	£369
VSG1012W	1000	x 30	x 1200/1000	£301	£318	£360
VSG0812W	800	x 30	x 1200/1000	£275	£304	£333
1400/1200mm High Wave Fabric						
VSG1814W	1800	x 30	x 1400/1200	£434	£463	£518
VSG1714W	1630	x 30	x 1400/1200	£409	£429	£488
VSG1614W	1600	x 30	x 1400/1200	£407	£427	£483
VSG1414W	1400	x 30	x 1400/1200	£389	£410	£453
VSG1214W	1200	x 30	x 1400/1200	£363	£388	£428
VSG1014W	1000	x 30	x 1400/1200	£355	£373	£415
VSG0814W	800	x 30	x 1400/1200	£297	£308	£333

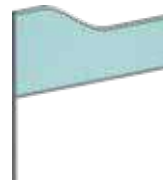
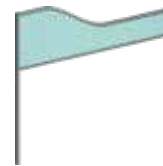
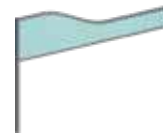

Screens & Pods



GOF FLOOR STANDING SCREENS & PODS

LINK POSTS & ACCESSORIES



Floor standing screens can be used to divide space in open plan areas. A selection of link posts and stabilising feet are available to aid stability.



- Screens can be linked together in straight lines as standard.
- Screens can be linked together at angles using link ports.
- Full, Half or Intermediate Feet can be specified where needed to avoid trip hazards.
- Available in colours matching screen metalwork.

Screens & Pods

4 Way Link Post Set - 90°

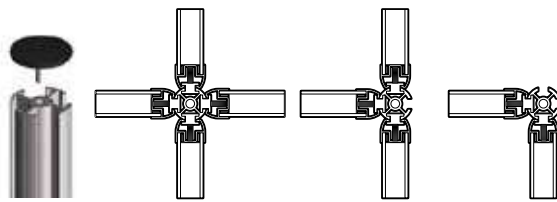

4 SCREENS 3 SCREENS 2 SCREENS

Code	For use with	Price
VLP18	1800mm high screen	£73
VLP16	1600mm high screen	£66
VLP14	1400mm high screen	£63
VLP12	1200mm high screen	£59
VLP11	1100mm high screen	£58
VLP10	1000mm high screen	£54

3 Way Link Post Set - 120°

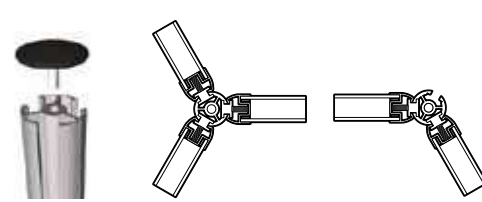

3 SCREENS 2 SCREENS

Code	For use with	Price
VLP18-3	1800mm high screen	£73
VLP16-3	1600mm high screen	£66
VLP14-3	1400mm high screen	£63
VLP12-3	1200mm high screen	£59
VLP11-3	1100mm high screen	£58
VLP10-3	1000mm high screen	£54

Screen Stabiliser Feet

Code	Description	Price
VSFHR	Right hand half foot	£71
VSFHL	Left hand half foot	£71
VSFF	Full foot	£71
VSFI	Round intermediate foot	£71

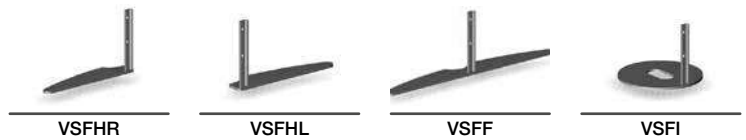

Screen Infill Strips

Available in Black, Grey or White.

Code	For use with	Price
VIS18	1800mm high screen	£6
VIS16	1600mm high screen	£6
VIS14	1400mm high screen	£6
VIS12	1200mm high screen	£6
VIS11	1100mm high screen	£6
VIS10	1000mm high screen	£6

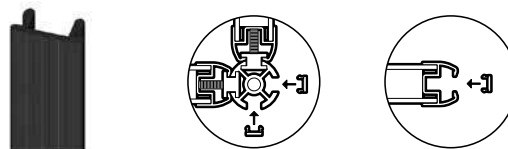

A4 trays - For use with screen tool bar -

Available in Black or Silver.

A4 Landscape	A4 Portrait	A4 Stationery tray
Code: VSTRA1 W: 395 D: 280 H: 62	Code: VSTRA2 W: 272 D: 350 H: 62	Code: VSTRA4 W: 388 D: 166 H: 95
Price: £62	Price: £64	Price: £100

Code	W	D	H	MFC Price
3rd level shelving - 25mm MFC Shelf				
Fits to floor standing screens				
VSW084	800	260	400	£102
VSW064	600	260	400	£96
VSW082	800	260	200	£102
VSW062	600	260	200	£96

Vision Panels - Fit to top of Straight Screens

Code	W	D	H	Price
------	---	---	---	-------

Wave Acrylic Vision Panel

Acrylic available in Clear or Frosted, specify at point of order.

VSGP12W	1200	x	5	x	400/200	£245
VSGP10W	1000	x	5	x	400/200	£226
VSGP08W	800	x	5	x	400/200	£200

Curved Acrylic Vision Panel

Acrylic available in Clear or Frosted, specify at point of order.

VSGP12C	1200	x	5	x	400/200	£245
VSGP10C	1000	x	5	x	400/200	£226
VSGP08C	800	x	5	x	400/200	£200



1600mm High Straight Part Glazed Floor Standing Screens

MESA PLUS SCREENS & PODS

SCREENS &
MODESTY PANELS

5 Year
Guarantee

Desk Mounted Screens (For Mesa Plus Desking only)



Fabric & Acrylic

Please specify fabric and acrylic choice.

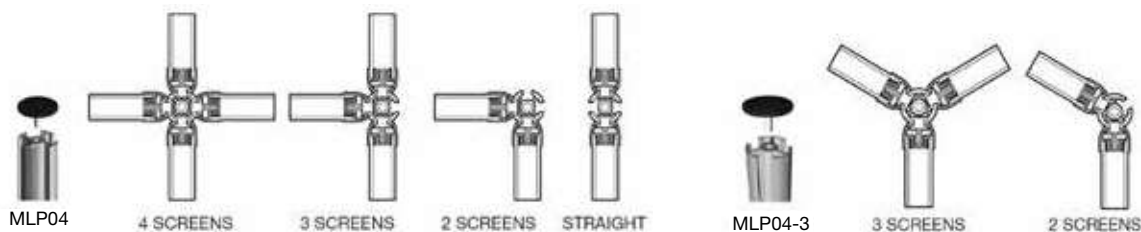

MLP04	4-Way Link Post Set	405mm high	£57
MLP04-3	3-Way Link Post Set	405mm high	£57

Code	Desk Size	W	D	H	Band 1	Band 2	Band 3
------	-----------	---	---	---	--------	--------	--------

Fabric Covered

Inclusive of fixing brackets. Requires Link Post at Joints.
Screens are 380h above desk.

MSDF204	2000	1968	30	405	£384	£402	£443
MSDF184	1800	1768	30	405	£346	£363	£406
MSDF164	1600	1568	30	405	£269	£285	£324
MSDF144	1400	1368	30	405	£227	£246	£287
MSDF124	1200	1168	30	405	£219	£235	£277
MSDF104	1000	968	30	405	£212	£225	£264
MSDF084	800	768	30	405	£193	£200	£243
MSRF084	800 Return Side	768	30	380	£193	£200	£243
MSRF064	600 Return Side	568	30	380	£187	£192	£231



Acrylic

Inclusive of fixing brackets. Requires Link Post at Joints.
Screens are 380h above desk.

Code	Desk Size	W	D	H	Clear or Frosted	Colours Surcharge
MSDA204	2000	1968	30	405	£308	£45
MSDA184	1800	1768	30	405	£294	£45
MSDA164	1600	1568	30	405	£270	£45
MSDA144	1400	1368	30	405	£250	£45
MSDA124	1200	1168	30	405	£225	£45
MSDA104	1000	968	30	405	£202	£45
MSDA084	800	768	30	405	£184	£45
MSRA084	800 Return Side	768	30	380	£184	£45
MSRA064	600 Return Side	568	30	380	£162	£45



Mesa Plus Rectangular Double Sided Desking with Mesa Plus Fabric Desk Mounted Screen



MIRAGE LITE SCREENS & PODS

Mirage Lite is a 28mm thick, non-pinnable frameless desk top screen system that is designed to fit to Gresham 25mm thick worksurfaces. The range is available in five distinct profile shapes and all screens are supplied with brackets that allow them to be simply fitted into place.

These slim-line screens can be upholstered in a choice of vibrant fabrics that not only help to delineate user space but also can add colour highlights in modern workspace environments. Tackable versions are available for a surcharge.

Additional Information:

- Frameless design.
- 28mm thick frameless upholstered screens.
- Brackets available in Black, Grey, Silver or White.
- Available in five unique designs.
- Fit to front/rear edge of desks/workstations.
- **Note 'Arrow' screens do not fit on Bench Desk (BK).**
- For Tackable version, please prefix T onto front of code *i.e* TML1804-2/1. Surcharge £87 per screen.

SCREEN OPTIONS

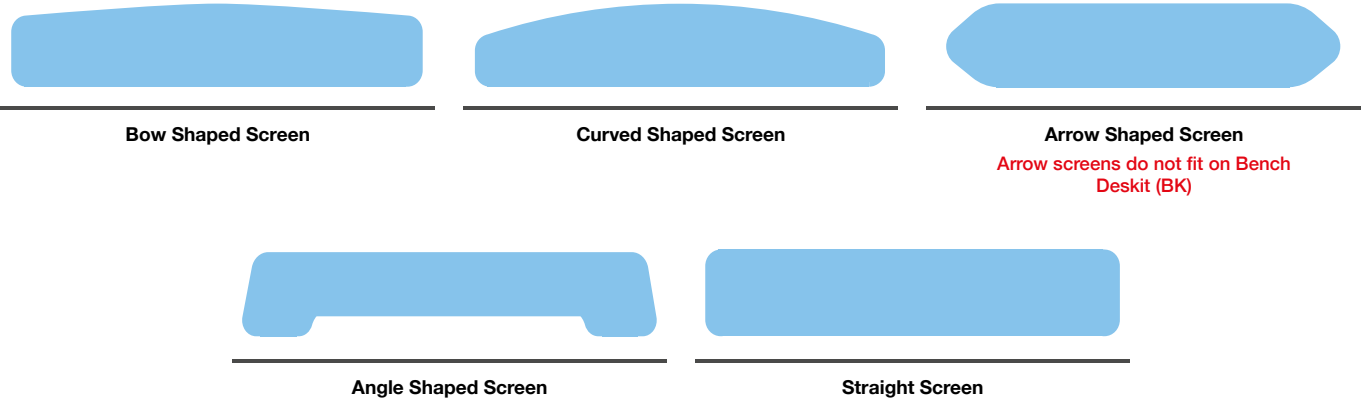

Screens & Pods

MIRAGE LITE FABRIC OPTIONS

<p>Band A Camira Cara</p>	<p>Band B Camira Lucia Camira Sonus Camira Carlow Camira Gravity Inloom Erika Inloom Alba Inloom Bondai</p>	<p>Band C Camira Patina Camira X2 Camira Aspect Camira Extreme Agua Chea Agua Task</p>	<p>Band D Camira Blazer Lite Camira Nexus</p>	<p>Band E Camira Blazer Camira Synergy Camira Aquarius Agua Lavoro Agua Buro Inloom Bioactive Inloom Roccia Inloom One Camira Oxygen Camira Quest</p>
--------------------------------------	--	---	--	--



Bow Shaped Screen on Bench Desk

MIRAGE LITE SCREENS & PODS

5 Year
Guarantee

Code	Description	Band A	Band B	Band C	Band D	Band E
Bow Shaped Screens						
ML2004-1	1970w x 380h x 28	£262	£343	£443	£511	£676
ML1804-1	1770w x 380h x 28	£244	£308	£387	£444	£575
ML1604-1	1570w x 380h x 28	£209	£242	£352	£402	£508
ML1404-1	1370w x 380h x 28	£204	£236	£312	£362	£438
ML1204-1	1170w x 380h x 28	£199	£232	£270	£299	£367
ML1004-1	970w x 380h x 28	£197	£230	£266	£294	£364
ML0804-1	770w x 380h x 28	£186	£220	£258	£284	£353
Curved Shaped Screens						
ML2004-2	1970w x 380h x 28	£262	£343	£443	£511	£676
ML1804-2	1770w x 380h x 28	£244	£308	£387	£444	£575
ML1604-2	1570w x 380h x 28	£209	£242	£352	£402	£508
ML1404-2	1370w x 380h x 28	£204	£236	£312	£362	£438
ML1204-2	1170w x 380h x 28	£199	£232	£270	£299	£367
ML1004-2	970w x 380h x 28	£197	£230	£266	£294	£364
ML0804-2	770w x 380h x 28	£186	£220	£258	£284	£353
Arrow Shaped Screens						
ML2004-6*	1970w x 380h x 28	£262	£343	£443	£511	£676
ML1804-6*	1770w x 380h x 28	£244	£308	£387	£444	£575
ML1604-6*	1570w x 380h x 28	£209	£242	£352	£402	£508
ML1404-6*	1370w x 380h x 28	£204	£236	£312	£362	£438
ML1204-6*	1170w x 380h x 28	£199	£232	£270	£299	£367
ML1004-6*	970w x 380h x 28	£197	£230	£266	£294	£364
ML0804-6*	770w x 380h x 28	£186	£220	£258	£284	£353
Angled Shaped Screens						
ML2004-9	1970w x 380h x 28	£300	£394	£478	£550	£729
ML1804-9	1770w x 380h x 28	£277	£352	£422	£476	£618
ML1604-9	1570w x 380h x 28	£241	£279	£379	£419	£542
ML1404-9	1370w x 380h x 28	£235	£275	£343	£373	£475
ML1204-9	1170w x 380h x 28	£226	£264	£297	£326	£400
ML1004-9	970w x 380h x 28	£223	£262	£293	£323	£395
Straight Screens						
ML2004-10	1970w x 380h x 28	£262	£343	£443	£511	£676
ML1804-10	1770w x 380h x 28	£244	£308	£387	£444	£575
ML1604-10	1570w x 380h x 28	£209	£242	£352	£402	£508
ML1404-10	1370w x 380h x 28	£204	£236	£312	£362	£438
ML1204-10	1170w x 380h x 28	£199	£232	£270	£299	£367
ML1004-10	970w x 380h x 28	£197	£230	£266	£294	£364
ML0804-10	770w x 380h x 28	£186	£220	£258	£284	£353

* Do not fit to Bench Deskit (BK) desks/workstations. All prices shown include brackets



Curved Shaped Screen on Design 2000 Deskit

FIXING BRACKETS

Please note certain configurations may result in the desk top screen being positioned 'off centre'.

Screen brackets are for front/rear of desks only. Brackets available in Silver, White, Black or Grey.

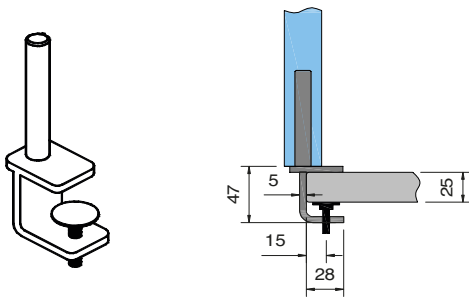

Usable jaw size of 17-33mm

Type /1 – 25mm clamp brackets (pair)

For use on the following:

- Deskit
- Bench² Fixed Top (Single Sided)
- Bench² Scallop Top (Single Sided)
- Rise & Rise LT
- D3K Fully Welded
- D2000 Fully Welded

Suffix screen code with /1

Example of code = ML1604-10/1

(Mirage Lite 1570 x 380 Straight Screen with Type 1 brackets)

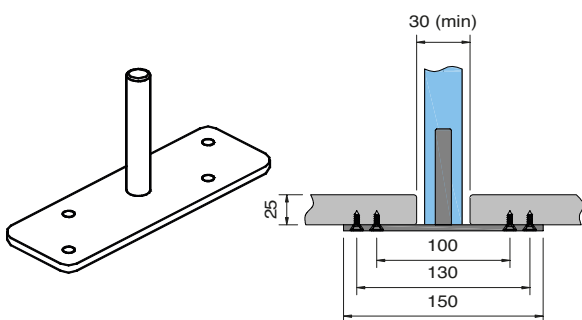

Minimum gap of 30mm between tops required

Type /2 – back to back bench bracket (pair)

Screw fixings supplied

For use on the following:

- Mesa Plus (Double Sided)

Suffix screen code with /2

Example of code = TML1404-1/2

(Mirage Lite 1370 x 380 Arrow Tackable Screen with Type 2 brackets)

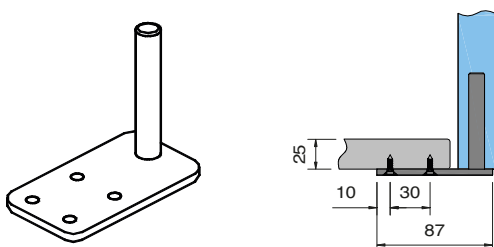
**Type /3 – single sided bench bracket (pair)**

Screw fixings supplied

For use on the following:

- Mesa Plus (Single Sided)

Suffix screen code with /3

Example of code = ML1804-6/3

(Mirage Lite 1770 x 380 Bow Screen with Type 3 brackets)

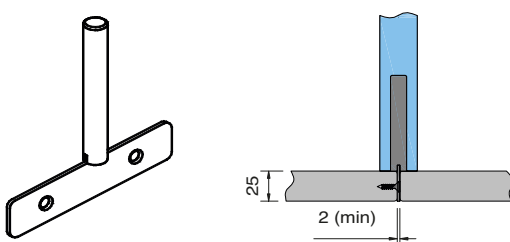

Minimum gap of 2mm between tops required

Type /4 – Slim bracket (pair)

Screw fixings supplied

For use on the following:

- Bench² Fixed Top (Double Sided)
- Bench² Scallop Top (Double Sided)

Suffix screen code with /4

Example of code = TML1604-2/4

(Mirage Lite 1570 x 380 Curved Tackable Screen with Type 4 brackets)

RETURN DESKTOP SCREENS

The Mirage Lite Return Screen is designed as an interference fit, so it can be installed and removed several times on a desk top as standard. A metal bracket fixed into the jaw is shaped to contact the desktop at a single point. The bracket creates an undersized gap, but flexes to ensure tight fitting. The second contact point is from the wooden jaw of the screen, this is not structural, just offering some stability. The bracket after time may be pushed down past its elastic point, and could require a slight adjustment back into its original shape to reinstate a tight fit, a gentle pull upwards should achieve this. The screens are designed only as a partition, not a location for accessories to be fitted. They are designed only to support the mass and forces of the screen itself, not anything additional such as people leaning, pushing or twisting once in situ.



Screens & Pods

Code	Description
Xtreme	
Return Screens	
ML1004-R	Return Desk Top Screen 1000w x 380h x 28
ML0804-R	Return Desk Top Screen 800w x 380h x 28
ML0604-R	Return Desk Top Screen 600w x 380h x 28

Band A	Band B	Band C	Band D	Band E
£301	£341	£369	£435	£495
£287	£324	£355	£372	£483
£272	£307	£342	£355	£370

Please Note:
Return Screens may need to be positioned to avoid End Frames and Pedestals.
Tackable versions are not available on return screens.

SCREEN POSITIONING

When ordering screens, ensure you know where they will be positioned so that the correct screen can be specified. Standard Rear Screens are supplied with brackets, whilst Return Screens are fitted with spring clips.

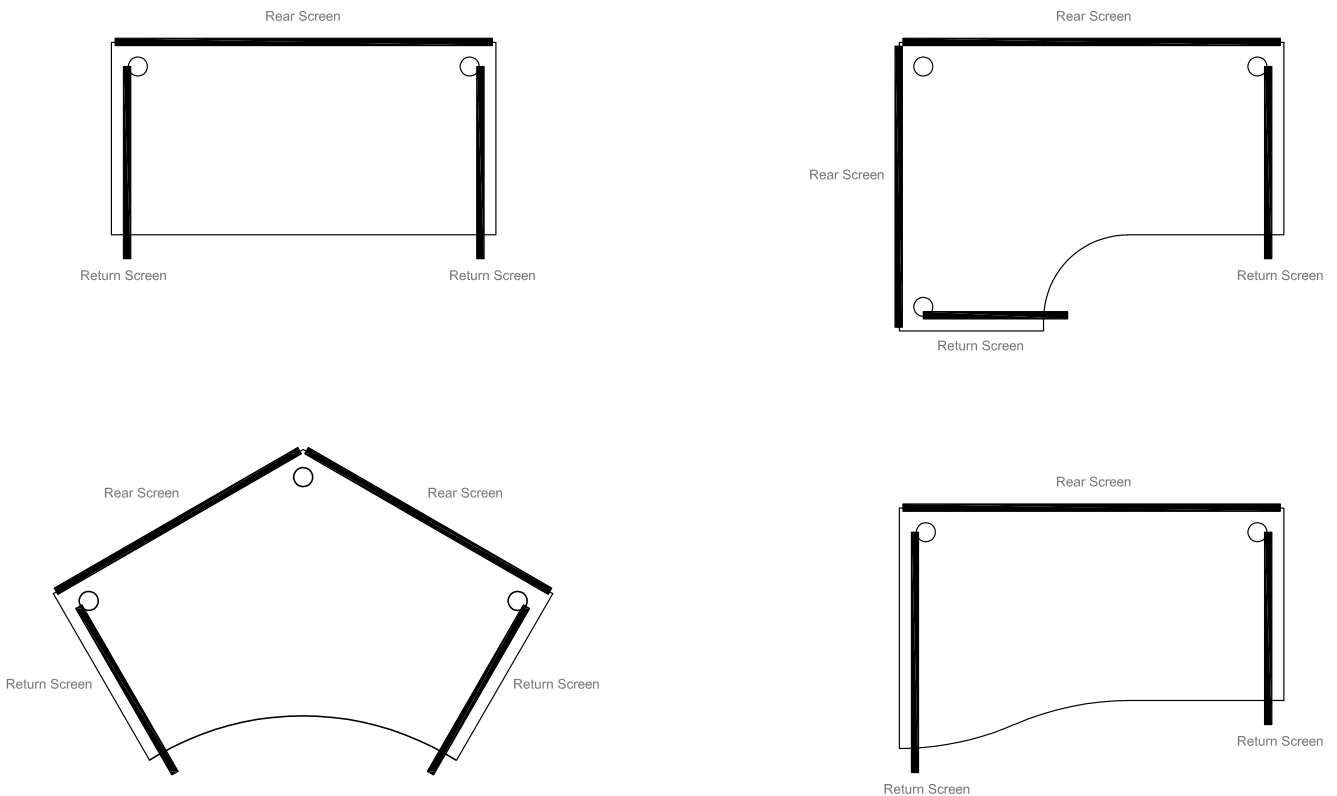



GE6 Mobile Screens Grey GE6 – Camira Synergy Mix, Synergy Partner, Synergy Serendipity (Band 3) Return Desktop Screens Camira Lucia Appledoore

GE ACOUSTICS SCREENS & PODS

5 Year
Guarantee

The workplace and the way we work are constantly evolving. We are continually required to create new spaces within existing environments with an increasing demand on sound absorbency. To meet this demand, Gresham Acoustics are available as a sound absorbing wall or ceiling mounted tile.

The hand crafted nature of the manufacturing of Acoustics allows any shape or size to be created, leaving no limitation to the product, only your imagination. This flexibility is embedded within the product in all forms including size, thickness, shape, fabrics and uses, all of which can be tailored to your exact requirements.

With limited floor space available in offices, empty walls or vertical surfaces can be used to absorb unwanted noise to help staff concentrate. Wall tiles, colours, patterns, texture, shape and tessellation can be introduced to otherwise plain and commonly white spaces while providing the dual function of sound absorption. Consider covering not just walls, but cupboard backs, doors and pillars.



Screens & Pods

Code	Thickness	Height	Width	Price	Camira: Cara	Camira: Rivet, Carlow	Camira: Blazer, Blazer Lite, Synergy, Sonus, Agua Buro, Inloom Jet Bioactive, Inloom One, Inloom Roccia		
Clouds									
Ceiling hung - Can be hung horizontally on most ceilings. A variety of fixings are available to connect the tiles to the ceilings, with steel cable kits provided as standard.									
GE11A1	40	x	820	x	1030	x	£509	£542	£626
GE11A2	65	x	820	x	1030	x	£537	£569	£652
GE11B1	40	x	920	x	1300	x	£567	£649	£815
GE11B2	65	x	920	x	1300	x	£615	£697	£862

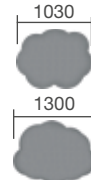

Code	Thickness	Diameter	Price			
Circles & Doughnuts						
Ceiling hung - Can be hung horizontally on most ceilings. A variety of fixings are available to connect the tiles to the ceilings, with steel cable kits provided as standard.						
GE12A1	40	x	500	£351	£361	£440
GE12A2	65	x	500	£391	£402	£498
GE12B1	40	x	750	£432	£464	£539
GE12B2	65	x	750	£489	£526	£622
GE12C1	40	x	1000	£461	£516	£655
GE12C2	65	x	1000	£500	£553	£693
GE13A1	40	x	500/250	£463	£472	£551
GE13A2	65	x	500/250	£503	£511	£609
GE13B1	40	x	750/500	£544	£575	£652
GE13B2	65	x	750/500	£601	£638	£734
GE13C1	40	x	1000/750	£574	£627	£767
GE13C2	65	x	1000/750	£611	£666	£805



Additional Information

Hanging Wire supplied as standard (see picture below)

⚠ If installing on suspended ceiling, verify load capacity prior to installation.



Suspended Ceiling Grid Clip

GECLIP To Suit 15mm Grid Ceilings £49 Per Tile
GECLIP To Suit 24/25mm Grid Ceilings £49 Per Tile

Code	Thickness	Height	Width	Price
------	-----------	--------	-------	-------

Square Ceiling Grid

Ceiling hung - Can be hung horizontally on most ceiling grid systems. No fixings required, the lip around the edge of the tile slots into existing ceiling grid.

GE25A1	40	x	595	x	595
--------	----	---	-----	---	-----



Additional Information

Tile rests on supports. No additional fixings necessary.

⚠ If installing on suspended ceiling, verify load capacity prior to installation.



Code	Thickness	Height	Width	Price	Camira: Blazer, Blazer Lite, Synergy, Sonus, Agua Buro, Inloom Jet Bioactive, Inloom Roccia, Inloom One			
Square								
Wall hung - Can be hung vertically or at angles on most walls. A variety of fixings are available to connect the tiles to the walls.								
GE14A1	40	x	600	x	600	£199	£225	£288
GE14A2	65	x	600	x	600	£221	£243	£319
GE14B1	40	x	800	x	800	£273	£314	£421
GE14B2	65	x	800	x	800	£301	£342	£448
GE14C1	40	x	1000	x	1000	£326	£387	£548
GE14C2	65	x	1000	x	1000	£370	£431	£592
GE14D1	40	x	1200	x	1200	£361	£423	£582
GE14D2	65	x	1200	x	1200	£424	£487	£645
Rectangle								
GE15A1	40	x		x	1000	£179	£196	£235
GE15A2	65	x		x	1000	£192	£208	£249
GE15B1	40	x		x	1200	£184	£199	£242
GE15B2	65	x	400	x	1200	£200	£217	£258
GE15C1	40	x		x	1400	£188	£274	£396
GE15C2	65	x		x	1400	£208	£292	£417
GE15D1	40	x		x	1600	£193	£314	£471
GE15D2	65	x		x	1600	£215	£335	£491
GE15E1	40	x		x	1000	£223	£255	£337
GE15E2	65	x		x	1000	£249	£280	£364
GE15F1	40	x		x	1200	£231	£263	£347
GE15F2	65	x	800	x	1200	£264	£331	£456
GE15G1	40	x		x	1400	£300	£382	£508
GE15G2	65	x		x	1400	£343	£388	£548
GE15H1	40	x		x	1600	£333	£380	£519
GE15H2	65	x		x	1600	£349	£396	£564
GE15J1	40	x		x	1000	£340	£370	£465
GE15J2	65	x		x	1000	£382	£394	£477
GE15K1	40	x	1000	x	1200	£345	£376	£526
GE15K2	65	x	1000	x	1200	£392	£408	£574
GE15L1	40	x		x	1400	£361	£391	£538
GE15L2	65	x		x	1400	£404	£428	£594



Apex

Wall hung. A variety of fixings are available to connect the tiles to the walls.

*prices shown are for single colour fabrics only

GE16A1			500	x	500	£333	£351	£392
GE16B1	120	x	700	x	700	POA	POA	POA
GE24A1			500	x	500	£333	£351	£392
GE24B1	120	x	700	x	700	POA	POA	POA
GE18A1			500	x	500	£333	£351	£392
GE18B1	120	x	700	x	700	POA	POA	POA



Arrow

Wall hung - Can be hung vertically or at angles on most walls. A variety of fixings are available to connect the tiles to the walls, with Velcro provided as standard.

GE19A1	40	x	500	x	500	£205	£219	£311
GE19A21	65	x	500	x	500	£241	£254	£341



Hexagon

Wall hung - Can be hung vertically or at angles on most walls. A variety of fixings are available to connect the tiles to the walls.

GE20A1	40	x	433	x	500	£179	£187	£265
GE20A2	65	x	433	x	500	£218	£229	£324
GE20B1	40	x	606	x	700	£261	£290	£370
GE20B2	65	x	606	x	700	£319	£355	£450
GE20C1	40	x	779	x	900	£279	£321	£427
GE20C2	65	x	779	x	900	£335	£395	£555



Additional Information
Velcro Strips supplied as standard.

BARRIER SCREENS

SCREENS & PODS

Specification

- 5mm free standing clear acrylic protection screens
- 8mm clear acrylic feet for stability
- Clear finish only

Code	Description	Price
Fully Glazed Free Standing Screen - 975mm w x 725mm h		
SNS250	Fully Glazed Screen with 250mm X 50mm Cut-out	£203
SNS300	Fully Glazed Screen with 300mm X 50mm Cut-out	£203
SNS350	Fully Glazed Screen with 350mm X 50mm Cut-out	£203

Other sizes available on request

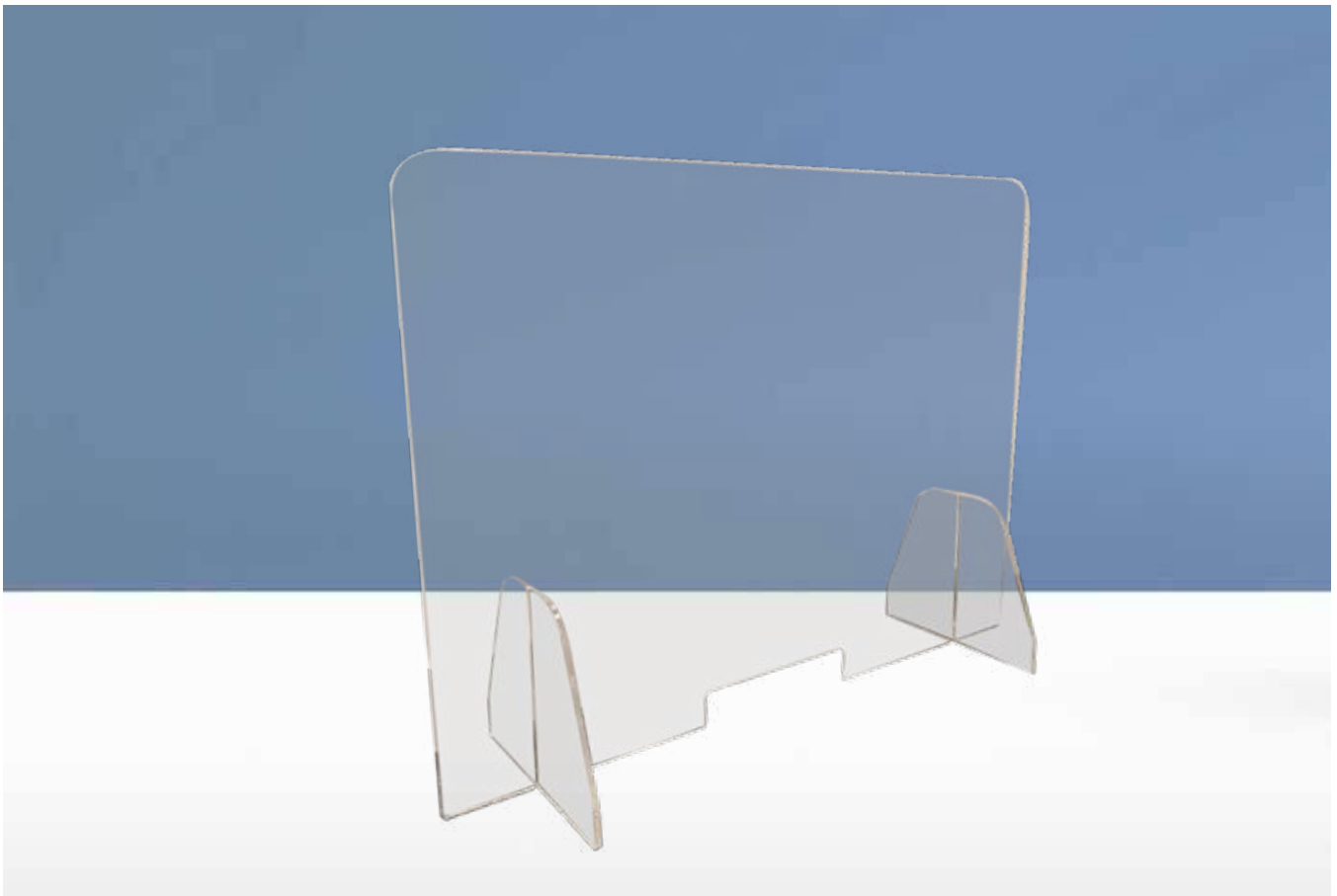

FITS TO DESKTOP SCREEN

* New Design (now finish size)

Specification

- 5mm thick
- Clear acrylic, easily cleanable
- Supplied with 2 x fixing brackets
- Can be added to GOF desk mounted screens and Mirage Lite Straight screens
- Edges are diamond polished with all sharp corners removed

GLAZED VISION PANELS SCREENS & PODS

Acrylic Options -

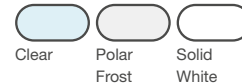

Solid White is a surcharge +25%

Bracket -



For GOF vision panels brackets suffix code with -VP (e.g. VS185S-VP) 10 - 38mm Adjustment

Code	Description (finish size)	Price
300mm High		
VS063S	Fully Glazed Vision Panel 600W X 300H	£159
VS083S	Fully Glazed Vision Panel 800W X 300H	£179
VS103S	Fully Glazed Vision Panel 1000W X 300H	£193
VS123S	Fully Glazed Vision Panel 1200W X 300H	£211
VS143S	Fully Glazed Vision Panel 1400W X 300H	£229
VS163S	Fully Glazed Vision Panel 1600W X 300H	£248
VS183S	Fully Glazed Vision Panel 1800W X 300H	£264
500mm High		
VS065S	Fully Glazed Vision Panel 600W X 500H	£185
VS085S	Fully Glazed Vision Panel 800W X 500H	£223
VS105S	Fully Glazed Vision Panel 1000W X 500H	£255
VS125S	Fully Glazed Vision Panel 1200W X 500H	£290
VS145S	Fully Glazed Vision Panel 1400W X 500H	£324
VS165S	Fully Glazed Vision Panel 1600W X 500H	£363
VS185S	Fully Glazed Vision Panel 1800W X 500H	£400



FREE STANDING DESKTOP SCREENS

SCREENS & PODS

Specification

- 5mm thick
- Clear acrylic, easily cleanable
- Supplied with 2 x fixing brackets
- Can be used as stand-alone screens
- Edges are diamond polished with all sharp corners removed
- Optional cut-out size 300mm X 100mm

Acrylic Options -



Solid White is a surcharge +25%

Code	Code with Cut Out	Description (finish size)	Price
600mm High			
FS0606	N/A	Fully Glazed Screen 600W X 600H	£198
FS0608	N/A	Fully Glazed Screen 800W X 600H	£229
FS0610	FS0610C	Fully Glazed Screen 1000W X 600H	£261
FS0612	FS0612C	Fully Glazed Screen 1200W X 600H	£287
FS0614	FS0614C	Fully Glazed Screen 1400W X 600H	£312
FS0616	FS0616C	Fully Glazed Screen 1600W X 600H	£345
FS0618	FS0618C	Fully Glazed Screen 1800W X 600H	£376
800mm High			
FS0806	N/A	Fully Glazed Screen 600W X 800H	£227
FS0808	N/A	Fully Glazed Screen 800W X 800H	£264
FS0810	FS0810C	Fully Glazed Screen 1000W X 800H	£304
FS0812	FS0812C	Fully Glazed Screen 1200W X 800H	£338
FS0814	FS0814C	Fully Glazed Screen 1400W X 800H	£373
FS0816	FS0816C	Fully Glazed Screen 1600W X 800H	£402
FS0818	FS0818C	Fully Glazed Screen 1800W X 800H	£433
1100mm High			
FS1106	N/A	Fully Glazed Screen 600W X 1100H	£255
FS1108	N/A	Fully Glazed Screen 800W X 1100H	£300
FS1110	FS1110C	Fully Glazed Screen 1000W X 1100H	£345
FS1112	FS1112C	Fully Glazed Screen 1200W X 1100H	£388
FS1114	FS1114C	Fully Glazed Screen 1400W X 1100H	£433
FS1116	FS1116C	Fully Glazed Screen 1600W X 1100H	£463
FS1118	FS1118C	Fully Glazed Screen 1800W X 1100H	£496



SCREEN BRACKETS & ACCESSORIES

SCREENS & PODS

Specification

*Please note brackets will increase in height when used with 1100h screens

- Brackets for a range of uses
- Cat flap
- Hinge brackets, fixed brackets and more



Fixed Bracket

Fixed screen brackets must be screw fixed for stability - supplied in pairs

For screen with fixed bracket panels suffix code with -FP (e.g. FS0618C-FP)



Free standing Bracket

Free standing bracket for sitting onto desktop (can be screw fixed for stability) - supplied in pairs.

For screen with free standing bracket panels suffix code with -FS (e.g. FS0618C-FS)



Clamp Bracket

Clamp bracket to suit rear of desktop (suit 25mm top panel) - supplied in pairs

For screen with clamp bracket panels suffix code with -CB (e.g. FS0618C-CB)



Divider Bracket ***Please note £26 net Surcharge***

Clamp bracket to suit side of desk/table (Adjustable from 25mm - 75mm) - supplied in pairs

For screen with divider bracket panels suffix code with -DB (e.g. FS0618C-DB)



Cat Flap ****Please note £63 net each****
Swing open cat flap to bottom of screen



Hinges ****Please note £5 net each****
90°, 4 way, 3 way (left to right)

CLUSTER SCREENS

SCREENS & PODS

Specification

- 5mm thick
- Clear acrylic, easily cleanable
- Stand alone screen
- Return screens
- Supplied with bracket for fixing on return screens
- Adjustable bracket along void

Acrylic Options -



Solid White is a surcharge
+25%

Screens & Pods

Code	Description (finish size)	Price
600mm High With 600mm Deep Return		
FSRS06606	600W X 600H Rear Screen with 600D X 600H Return	£465
FSRS08606	800W X 600H Rear Screen with 600D X 600H Return	£490
FSRS10606	1000W X 600H Rear Screen with 600D X 600H Return	£520
FSRS12606	1200W X 600H Rear Screen with 600D X 600H Return	£539
FSRS14606	1400W X 600H Rear Screen with 600D X 600H Return	£566
FSRS16606	1600W X 600H Rear Screen with 600D X 600H Return	£592
600mm High With 800mm Deep Return		
FSRS06608	600W X 600H Rear Screen with 800D X 600H Return	£530
FSRS08608	800W X 600H Rear Screen with 800D X 600H Return	£553
FSRS10608	1000W X 600H Rear Screen with 800D X 600H Return	£584
FSRS12608	1200W X 600H Rear Screen with 800D X 600H Return	£605
FSRS14608	1400W X 600H Rear Screen with 800D X 600H Return	£630
FSRS16608	1600W X 600H Rear Screen with 800D X 600H Return	£655
600mm High With 1000mm Deep Return		
FSRS06610	600W X 600H Rear Screen with 1000D X 600H Return	£593
FSRS08610	800W X 600H Rear Screen with 1000D X 600H Return	£617
FSRS10610	1000W X 600H Rear Screen with 1000D X 600H Return	£648
FSRS12610	1200W X 600H Rear Screen with 1000D X 600H Return	£668
FSRS14610	1400W X 600H Rear Screen with 1000D X 600H Return	£693
FSRS16610	1600W X 600H Rear Screen with 1000D X 600H Return	£719

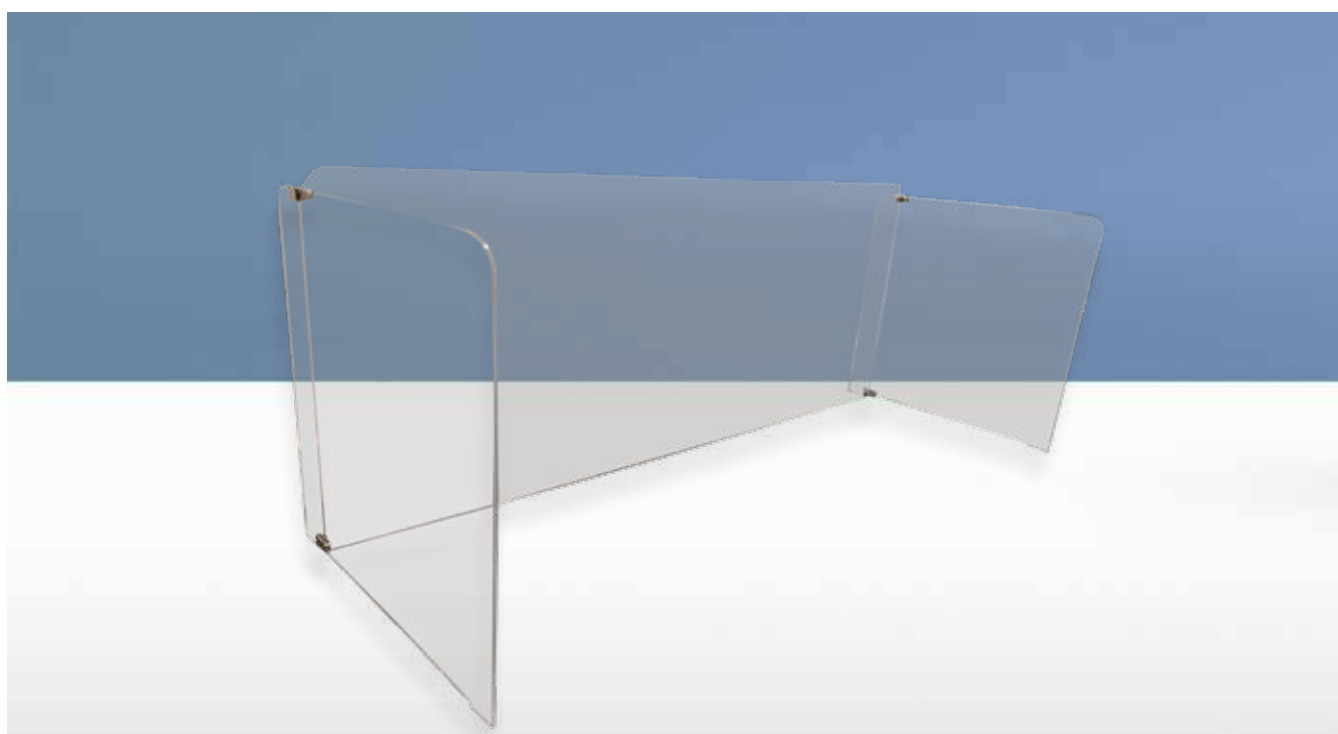

CLUSTER SCREENS SCREENS & PODS

Code	Description (finish size)	Price
800mm High With 600mm Deep Return		
FSRS06806	600W X 800H Rear Screen with 600D X 800H Return	£572
FSRS08806	800W X 800H Rear Screen with 600D X 800H Return	£606
FSRS10806	1000W X 800H Rear Screen with 600D X 800H Return	£638
FSRS12806	1200W X 800H Rear Screen with 600D X 800H Return	£673
FSRS14806	1400W X 800H Rear Screen with 600D X 800H Return	£706
FSRS16806	1600W X 800H Rear Screen with 600D X 800H Return	£738
800mm High With 800mm Deep Return		
FSRS06808	600W X 800H Rear Screen with 800D X 800H Return	£636
FSRS08808	800W X 800H Rear Screen with 800D X 800H Return	£669
FSRS10808	1000W X 800H Rear Screen with 800D X 800H Return	£702
FSRS12808	1200WX 800H Rear Screen with 800D X 800H Return	£736
FSRS14808	1400W X 800H Rear Screen with 800D X 800H Return	£769
FSRS16808	1600W X 800H Rear Screen with 800D X 800H Return	£802
800mm High With 1000mm Deep Return		
FSRS06810	600W X 800H Rear Screen with 1000D X 800H Return	£699
FSRS08810	800WX 800H Rear Screen with 1000D X 800H Return	£733
FSRS10810	1000W X 800H Rear Screen with 1000D X 800H Return	£765
FSRS12810	1200W X 800H Rear Screen with 1000D X 800H Return	£799
FSRS14810	1400WX 800H Rear Screen with 1000D X 800H Return	£834
FSRS16810	1600W X 800H Rear Screen with 1000D X 800H Return	£866

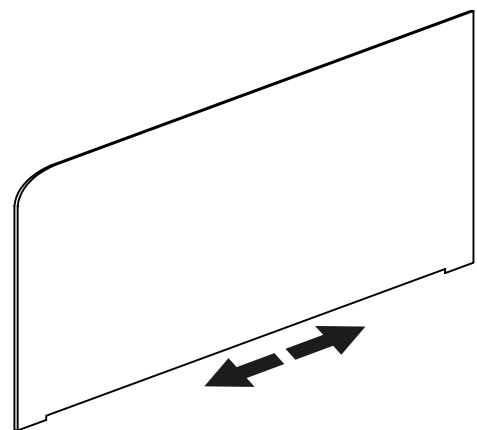
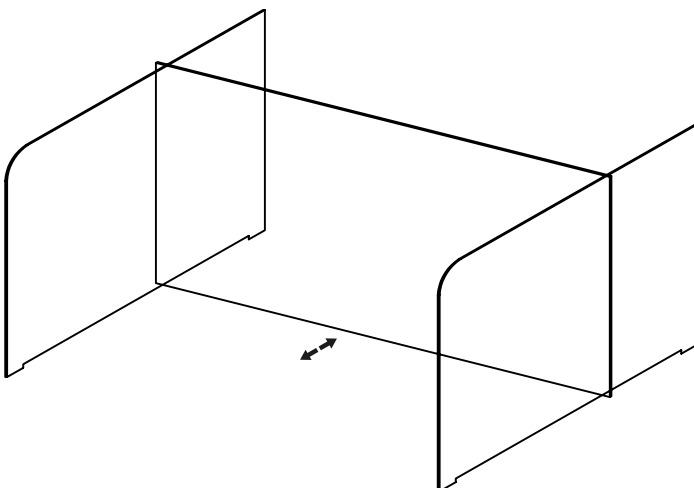

Bracket is adjustable along the void

CURVED VISION PANELS - MIRAGE LITE

SCREENS & PODS

Specification

- 5mm thick
- Clear acrylic, easily cleanable
- Supplied with 2 x fixing brackets
- Can be added to Mirage Lite curved desk mounted screens
- Edges are diamond polished with all sharp corners removed

Acrylic Options -



Solid White is a surcharge +25%

Code	Description (finish size)	Price
300mm High		
SML0603	Fully Glazed Screen Shaped to Suit Mirage Lite 570W X 300H	£338
SML0803	Fully Glazed Screen Shaped to Suit Mirage Lite 770W X 300H	£342
SML1003	Fully Glazed Screen Shaped to Suit Mirage Lite 970W X 300H	£376
SML1203	Fully Glazed Screen Shaped to Suit Mirage Lite 1170W X 300H	£408
SML1403	Fully Glazed Screen Shaped to Suit Mirage Lite 1370W X 300H	£440
SML1603	Fully Glazed Screen Shaped to Suit Mirage Lite 1570W X 300H	£475
SML1803	Fully Glazed Screen Shaped to Suit Mirage Lite 1770W X 300H	£561
400mm High		
SML0604	Fully Glazed Screen Shaped to Suit Mirage Lite 570W X 400H	£380
SML0804	Fully Glazed Screen Shaped to Suit Mirage Lite 770W X 400H	£382
SML1004	Fully Glazed Screen Shaped to Suit Mirage Lite 970W X 400H	£424
SML1204	Fully Glazed Screen Shaped to Suit Mirage Lite 1170W X 400H	£472
SML1404	Fully Glazed Screen Shaped to Suit Mirage Lite 1370W X 400H	£509
SML1604	Fully Glazed Screen Shaped to Suit Mirage Lite 1570W X 400H	£548
SML1804	Fully Glazed Screen Shaped to Suit Mirage Lite 1770W X 400H	£647
500mm High		
SML0605	Fully Glazed Screen Shaped to Suit Mirage Lite 570W X 500H	£417
SML0805	Fully Glazed Screen Shaped to Suit Mirage Lite 770W X 500H	£424
SML1005	Fully Glazed Screen Shaped to Suit Mirage Lite 970W X 500H	£475
SML1205	Fully Glazed Screen Shaped to Suit Mirage Lite 1170W X 500H	£522
SML1405	Fully Glazed Screen Shaped to Suit Mirage Lite 1370W X 500H	£577
SML1605	Fully Glazed Screen Shaped to Suit Mirage Lite 1570W X 500H	£629
SML1805	Fully Glazed Screen Shaped to Suit Mirage Lite 1770W X 500H	£736



MOBILE FLOOR STANDING SCREENS SCREENS & PODS

Specification

- 3mm thick
- Clear acrylic, easily cleanable
- Mobile frame
- On lockable castors

Acrylic Options -



Solid White is a surcharge +25%

Code	Description (finish size)	Price
1400mm High		
MSA1408	Mobile Glazed Screen 800W X 1400H	£414
MSA1410	Mobile Glazed Screen 1000W X 1400H	£494
MSA1412	Mobile Glazed Screen 1200W X 1400H	£662
1600mm High		
MSA1608	Mobile Glazed Screen 800W X 1600H	£433
MSA1610	Mobile Glazed Screen 1000W X 1600H	£535
MSA1612	Mobile Glazed Screen 1200W X 1600H	£694
1800mm High		
MSA1808	Mobile Glazed Screen 800W X 1800H	£463
MSA1810	Mobile Glazed Screen 1000W X 1800H	£565
MSA1812	Mobile Glazed Screen 1200W X 1800H	£758
Linking Brackets		
FLA90	90 Degree Bracket (supplied in pairs)	£32
FLAST	Straight Link Bracket (supplied in pairs)	£32



Screens & Pods

STATIC FLOOR STANDING SCREENS SCREENS & PODS

Specification

- 3mm thick
- Clear acrylic, easily cleanable
- Static frame

Acrylic Options -

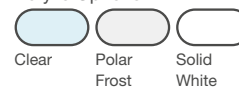

Solid White is a surcharge +25%

Code	Description (finish size)	Price
1400mm High		
FSA1408	Static Glazed Screen 800W X 1400H	£394
FSA1410	Static Glazed Screen 1000W X 1400H	£475
FSA1412	Static Glazed Screen 1200W X 1400H	£642
1600mm High		
FSA1608	Static Glazed Screen 800W X 1600H	£414
FSA1610	Static Glazed Screen 1000W X 1600H	£516
FSA1612	Static Glazed Screen 1200W X 1600H	£675
1800mm High		
FSA1808	Static Glazed Screen 800W X 1800H	£444
FSA1810	Static Glazed Screen 1000W X 1800H	£546
FSA1812	Static Glazed Screen 1200W X 1800H	£738
Linking Brackets		
FLA90	90 Degree Bracket (supplied in pairs)	£32
FLAST	Straight Link Bracket (supplied in pairs)	£32



MFC & ACRYLIC SCREENS SCREENS & PODS

Specification

- 3mm thick acrylic
- Floor standing
- Lower section in MFC
- Upper section in acrylic
- Static frame
- Choice of MFC finishes

Acrylic Options -

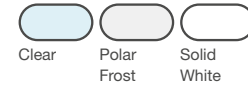

Solid White is a surcharge +25%

Code	Description (finish size)	Price
1600mm High		
FSW0816	800W x 1600H Floor Standing Screen with MFC (lower)	£485
FSW1016	1000W x 1600H Floor Standing Screen with MFC (lower)	£492
FSW1216	1200W x 1600H Floor Standing Screen with MFC (lower)	£529
FSW1416	1400W x 1600H Floor Standing Screen with MFC (lower)	£606
FSW1616	1600W x 1600H Floor Standing Screen with MFC (lower)	£612
1800mm High		
FSW0818	800W x 1800H Floor Standing Screen with MFC (lower)	£518
FSW1018	1000W x 1800H Floor Standing Screen with MFC (lower)	£531
FSW1218	1200W x 1800H Floor Standing Screen with MFC (lower)	£566
FSW1418	1400W x 1800H Floor Standing Screen with MFC (lower)	£646
FSW1618	1600W x 1800H Floor Standing Screen with MFC (lower)	£656
2000mm High		
FSW0820	800W x 2000H Floor Standing Screen with MFC (lower)	£531
FSW1020	1000W x 2000H Floor Standing Screen with MFC (lower)	£545
FSW1220	1200W x 2000H Floor Standing Screen with MFC (lower)	£582
FSW1420	1400W x 2000H Floor Standing Screen with MFC (lower)	£666
FSW1620	1600W x 2000H Floor Standing Screen with MFC (lower)	£676



INTRODUCTION

STORAGE





For metal finishes please see
Technical Information section.

Pastel Paint
Surcharge = £32 per item.



For board finishes please see
Technical Information section.

Adlington Oak
Surcharge = £64 per item
Light Concrete
Surcharge = £64 per item

We offer a comprehensive range of storage units, including a variety of pedestals, hinged door, tambour fronted, open fronted and filing units.



denotes grain
direction

- Three handle options are available, please see below for details.
- All locking units have a suited key system with optional master keys. 2 Keys are supplied with every lockable unit - one with collapsible / folding fob.

HOW TO SPECIFY YOUR HANDLE

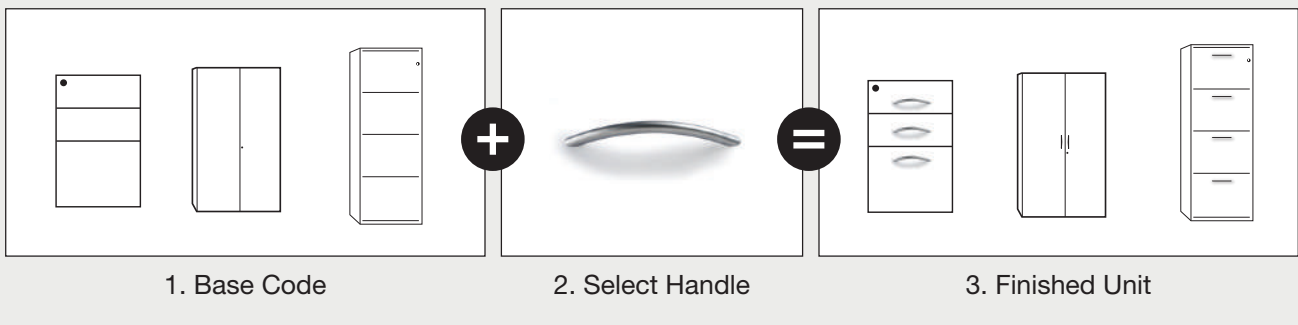

Handle type B				
	BLACK	GREY	WHITE	SILVER
Handle type C				
	BLACK	GREY	WHITE	SILVER
Handle type D				
	BLACK	GREY	WHITE	SILVER

PEDESTALS STORAGE



Pedestals are designed to suit all desking ranges and are available as mobile or static.

- Available with two, three and four drawers - including shallow & filing drawers.
- Desk high pedestals are available in 600mm and 800mm depths.

Base code	Description	W	D	H	MFC Price
-----------	-------------	---	---	---	-----------

Under Desk

Mobile	Static	Description	W	D	H	MFC Price		
2DM	2DS	2 drawer	430	x 600	x 555	£333	↑↓	
3DM	3DS	3 drawer	430	x 600	x 555	£333		

Tall Under Desk

Mobile	Static	Description	W	D	H	MFC Price		
3PUM	3PUS	3 drawer	430	x 600	x 625	£415	↑↓	

Please note, Tall Under Desk pedestals do not work with Bench² single sided desks with increased depth trays

Tall Under Desk Slimline

Mobile	Static	Description	W	D	H	MFC Price		
3SPUM	3SPUS	3 drawer	340	x 600	x 625	£415	↑↓	

Please note, Tall Under Desk pedestals do not work with Bench² single sided desks with increased depth trays

600mm Deep Desk High

Mobile	Static	Description	W	D	H	MFC Price		
2D6M	2D6S	2 drawer	430	x 600	x 727	£469	↑↓	
3D6M	3D6S	3 drawer	430	x 600	x 727	£446		
4D6M	4D6S	4 drawer	430	x 600	x 727	£469		

600mm Deep Desk High - Slimline

Mobile	Static	Description	W	D	H	MFC Price		
2SD6M	2SD6S	2 drawer	340	x 600	x 727	£469	↑↓	
3SD6M	3SD6S	3 drawer	340	x 600	x 727	£446		
4SD6M	4SD6S	4 drawer	340	x 600	x 727	£469		

600mm Deep Desk High - Extended top

Mobile	Static	Description	W	D	H	MFC Price		
3D68M	3D68S	3 drawer	430	x 800	x 727	£483	↔	

800mm Deep Desk High

Mobile	Static	Description	W	D	H	MFC Price		
2D8M	2D8S	2 drawer	430	x 800	x 727	£593	↔	
3D8M	3D8S	3 drawer	430	x 800	x 727	£567		
4D8M	4D8S	4 drawer	430	x 800	x 727	£593		

Storage

10 Year
Guarantee

PEDESTALS STORAGE

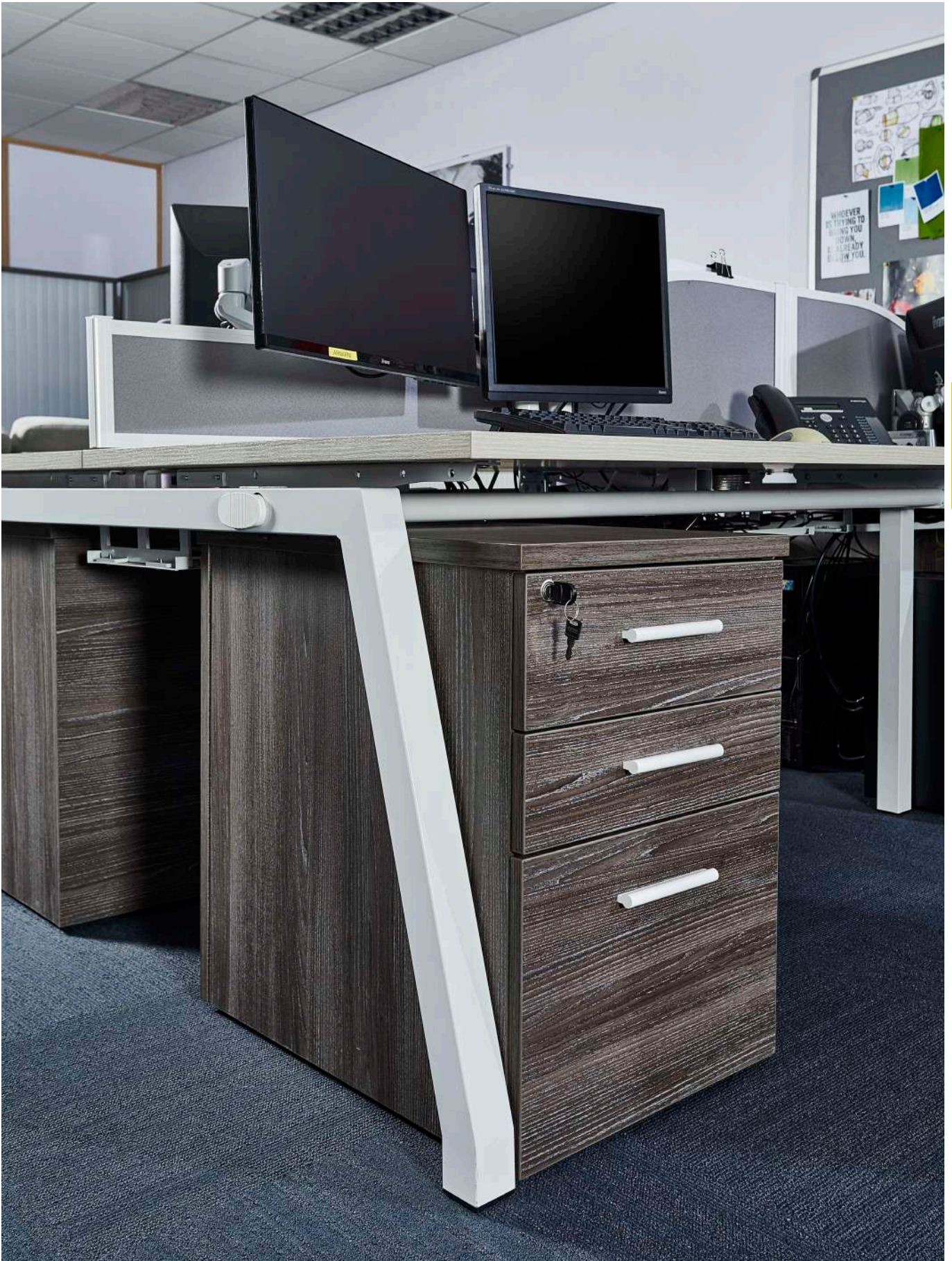

Storage

Tall Under Desk Pedestal with Type D Handles

PEDESTALS & STORAGE UNITS

STORAGE

10 Year Guarantee

- Fly over top pedestals extend worksurfaces and can convert desks into workstations.
- File hutches utilise above desk space for file storage.



Base code Description W D H MFC Price

Fly Over Top - For use with Rectangular Desk

3DFSL	Left hand	1000	x	600	x	727	£560
3DFSR	Right hand	1000	x	600	x	727	£560

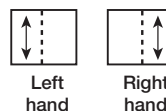

Left hand shown



Fly Over Top - For use with Wave Desk

3DFWL	Left hand	1000	x	600	x	727	£560
3DFWR	Right hand	1000	x	600	x	727	£560

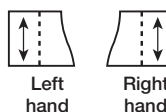

Left hand shown



Fly Over Top - For use with Angular Desk

3DFAL	Left hand	1000	x	600	x	727	£560
3DFAR	Right hand	1000	x	600	x	727	£560

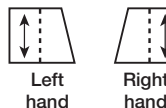

Left hand shown



Rear Fitting 3 Drawer Pedestal & File Hutch

3D8RH	800 deep	430	x	800	x	1107	£734
3D6RH	600 deep	430	x	600	x	1107	£591

File hutch accepts A4 & Foolscap lever arch files & box files.

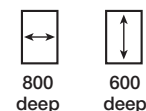

Side Fitting 3 Drawer Pedestal & File Hutch

3D8SH	800 deep	430	x	800	x	1107	£755
3D6SH	600 deep	430	x	600	x	1107	£626

File hutch accepts A4 & Foolscap lever arch files & box files.

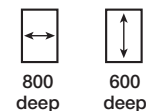

800mm Deep Desk High Combination - Lockable Hinged Door

CP84L	Left hand	430	x	800	x	727	£568
CP84R	Right hand	430	x	800	x	727	£568
CP83L	Left hand	340	x	800	x	727	£568
CP83R	Right hand	340	x	800	x	727	£568

Supplied with adjustable shelf.

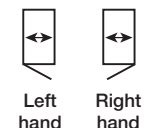

600mm Deep Desk High Combination - Single Lockable Hinged Door

CP64L	Left hand	430	x	600	x	727	£485
CP64R	Right hand	430	x	600	x	727	£485
CP63L	Left hand	340	x	600	x	727	£485
CP63R	Right hand	340	x	600	x	727	£485

Supplied with adjustable shelf.

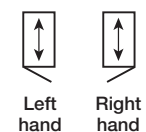

Storage



Tall Under Desk Pedestal

Base code	Description	W	D	H	MFC Price
-----------	-------------	---	---	---	-----------

800mm Deep Desk High Combination - Open Fronted

BCOP84Z	Open front	430	x	800	x	727	£488
BCOP83Z	Open front	340	x	800	x	727	£488

Supplied with adjustable shelf.



600mm Deep Desk High Combination - Open Fronted

BCOP64Z	Open front	430	x	600	x	727	£410
BCOP63Z	Open front	340	x	600	x	727	£410
BPU64Z	Open front	430	x	600	x	625	£410
BPU63Z	Open front	340	x	600	x	625	£410

Supplied with adjustable shelf.



Pen Trays

Code	Description	Price
SLPT	Black only - slide out pen tray. Fits to underside of desk top.	£54
P/TRAY	Black only - suitable for all pedestals except slim-line	£22
S/TRAY	Black only - suitable for slim-line	£29

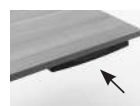

SLPT



SLPT

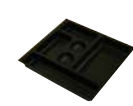

S/TRAY



P/TRAY

System storage is available in hinged door, vertical tambour, side opening and open fronted variations.

Each accept a comprehensive range of fitments to suit your storage needs.

- Tambour units have integral handles as part of the doors.
- Vertical tambour have additional finger-pull section to aid opening.
- Accessories to be ordered separately.



Base code	Description	W		D		H	MFC Price
Cupboard with Hinged Doors							
HD86	Standard	950	x	520	x	2207	£1,079
HD79	Standard	950	x	520	x	2007	£928
HD72	Standard	950	x	520	x	1837	£770
HD56	Standard	950	x	520	x	1607	£620
HD48	Standard	950	x	520	x	1227	£564
HD40	Standard	950	x	520	x	1007	£534
HD29	Standard	950	x	520	x	727	£503
HD296	600mm ext top	950	x	600	x	727	£553
HD298	800mm ext top	950	x	800	x	727	£567

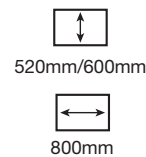

Wardrobe Conversion - Supplied with 4 Shelves and 1 Coat Rail

Can not be used with vertical tambour cupboards

WC86	2207 High cupboard	862	x	426	x	2112	£411
WC79	2007 High cupboard	862	x	426	x	1912	£384
WC72	1837 High cupboard	862	x	426	x	1744	£351
WC56	1607 High cupboard	862	x	426	x	1514	£323



Cupboard with Open Front

OF86Z	Standard	950	x	520	x	2207	£620
OF79Z	Standard	950	x	520	x	2007	£564
OF72Z	Standard	950	x	520	x	1837	£500
OF56Z	Standard	950	x	520	x	1607	£435
OF48Z	Standard	950	x	520	x	1227	£376
OF40Z	Standard	950	x	520	x	1007	£346
OF29Z	Standard	950	x	520	x	727	£311
OF29EZ	600mm ext top	950	x	600	x	727	£363
OF29EEZ	800mm ext top	950	x	800	x	727	£384

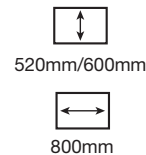

Cupboard with Side Opening Tambour Door -

Please specify tambour colour - Black, Grey, Silver or White
Does not require handles.

SUST79Z	Standard	1100	x	520	x	2007	£1,184
SUST72Z	Standard	1100	x	520	x	1837	£992
SUST56Z	Standard	1100	x	520	x	1607	£831
SUST48Z	Standard	1100	x	520	x	1227	£770
SUST40Z	Standard	1100	x	520	x	1007	£742
SUST29Z	Standard	1100	x	520	x	727	£710
SUST29EZ	600mm ext top	1100	x	600	x	727	£768
SUST29EEZ	800mm ext top	1100	x	800	x	727	£782

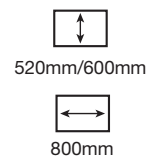

Cupboard with Vertical Opening Tambour Door -

Please specify tambour colour - Black, Grey, Silver or White
Does not require handles.

TS86Z	Standard	950	x	520	x	2207	£1,282
TS79Z	Standard	950	x	520	x	2007	£1,091
TS72Z	Standard	950	x	520	x	1837	£938
TS56Z	Standard	950	x	520	x	1607	£790
TS48Z	Standard	950	x	520	x	1227	£731
TS40Z	Standard	950	x	520	x	1007	£703



Accessories (Black metalwork only)



CSLF
Combi shelf
790mm of A4 or foolscap filing also accepts 275 or 330 lateral files

£74



ROSF
Roll out suspension frame
780mm of A4 or foolscap filing

£139



ROD
Roll out drawer
809mm x 387mm x 105mm

£162



ROSD
Roll out slotted drawer with 5 dividers
809mm x 387mm x 105mm

£213



ASM
Adjustable slotted metal shelf with 5 dividers
868mm x 410mm x 155mm

£144



ALFR
Adjustable lateral filing rail
790mm of lateral filing accepts 275 or 330 lateral files

£62



MROS
Metal roll out shelf
870mm x 410mm x 20mm

£98



AWSZ
Adjustable shelf, 25mm thick MFC
868mm x 418mm x 25mm

£46



AMS
Adjustable shelf - Metal
870mm x 410mm x 20mm

£64



WHSZ
Wooden hat shelf & coat rail, 25mm thick MFC
868mm x 418mm x 25mm

£144



Side Opening Tambour Door

SYSTEM CAPACITY PLANNING

STORAGE

Please note: the below capacities are to be used as a guide and are for reference only.

--- Denotes vertical tambour limit.

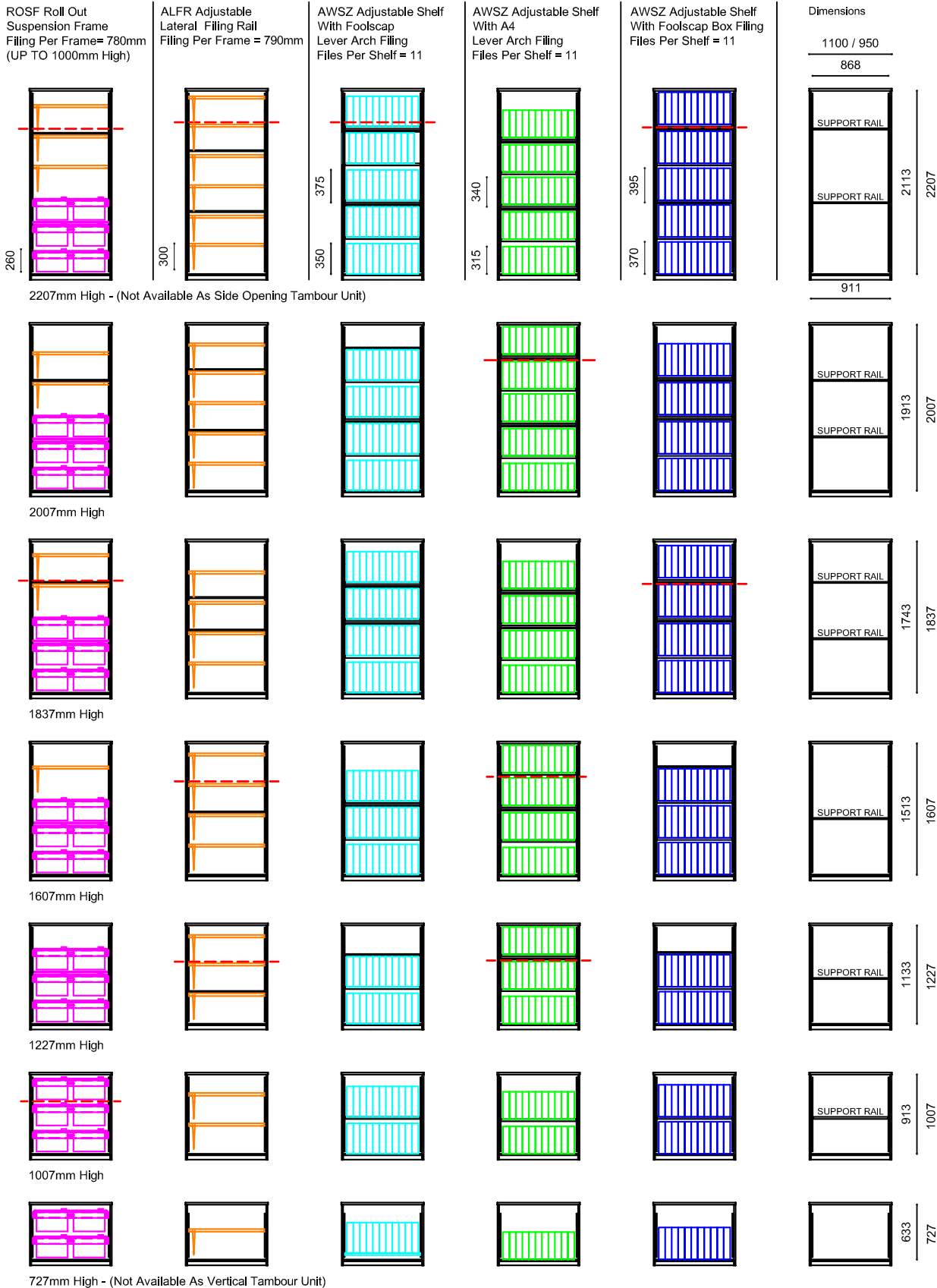

Storage

BOF unit shelf positions (shown with optional HD1 doors)

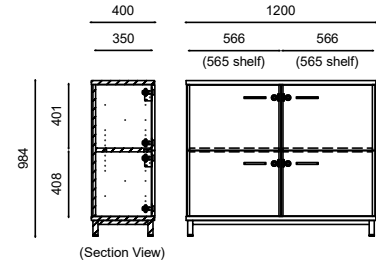
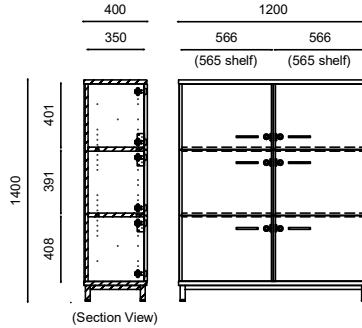
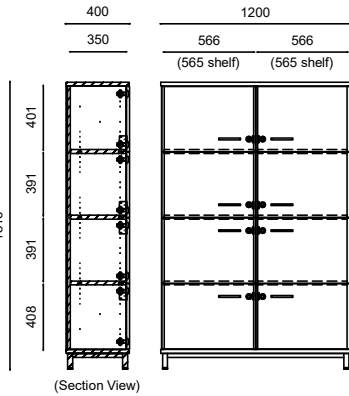

BOF unit shelf positions (shown with optional HD1 doors)

Optional BAWSZ positions when used with optional post door sets (HDPL/HDPR)

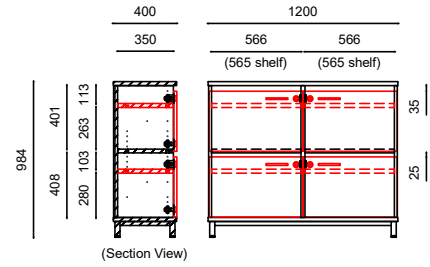
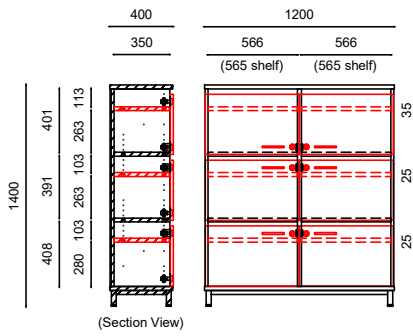
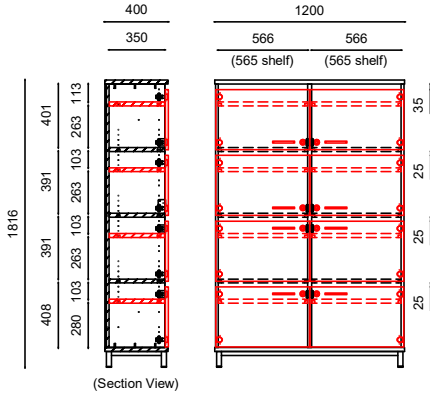

Credenza Unit Specification

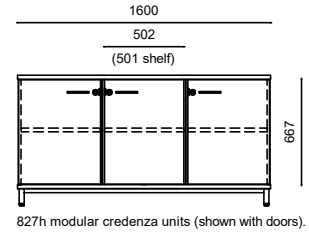
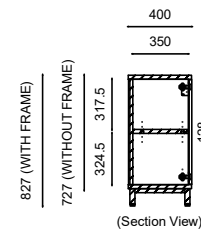
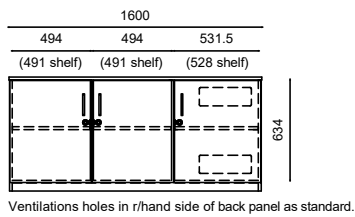
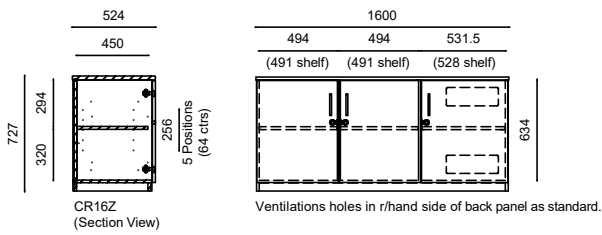

Pigeon Hole Top Unit Specification

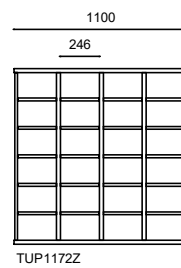
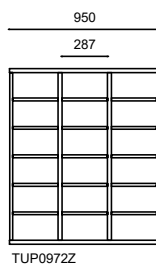
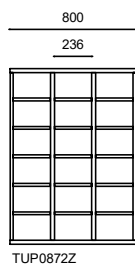
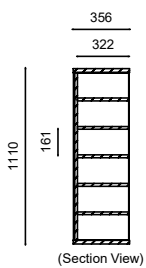
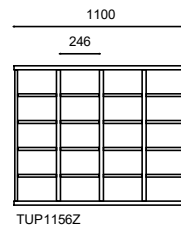
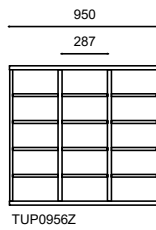
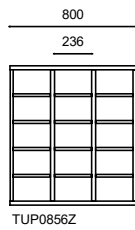
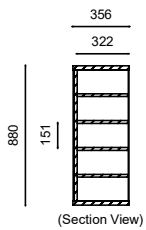

CABINETS & UNITS STORAGE

10 Year
Guarantee

Filing storage is based around foolscap sizes and allows users to use filing pockets to hold documents.

- Filing drawers include anti-tilt mechanisms as standard.



Code	Description	W	D	H	MFC Price
Filing Cabinets					
515mm of foolscap filing per drawer.					
FC4	4 Drawer	480	x 600	x 1352	£723
FC3	3 Drawer	480	x 600	x 1037	£588
FC2	2 Drawer	480	x 600	x 727	£500
FC28	2 Drawer ext top	480	x 800	x 727	£534



600mm



800mm



950mm Wide 3 Drawer Side Filing Units

770mm of foolscap filing per drawer.

SFU93	Standard	950	x 520	x 1017	£1,059
-------	----------	-----	-------	--------	--------



520mm/600mm



800mm



950mm Wide 2 Drawer Side Filing Units

770mm of foolscap filing per drawer.

SFU9	Standard	950	x 520	x 727	£750
SFU96	600mm ext top	950	x 600	x 727	£809
SFU98	800mm ext top	950	x 800	x 727	£823

800mm Wide 3 Drawer Side Filing Units

690mm of foolscap filing per drawer.

SFU83	Standard	800	x 520	x 1017	£1,031
-------	----------	-----	-------	--------	--------



520mm/600mm



800mm

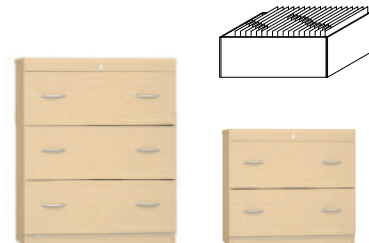

800mm Wide 2 Drawer Side Filing Units

690mm of foolscap filing per drawer.

SFU8	Standard	800	x 520	x 727	£731
SFU86	600mm ext top	800	x 600	x 727	£786
SFU88	800mm ext top	800	x 800	x 727	£796

Desk High Lockable Double Door Storage Units

800mm wide units supplied with adjustable wooden shelf.
1200mm wide units supplied with central divider with one adjustable wooden shelf each side.

SU12DZ	Standard	1200	x 520	x 727	£790
SU126DZ	600mm ext top	1200	x 600	x 727	£836
SU128DZ	800mm ext top	1200	x 800	x 727	£863
HD31	Standard	800	x 520	x 727	£520
HD316	600mm ext top	800	x 600	x 727	£568
HD318	800mm ext top	800	x 800	x 727	£580



520mm/600mm



800mm



Open fronted unit

800mm wide units supplied with adjustable wooden shelf.
1200mm wide units supplied with central divider with one adjustable wooden shelf each side.

SU12Z	Standard	1200	x 520	x 727	£517
SU126Z	600mm ext top	1200	x 600	x 727	£577
SU128Z	800mm ext top	1200	x 800	x 727	£591
SU31Z	Standard	800	x 520	x 727	£340
SU31EZ	600mm ext top	800	x 600	x 727	£387
SU31EEZ	800mm ext top	800	x 800	x 727	£396



520mm/600mm



800mm



800mm wide unit

10 Year
Guarantee

CABINETS & UNITS STORAGE



Storage

Desk High Lockable Double Door Storage, Cupboard with Hinged Doors and Vertical Tambour Unit

TOP & BASE UNITS STORAGE



By adding top units to base units, simple combination storage can be created. Top shelving units can also be fitted to System Storage, so increasing the possibilities.

- Top units available with open fronts or sliding glass doors.
- Base units match the height of desking and can be used as desk end storage.

Code Description W D H MFC Price

950mm Wide Top Units

Supplied with adjustable wooden shelf. Accepts 2 rows of foolscap box files.

TUO29Z	Open fronted	950	x	350	x	887	£326
TUG29Z	Glass doors	950	x	350	x	887	£473

800mm Wide Top Units

Supplied with adjustable wooden shelf. Accepts 2 rows of foolscap box files.

QTUO08Z	Open fronted	800	x	350	x	887	£316
QTUG08Z	Glass doors	800	x	350	x	887	£465

Sliding Door Lock

TUGLK							£55
-------	--	--	--	--	--	--	-----

2 Tier Wave Side Opening Tambour Units

Please specify tambour colour - Black, Grey, Silver or White
Supplied with adjustable wooden shelf. Accepts 2 rows of A4 files.

SUSTWRZ	Right hand	1000	x	600/800	x	727	£982
SUSTWLZ	Left hand	1000	x	600/800	x	727	£982

2 Tier Rectangular Side Opening Tambour Unit

Please specify tambour colour - Black, Grey, Silver or White
Supplied with adjustable wooden shelf. Accepts 2 rows of A4 files.

SUSTSZ		800	x	600	x	727	£763
--------	--	-----	---	-----	---	-----	------

2 Tier Radial Side Opening Tambour Units

Please specify tambour colour - Black, Grey, Silver or White

SURSTRZ	Right hand	800	x	600	x	727	£982
SURSTLZ	Left hand	800	x	600	x	727	£982

2 Tier Wave Open Fronted Unit

Supplied with adjustable wooden shelf. Accepts 2 rows of A4 files.

SUSOWRZ	Right hand	1000	x	600/800	x	727	£638
SUSOWLZ	Left hand	1000	x	600/800	x	727	£638

2 Tier Rectangular Open Fronted Unit

Supplied with adjustable wooden shelf. Accepts 2 rows of A4 files.

SUSOSZ		800	x	600	x	727	£498
--------	--	-----	---	-----	---	-----	------



Left hand shown



Left hand shown



10 Year
Guarantee

TOP & BASE UNITS STORAGE



Storage

2 Drawer Side File Unit with Open Fronted Top Unit

BOOKCASES & PIGEON HOLE UNITS STORAGE

10 Year Guarantee

Though each unit has adjustable shelves, each tier is normally based on fooscap box file dimensions. Pigeon Hole units are designed to sit on 'Base' storage units.

- Pigeon Hole units match System Storage heights when fitted to base units.
- 'SU' units are desk height and can be used to extend worksurfaces.



Code	Description	W		D		H	MFC Price
------	-------------	---	--	---	--	---	-----------

Radial Bookcases

Accepts 2 rows of A4 files.

SURZ	2 tier	800	x	800	x	727	£415
SUR6Z	2 tier	600	x	600	x	727	£388



SUR86RZ	2 tier	800	x	600	x	727	£415
SUR86LZ	2 tier	800	x	600	x	727	£415

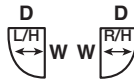

Desk High Bookcase

Accepts 2 rows of A4 files.

SUB16Z*	2 Tier	1600	x	320	x	727	£552
SUB12Z*	2 Tier	1200	x	320	x	727	£465
SUB10Z	2 Tier	1000	x	320	x	727	£385
SUB08Z	2 Tier	800	x	320	x	727	£302
SUB06Z	2 Tier	600	x	320	x	727	£278

800, 1000 & 1600mm wide

600 & 1200mm wide



* with central divider

Please note, Desk High Bookcases have fixed shelves

Open Fronted Bookcase Shelving

Accepts rows of A4 / fooscap lever arch & box files. 760mm per shelf. *B5Z requires wall fixing for stability. Shelves adjustable on 64mm centres - 5 positions.

B5Z*	5 Tier	800	x	320	x	2120	£615
B4Z	4 Tier	800	x	320	x	1710	£526
B3Z	3 Tier	800	x	320	x	1300	£435
B2Z	2 Tier	800	x	320	x	890	£326



Bookcase Shelving with Locking Doors

Accepts rows of A4 / fooscap lever arch & box files. 760mm per shelf. *requires wall fixing for stability. Shelves adjustable on 64mm centres - 5 positions.

B5DZ*	5 Tier	800	x	350	x	2120	£1,070
B4DZ*	4 Tier	800	x	350	x	1710	£798
B3DZ*	3 Tier	800	x	350	x	1300	£629
B2DZ*	2 Tier	800	x	350	x	890	£530



BWFB	Wall fixing bracket						£26
------	---------------------	--	--	--	--	--	-----

Pigeon Hole Top Units

1607 high when placed on 727 base unit. Shelves supplied loose.

TUP1156Z	20	1100	x	350	x	880	£849
TUP0956Z	15	950	x	350	x	880	£697
TUP0856Z	15	800	x	350	x	880	£670



1837 High placed on 727 Base Unit. Shelves supplied loose.

TUP1172Z	24	1100	x	350	x	1110	£898
TUP0972Z	18	950	x	350	x	1110	£732
TUP0872Z	18	800	x	350	x	1110	£703

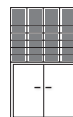

Indicative image shown

10 Year
Guarantee

BOOKCASES & PIGEON HOLE UNITS STORAGE



Storage

Open Fronted Bookcase Shelving

MODULAR STORAGE



Modular Storage is simple shelving units that can be specified as either open fronted or with a combination of lockable doors to suit the users' needs.



- Wooden doors have a suited key system with optional master keys.

Code	Compartments	W	D	H	MFC Price
Open Fronted Storage Units					
Compartment dimensions 390h x 566w x 350d					
BOF18Z	8	1200	x 400	x 1816	£661
BOF14Z	6	1200	x 400	x 1400	£456
BOF10Z	4	1200	x 400	x 984	£353



Hinged Locking Wooden Doors - Sold separately

HD4	4 Tier door set	1186	x 18	x 1660	£278
HD3	3 Tier door set	1186	x 18	x 1244	£187
HD2	2 Tier door set	1186	x 18	x 828	£120
HD1	1 Tier door set	1186	x 18	x 412	£96



Storage



8 Compartment Storage Units with Wooden 1 & 2 Tier Hinged Doors

10 Year Guarantee

Single Locking Post Wooden Door Set - Sold separately

Designed to allow envelopes & small packages to be pushed into cupboard.
Recommended that extra wooden shelf be used - See below

							Price
HDPL	Left hand	1186	x	18	x	380	£66
HDPR	Right hand	1186	x	18	x	380	£66



BAWSZ	Wooden shelf 25mm thick	560	x	320	x	25	£39
-------	----------------------------	-----	---	-----	---	----	-----



Hinged Non Locking Frosted Glass doors - Sold separately

GHD2	2 tier door set	1186	x	6	x	828	£423
GHD1	1 tier door set	1186	x	6	x	412	£306



Hinged Non Locking Clear Glass doors - Sold separately

GHD2C	2 tier door set	1186	x	6	x	828	£423
GHD1C	1 tier door set	1186	x	6	x	412	£306

Arrangements

A selection of storage:
Units configurations
showing alternative
door arrangements.



4 Compartment Storage Units and 6 Compartment Storage Unit with Wooden 1 Tier Hinged Doors

MODULAR CREDENZAS & MOBILE UNITS STORAGE



Modular Storage Credenzas are simple shelving units that can be specified as either open fronted or with a combination of doors to suit the users' needs.

- Credenza units are desk height when steel frames are removed.
- Wooden doors are lockable.



Credenza Style Storage:

Supplied with 3 shelves. When used without frames units are desk height.

Code	Description	W	D	H	MFC Price		
CW316	3 Wooden Door Unit Lockable	1600	x 400	x 827	£710		
CG316	3 Frosted Glass Door Unit	1600	x 400	x 827	£1,271		
CG316C	3 Clear Glass Door Unit	1600	x 400	x 827	£1,271		
BCR16Z	Open Fronted Unit	1600	x 400	x 827	£510		
CW216	2 Wooden Door Unit Lockable	1600	x 400	x 827	£642		
CG216	2 Frosted Glass Door Unit	1600	x 400	x 827	£1,005		
CG216C	2 Clear Glass Door Unit	1600	x 400	x 827	£1,005		
CR165	3 Wooden Door Unit Lockable Without frame	1600	x 520	x 727	£840		

Mobile Under Desk Unit

BMOF10	Open Unit	1000	x 400	x 625	£434		
BMOF08	Open Unit	800	x 400	x 625	£392		
BMOF06	Single Opening Unit	600	x 400	x 625	£365		

Mobile Under Desk Unit with Locking Doors

MHD10	Hinged Doors	1000	x 400	x 625	£567		
MHD08	Hinged Doors	800	x 400	x 625	£510		
MHD06L	Single Left Door Unit	600	x 400	x 625	£483		
MHD06R	Single Right Door Unit	600	x 400	x 625	£483		

Optional Upholstered Seat Cushion - Band 1

Fits to top of Under Desk Units to provide perching area

UPSC10		1000	x 400	x 50	£189	
UPSC08		800	x 400	x 50	£151	
UPSC06		600	x 400	x 50	£114	



Unit not included

10 Year
Guarantee



Storage

2 Wooden Door Credenza Unit

Kulture



Kulture Quoll Cupboards come in four optional sizes. You can assemble display units or top units on top of them and in doing so create a simple and adaptable combination storage, thereby making best use of your workspace.



KQ12PLST
Plinth
W1200 x D400 x H135
£308

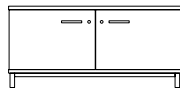

KQ1206ST
Low Storage Unit
W1200 x D400 x H615
£413

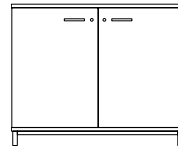

KQ1210ST
Tall Storage Unit
W1200 x D400 x H995
£473



KQ08PLST
Plinth
W800 x D400 x H135
£289

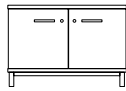

KQ0806ST
Low Storage Unit
W800 x D400 x H615
£391

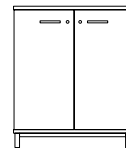

KQ0810ST
Tall Storage Unit
W800 x D400 x H995
£437





KULTURE QUOLL STORAGE

Style meets flexibility in the new Kulture range from Gresham. Designed to support the dynamic, ever-changing workplace, each item is modular and re-configurable to suit your changing needs. The versatility in the design is endless; as items can be built in any number of combinations. The range is ideal for the modern workspace as agile and activity-based working practices continue to evolve.



KQSHelf
Shelf
W370 x D361
£40



KQBOX
Box
W370 x D361 x H376
£204

Storage

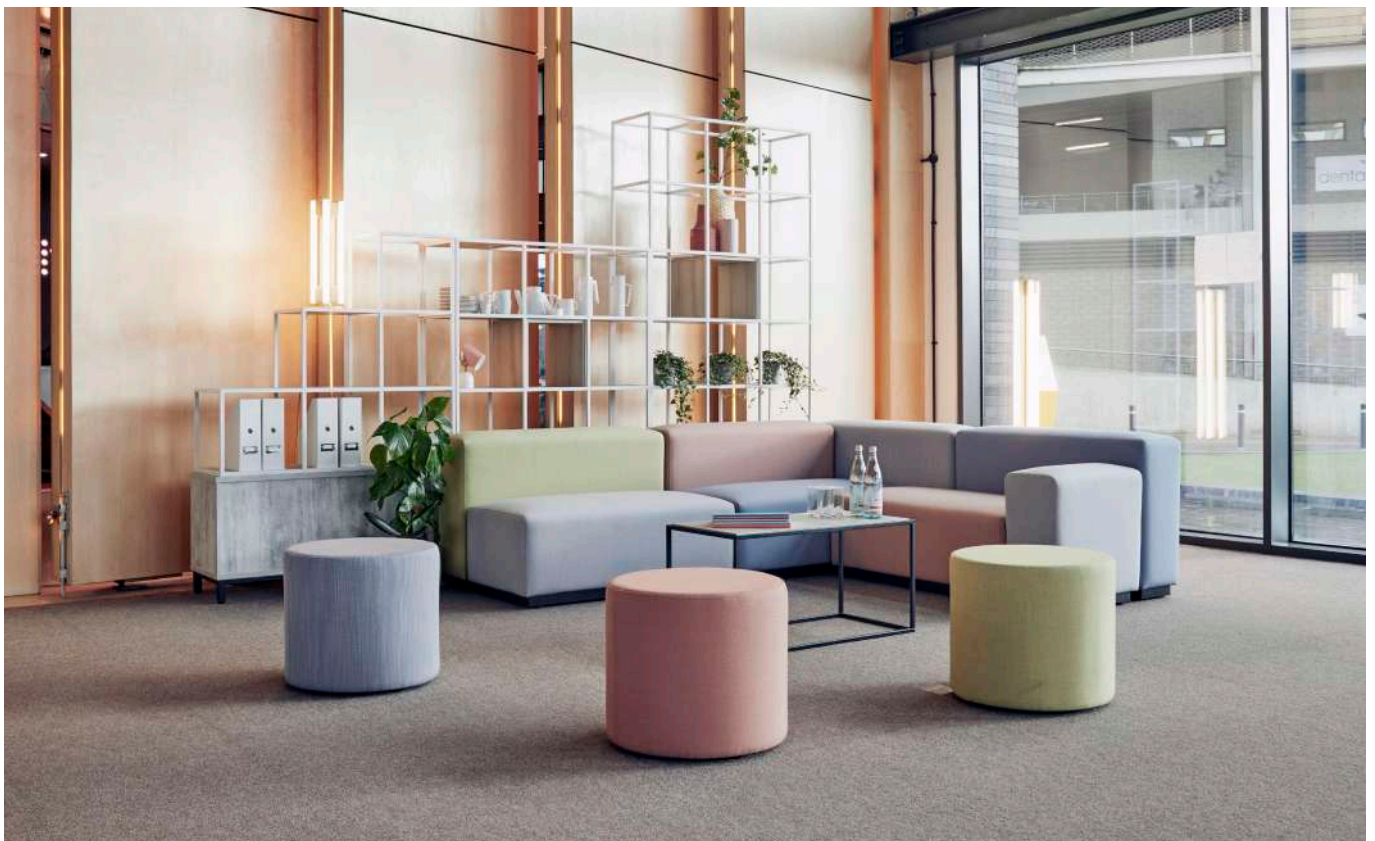

Kulture



Totally re-configurable, the cube-shaped units allow you to adapt the size and shape of your storage as your workspace changes.



KQ1W1H
1 Wide x 1 High Unit
W408 x D398 x H398
£424



KQ1W2H
1 Wide x 2 High Unit
W408 x D398 x H777
£629



KQ1W3H
1 Wide x 3 High Unit
W408 x D398 x H1157
£831



KQ1W4H
1 Wide x 4 High Unit
W408 x D398 x H1537
£1,031



KQ1W5H
1 Wide x 5 High Unit
W408 x D398 x H1916
£1,234



KQ2W1H
2 Wide x 1 High Unit
W797 x D398 x H398
£669

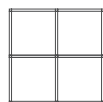

KQ2W2H
2 Wide x 2 High Unit
W797 x D398 x H777
£997



KQ2W3H
2 Wide x 3 High Unit
W797 x D398 x H1157
£1,327

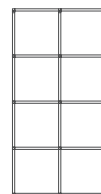

KQ2W4H
2 Wide x 4 High Unit
W797 x D398 x H1537
£1,653



KQ2W5H
2 Wide x 5 High Unit
W797 x D398 x H1916
£1,982

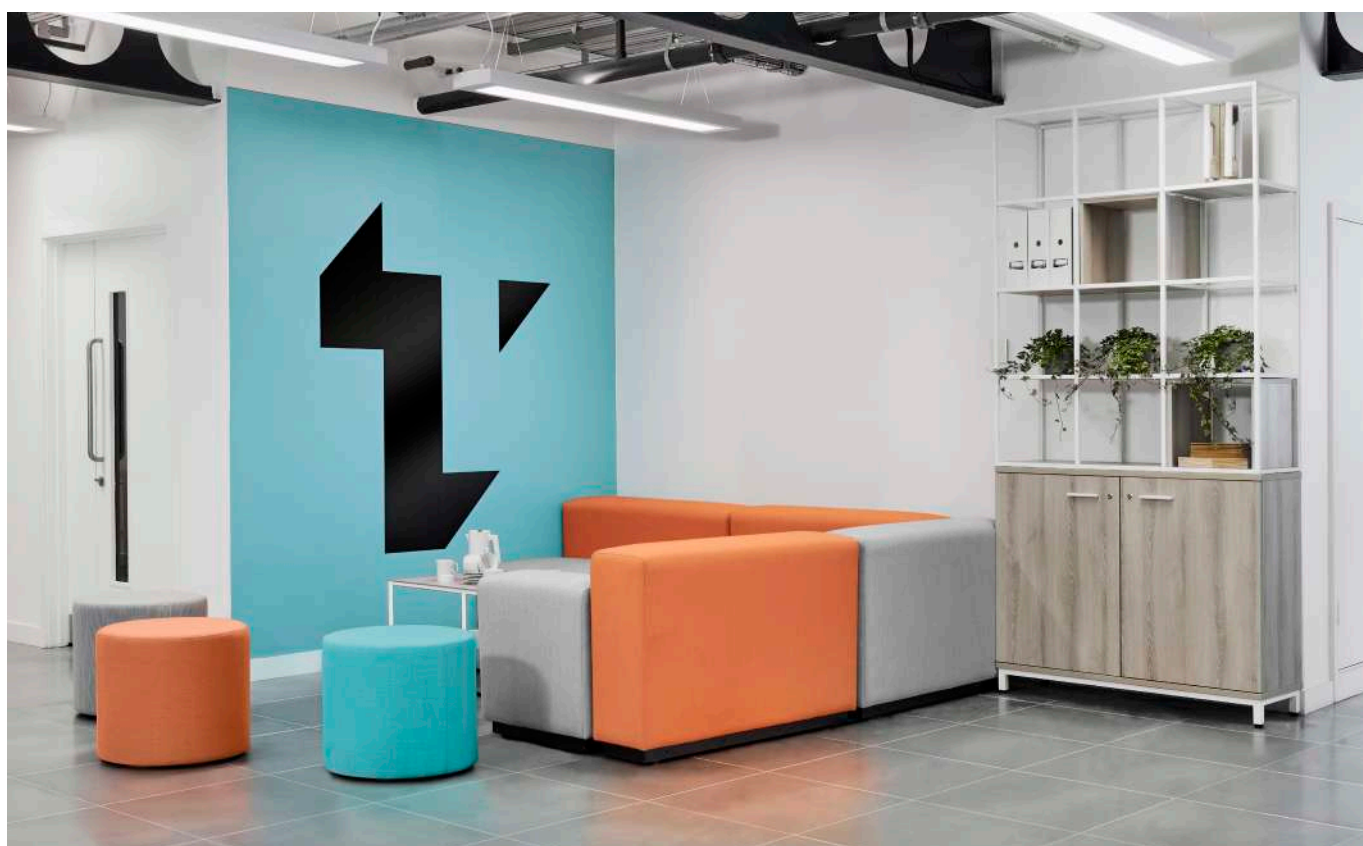



Kulture



Totally re-configurable, the cube-shaped units allow you to adapt the size and shape of your storage as your workspace changes.



KQ3W1H
3 Wide x 1 High Unit
W1187 x D398 x H398
£915



KQ3W2H
3 Wide x 2 High Unit
W1187 x D398 x H777
£1,367

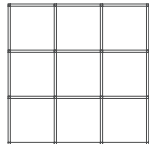

KQ3W3H
3 Wide x 3 High Unit
W1187 x D398 x H1157
£1,821

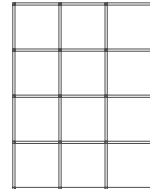

KQ3W4H
3 Wide x 4 High Unit
W1187 x D398 x H1537
£2,276

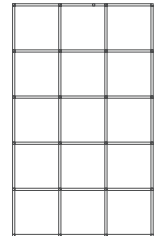

KQ3W5H
3 Wide x 5 High Unit
W1187 x D398 x H1916
£2,730

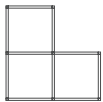

KQ2W2HST
2 Wide x 2 High Step Unit
W797 x D398 x H777
£880

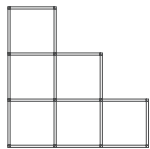

KQ3W3HST
3 Wide x 3 High Step Unit
W1187 x D398 x H1157
£1,457

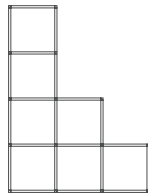

KQ3W4HST
3 Wide x 4 High Step Unit
W1187 x D398 x H1537
£1,660

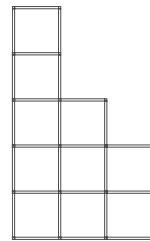

KQ3W5HST
3 Wide x 5 High Step Unit
W1187 x D398 x H1916
£2,114

Storage



PLANTERS STORAGE

NEW
ADDITION

10 Year
Guarantee

In keeping with the biophilic trend, bring the outdoors in. Create a calming aesthetic and add colour to your interiors.

- Non-irrigated plant holder
- For use with standard storage units



Code	Dimensions			MFC Price
	W	D	H	
PLANT1	800	x 320	x 200	£156
PLANT2	1600	x 400	x 200	£182



Storage



Planter on a 2 Wooden Door Credenza Unit

10 Year
Guarantee

STEEL/MFC UNITS & LOCKERS STORAGE



Storage



Steel and MFC Lockers

INTRODUCTION

BESPOKE

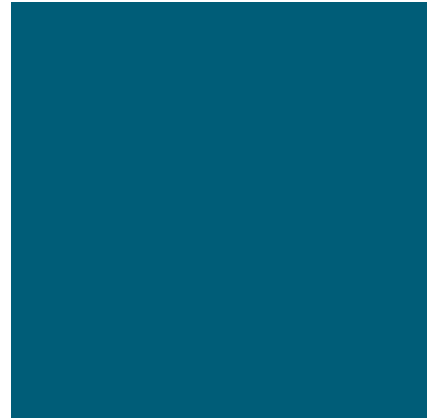

Bespoke

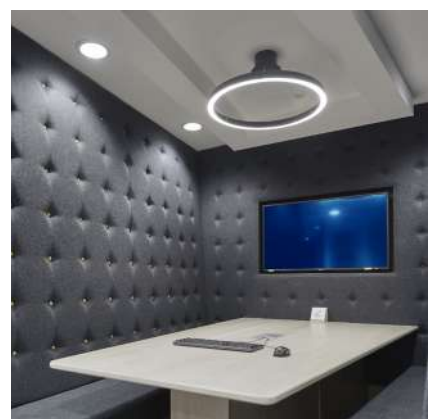



GRESHAM
BESPOKE

FROM CONCEPT TO COMPLETION

Gresham Bespoke design everything from scratch, starting with the earliest concept sketches through to the installation of our completed products.

From detailed technical drawings we can manufacture and construct every component of a project on site, including meticulous testing and trialling to meet a briefs' specifications. This ensures that we only ever deliver the highest standard of quality bespoke products, that always stand the tests of time.



Bespoke



OUR PROCESS

BESPOKE

'The Devil is in the detail' and when supplying tailored solutions, it's all about getting every aspect right to meet your needs, in the timescales that suit you and at the right price.

Client Requirement



1

Though we offer a huge selection of products within our standard portfolio, there's always a time when something different is required. This is where we listen to you and find out what you or your team need. This is where the wish list can be fine-tuned.

Concepts

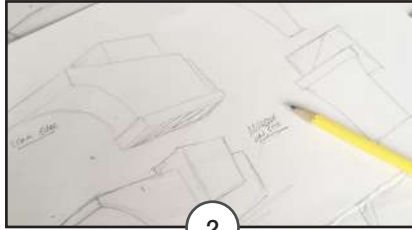

2

Whether starting from 'set-in-stone' specifications or a clean piece of paper, we discuss your requirements with you, offer advice and can quickly determine whether the solutions need to go down our 'Specials' or 'Bespoke' route; offering alternatives where possible. These can be simply illustrated to help communicate the ideas and formulate the plan of action.

Design and CGI



3

Once agreed, we develop the ideas into detailed designs that will meet all exacting standards. We understand, however, that some things are difficult to imagine, so as part of our service we can produce computer generated images of the suggested products shown in detail or placed within your workspace. Colours, textures, shapes and scale can all be shown, bringing the whole concept to life.

Site Template



4

We appreciate that real life can differ from concept, so when needed, members of our specialist team will visit site to confirm measurements or produce templates for manufacturing parts to ensure an exact fit during the installation phase. It's all about getting it right!

Manufacture



5

Being able to draw upon our design experience, state-of-the-art manufacturing facility and combining this with our hand-crafted joinery expertise enables us to work with an enormous array of materials and processes. This allows us to turn those concepts into reality.

Installation



6

Whether it's a simple drop-off on site or a complete fitted solution, it's all part of our complete service in supporting you. It doesn't stop there either. If needed, once the furniture is installed we can offer user guides and explanations to ensure each user benefits from the experience.



CASE STUDY BESPOKE



Bespoke

FINISHES & ADDITIONS

BESPOKE

We work closely with Architects, Designers & End users to help choose and specify finishes taking into consideration: Design, Manufacturing process, Durability & Budget.

Gresham Standard MFC



Standard range of finishes available in 18mm, 25mm & 36mm thick board. ABS edging is available either 1mm or 2mm thick in a matching finish or Multiplex. Refer to the Gresham Product Guide for available MFC finishes. Samples can be requested by contacting your account manager or our sales department.

Gresham Standard High Pressure Laminate

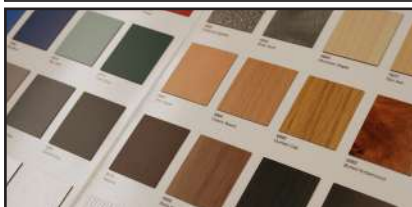

Matching laminate finishes that complement our standard MFC range. The core material is MDF, available with ABS edging at 1mm or 2mm thick with a matching finish or Multiplex. Refer to the Gresham Product Guide for available laminate finishes. Samples can be requested by contacting your account manager or our sales department.

Non Standard High Pressure Laminate



We offer hundreds of finishes from a range of manufacturers including plain colours, wood grain effect, textured finish, matt, high gloss, patterned and metallic finishes. Due to the wide range available, we do not hold samples in stock but they can be requested direct from the manufacturer. Alternatively email bespoke@gof.co.uk to request samples on your behalf.

Real Wood Veneer



We can select veneers with unique grain patterns to suit individual products highlighting the natural beauty of a wood finish. European Oak, Maple, Ash & American Black Walnut are all available. Samples can be requested by contacting your account manager or our sales department.

Solid Surface



Solid surface is an extremely versatile material that can be shaped and formed with seamless joints using thermoforming. The option for engraving is also available when choosing a solid surface finish. As an approved Corian fabricator we can offer a 10 year guarantee on our products.

Signage



Units can simply be customized to suit your building and work requirements to feed all the services through the furniture, directly to any reception equipment.

Glass



We can finish our units with toughened glass. Available as back painted or with coloured film backing, straight or curved.

Glass Counter



Available as straight or curved units, adding a clear protective layer.

Glass Front



Connected to Rectangular Base, Block or Hutch adding a touch of finesse.

Lighting



This subtle addition can highlight kick-plates, counters or recesses. This is supplied in a selection of styles to suit the application.

Cable Management Tunking and Outlets

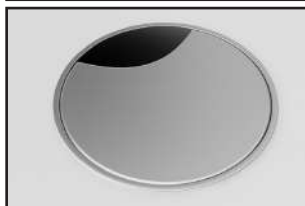

This addition can personalise the units, whether fitted to base units or hutches, glass or acrylic panel.

Feature Inlays



Adding more finesse to standard units, these strips are used to decoratively 'break-up' vertical surfaces and can be colour coordinated to suit with kick-plates.

Gate and Flap



Used to enclose users whilst providing access when units are adjacent to walls.

CASE STUDY BESPOKE



CASE STUDY

BESPOKE

Bespoke



CASE STUDY

BESPOKE



Bespoke



CASE STUDY

BESPOKE



Bespoke



CASE STUDY

BESPOKE



Bespoke



CASE STUDY

BESPOKE



Bespoke



CASE STUDY

BESPOKE



Bespoke



CASE STUDY
BESPOKE



Bespoke



Bespoke

CASE STUDY

BESPOKE



Bespoke

CASE STUDY BESPOKE

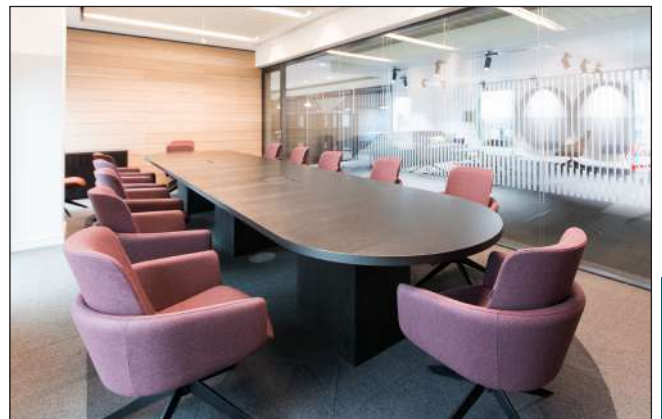

Bespoke

INTRODUCTION

TASK & VISITOR

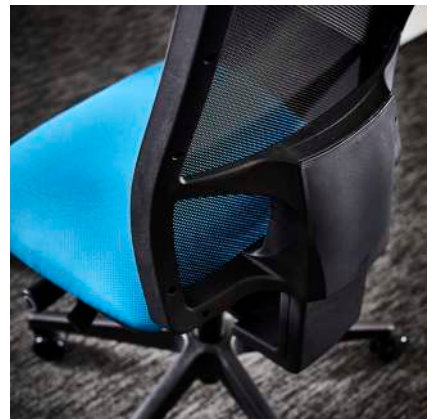
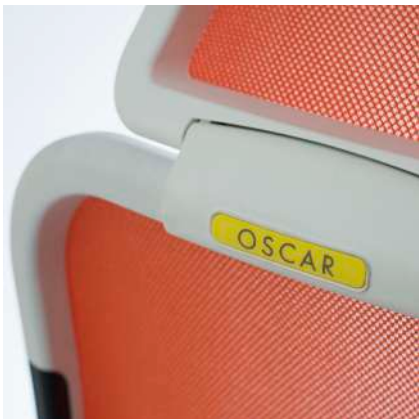



Selected items within this range are stackable. These items are identified within the product description.

For further information regarding stacking quantity - Please contact our Sales Department.



Items are available in a variety of fabrics. A number of products possess certain upholstery restrictions - these are therefore available in selected fabrics only and are identified within this brochure.

For further information regarding fabric suitability - Please contact our Sales Department.



Arms are available on designated product ranges as indicated within the relevant product thumbnails. Colour / Finish options are indicated on relevant product pages - where applicable.

For further information regarding Arm options - Please contact our Sales Department.



Feet are available on designated product ranges as indicated within the relevant product thumbnails. Colour / Finish options are indicated on relevant product pages - where applicable.

For further information regarding Feet options - Please contact our Sales Department.



Items include Reflex Foam Structure as standard.

Level 'S' tested to BS5459: Part 2: 2000.

Extreme Comfort.

Consistent Shape Retention.

Durability and long life.

Excellent Fire Retardant Properties.

We recommend that you request fabric samples prior to ordering.

Two tone upholstery is available on selected products. Please contact our Sales Department for further information.

You can find dimensions for all products in the technical data section of this brochure.

Please Note: All images shown are for illustrative purposes.

Some aspects of certain products may differ. Please contact our customer services department with any queries.

TASK SEATING MECHANISMS

TECHNICAL INFORMATION

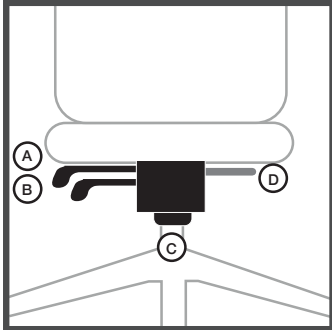

MECH 2

Points
Synchronized mechanism
Optional Seat Slide (50 mm movement)

Operation
A - Seat Height Adjustment
B - Seat & Back Angle Adjustment
(Synchronized)
C - Mechanism Tension Adjustment
D - Seat Depth Adjustment (Optional)

Used On
Platinum Plus Round
Platinum Plus Square
Platinum Ergo
Platinum Squared

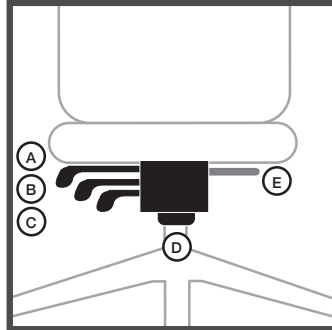

MECH 3

Points
Independent Seat & Back
Optional Seat Slide
Seat slider with 50 mm movement

Operation
A - Seat Height Adjustment
B - Seat Tilt
C - Back Angle Adjustment / Lock
D - Mechanism Tension Adjustment
E - Seat Depth Adjustment (Optional)

Used On
Platinum Plus Round
Platinum Plus Square
Platinum Ergo
Platinum Squared

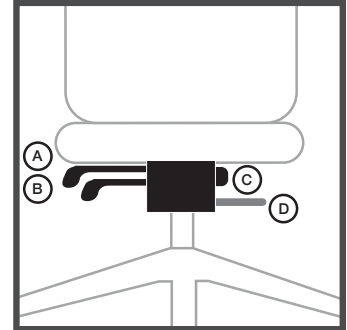

MECH 4

Points
Fixed Seat
Optional Seat Slide (50 mm movement)

Operation
A - Seat Height Adjustment
B - Back Angle Adjustment
C - Mechanism Tension Adjustment
D - Seat Depth Adjustment (Optional)

Used On
Adlington
Adlington Mesh

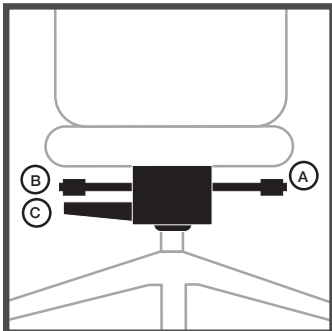

24/7 MECH

Points
Synchronized mechanism
Allows coordinated movement
(21° Back / 9° seat)
5 Lockable Back positions /
Safety antishock system
Seat Slide with 50 mm movement
& 5 locking positions

Operation
A - Lever: Lockable Seat Slide /
Button: Mechanism Limiter
B - Lever: Seat Height Adjustment /
Button: Lock
C - Mechanism Tension Adjustment

Used On
Bromley 24/7

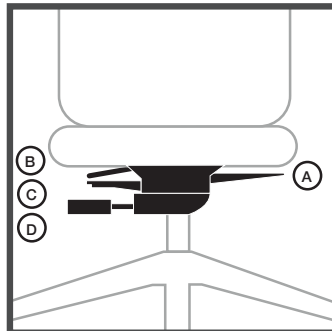

TO MECH

Points
Synchronized mechanism
Allows coordinated movement
(20.5° Back / 11° seat)
Lockable in selected position

Operation
A - Mechanism Release Handle / Position Lock
B - Seat Depth Adjustment
C - Seat Height Adjustment
D - Mechanism Tension Adjustment

Used On
Take Off Executive
Take Off

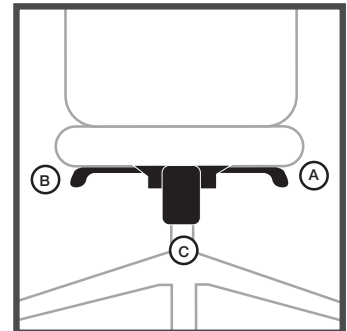

HQHE / HQME

Points
Knee Tilt
Back Tension Adjustment

Operation
A - Back / Knee Tilt / Back Angle Lock (Lift)
B - Seat Height Adjustment
C - Mechanism Tension Adjustment

Used On
Harlequin Executive

TASK SEATING MECHANISMS

TECHNICAL INFORMATION

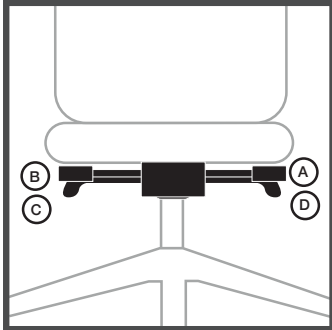

MECH 7

Points

Synchronized mechanism
Allows coordinated movement
5 Lockable Back positions
Seat Slide with 60 mm movement

Operation

A - Back Adjustment Lock
B - Back Angle Adjustment Tension
C - Seat Height Adjustment
D - Seat Depth Adjustment

Used On

G Series
G Series Mesh
Move Up
Platinum Plus Round
Platinum Plus Square
Santis Ergo
Santis Squared
Harlequin Mesh

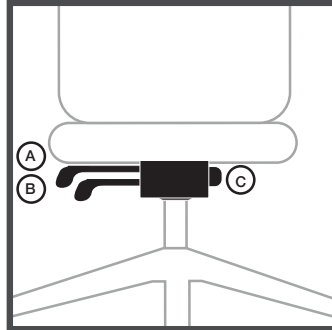

MECH 8

Points

Fixed Seat
Optional Seat Slide (50 mm movement)

Operation

A - Seat Height Adjustment
B - Back Angle Adjustment
C - Mechanism Tension Adjustment

Used On

Platinum Plus Round
Platinum Plus Square
Platinum Ergo
Platinum Squared

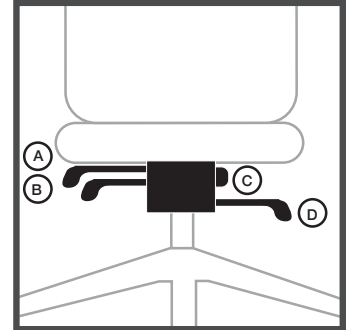

MECH 9

Points

Independent Seat & Back
Optional Seat Slide (50 mm movement)

Operation

A - Seat Height Adjustment
B - Back Angle Adjustment
C - Mechanism Tension Adjustment
D - Seat Angle Adjustment

Used On

Adlington
Adlington Mesh

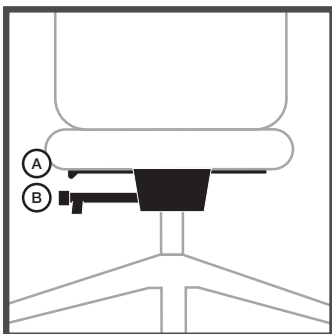

OSCAR MECH

Points

Self-weighting Synchro
Allows coordinated movement
5 Lockable Back positions
Seat Slide with 65 mm movement

Operation

A - Seat Slide Handle
B - Seat Height adjustment (Lift paddle)
Back Angle Adjustment (Twist end)

Used On

Oscar

TASK SEATING ARMS

TECHNICAL INFORMATION

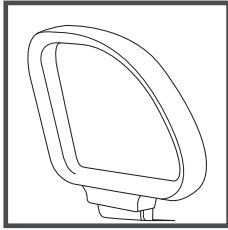

A2

Black Fixed Arms

Used On:
 Platinum Plus Round
 Platinum Plus Square
 Platinum Ergo
 Platinum Squared
 Adlington
 Adlington Mesh

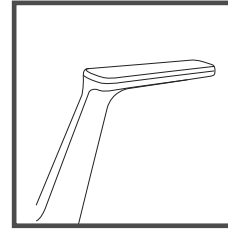

Alu to Arm

Fixed Polished
 Aluminium
 Arms/PU Pads

Used On:
 Take Off Executive

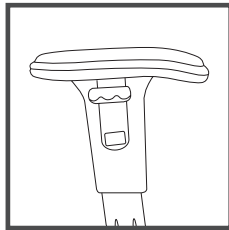

A8

Black Height
 Adjustable Arms (Lift
 Lever to Adjust Height)

Used On:
 Platinum Plus Round
 Platinum Plus Square
 Platinum Ergo
 Platinum Squared
 Platinum Mesh
 Santis Ergo
 Santis Squared
 Adlington
 Adlington Mesh
 Harlequin Mesh

Adjustment:

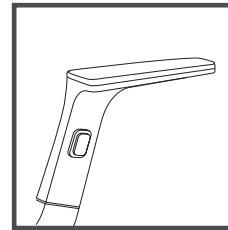

Blk H/A to Arm

Black Height
 Adjustable Arms/PU
 Pads (Lift Lever to
 Adjust Height)

Used On:
 Take Off Executive
 Take Off

Adjustment:

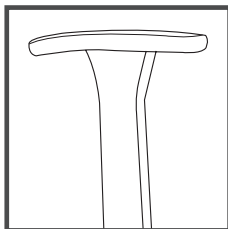

A1

Black Fixed Arms

Used On:
 Santis Ergo
 Santis Squared
 Platinum Mesh

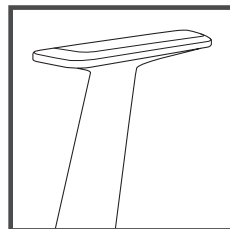

A23

Black Fixed Arms

Used On:
 G Series Fabric
 G Series Mesh
 Move Up

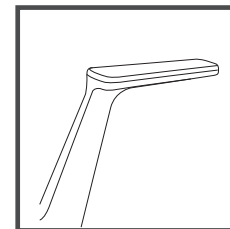

Blk to Arm

Black Fixed Arms/PU
 Pads

Used On:
 Take Off Executive
 Take Off

TASK SEATING ARMS

TECHNICAL INFORMATION

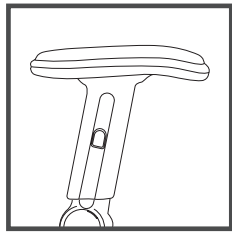

A13

Height Adjustable & Foldable Arms (Push Button to Adjust Height and Fold)

Used On:
 Platinum Plus Round
 Platinum Plus Square
 Platinum Ergo
 Platinum Squared
 Platinum Mesh
 Santis Ergo
 Santis Squared
 Adlington
 Harlequin Mesh

Adjustment:

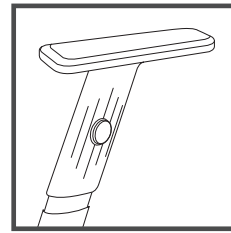

A24

Height Adjustable Arms (Lift Lever to Adjust Height)

Used On:
 G Series Fabric
 G Series Mesh
 Move Up

Adjustment:

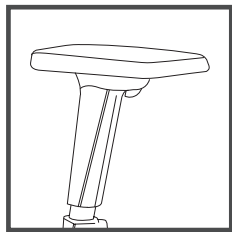

A4D

4D Multi-function Arms (Push Button to Adjust Height / Move Pad to Adjust Width Depth & Angle)

Used On:
 Platinum Plus Round
 Platinum Plus Squared
 Platinum Mesh
 Santis Ergo
 Santis Squared

Adjustment:

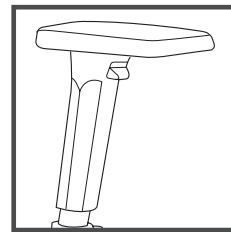

A25

4D Multi-function Arms (Push Button to Adjust Height / Move Pad to Adjust Width Depth & Angle)

Used On:
 G Series Fabric
 G Series Mesh
 Move Up

Adjustment:

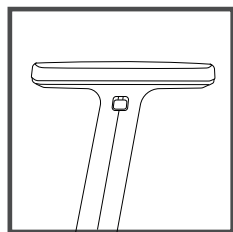

OSC

Black Height Adjustable Arms/PU Pads (Push Button to Adjust Height)

Used On:
 Oscar

Adjustment:

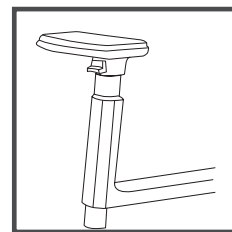

A22

Multi-function Push Button Arms (Push Button to Adjust Height / Release Lever to Adjust Width / Move Pad to Adjust Depth & Angle)

Used On:
 Bromley 24/7

Adjustment:

OSCAR

DESIGNED BY

JONES & PARTNERS

Oscar makes light work of long days at the office. Its sleek, modern styling cleverly hides innovative flexibility: interchangeable backrests that allow you to personalise your chair. Choose from a rainbow of colour options across frame, back panel, optional sprung headrest and seat. Lumbar support comes as standard and it's easy to adjust. Comfortable and dependable, every office needs an Oscar.

Product Features



Optional Extras

H	Sprung Headrest	£78
A	Standard Height Adjustable Arms	£114
D	Soft Castors	£28
E	Brake Unloaded Castors	£28
F	Soft Brake Unloaded Castors	£34
P	Polished Base	£76
M	Multi-functional 4D Arms	£146



How to specify:

	Base Colour	Hub Colour	Body Colour	Trim Colour	Mesh Colour		Optional Extras		
OS						-			
	B=Black	B=Black	B=Black	B=Black	B=Black 60999		A=Standard Height Adjustable Arms		
	G=Grey	G=Grey	G=Grey	G=Grey	G=Graphite 60025		C=Standard Castors		
	P=Polished (Surcharge)	W=White	W=White	O=Orange	L=Light Grey 60165		D=Soft Castors		
	W=White			W=White	O=Orange 63034		E=Brake Unloaded Castors		
				Y=Yellow	U=Blue 66063		F=Soft Brake Unloaded Castors		
					Y=Yellow 68137		H=Headrest		
							N=No Arms required		
							M=Multi-functional 4D Arms		

Example of code: OSBBWBY-AC (Oscar chair with black base, black hub, white body, black trim, yellow mesh with standard height adjustable arms and standard castors).

Visit our website to see the configurator.

Base Colours



Hub Colours



Body Colours Headrest, Cassette, Lumbar Arch



Trim Colours Plaque, Lumbar Pad



Mesh Colours



Yellow, Blue & Orange mesh colours are subject to availability. Please contact our Sales Department for further information.



OSCAR TASK & VISITOR

Headrest

Spring activated by the user.
*Available in Black / Grey / White Frame

Adjustable Lumbar Support

Lift or lower Lumbar Pad to suit
(100mm vertical adjustment)
*Available in Black / Grey / White /
Yellow / Orange

Arms

Standard Height Adjustable:
Press button situated on outer side of arm.
Lift or lower to suit
(Adjustable in height – 80mm)

Multi-functional 4D Arm:
Press button situated on outer side to raise or lower arms.
(Adjustable in height – 80mm)

Press button on inner side of arm pad to move it forward / backwards or side to side.
(Adjustable front to back – 50mm, each arm adjustable width - 30mm)

Mechanism

Self - Weighting Synchro

Height:
Lift paddle handle for height adjustment

Back Travel:
Twist end section for 5x back angle travel restriction settings

Seat Slide

Integrated 5 position Seat Slide located within seat outer plastic (Adjustable in depth - 65mm)

1. Lift and pull handle to operate
2. Whilst applying weight to the seat, move body forward or backwards to suit
3. Release handle to lock



Gabriel Runner 60165 (Mesh) Gabriel Elevation 2602 (Band 2) (Seat)

OSCAR TASK & VISITOR

5 Year
Guarantee

65mm Castor Options



Standard



Soft



Brake
Unloaded



Brake
Unloaded
Soft

Dimensions

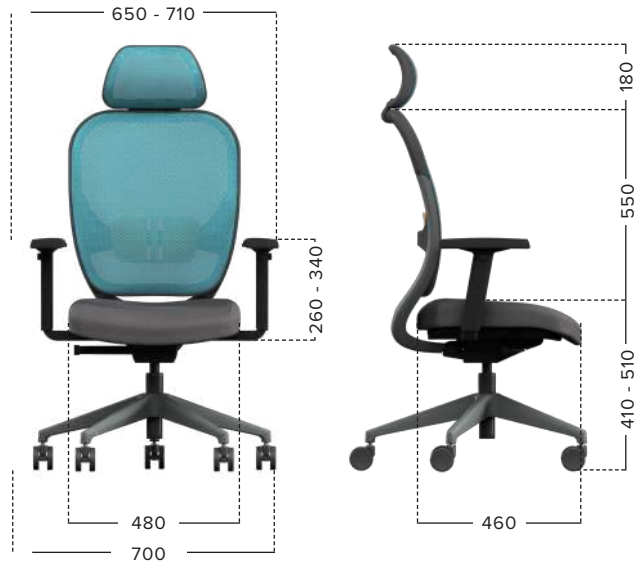

Gabriel Runner 60999 (Mesh) Gabriel Crisp 04201 (Band 4) (Seat)



OSCAR TASK & VISITOR

Oscar makes light work of long days at the office. Its sleek, modern styling cleverly hides innovative flexibility.

- Offers optimum back support with interchangeable backrest.
- Suited to intense working environments, which demand prolonged periods of sitting.
- Soft touch mesh.
- Adjustable lumbar pad.
- Synchronized side tension mechanism with seat slide and gas lift height adjustment.
- Multiple colour variations.



OSBBWB-Y-C

Band 1	£606
Band 2	£618
Band 3	£636
Band 4	£649
Band 5	£666
Band 6	£679
Band 7	£696



OSWWWB-C

Band 1	£606
Band 2	£618
Band 3	£636
Band 4	£649
Band 5	£666
Band 6	£679
Band 7	£696



OSBBWYU-C

Band 1	£606
Band 2	£618
Band 3	£636
Band 4	£649
Band 5	£666
Band 6	£679
Band 7	£696



OSGGBL-AC

Band 1	£720
Band 2	£733
Band 3	£751
Band 4	£763
Band 5	£781
Band 6	£795
Band 7	£809



OSWGBYB-AC

Band 1	£720
Band 2	£733
Band 3	£751
Band 4	£763
Band 5	£781
Band 6	£795
Band 7	£809



OSWWGGO-AC

Band 1	£720
Band 2	£733
Band 3	£751
Band 4	£763
Band 5	£781
Band 6	£795
Band 7	£809



OSWWGGU-ACH

Band 1	£797
Band 2	£813
Band 3	£828
Band 4	£841
Band 5	£858
Band 6	£872
Band 7	£890



OSWWGOL-ACH

Band 1	£797
Band 2	£813
Band 3	£828
Band 4	£841
Band 5	£858
Band 6	£872
Band 7	£890



OSBBWL-ACH

Band 1	£797
Band 2	£813
Band 3	£828
Band 4	£841
Band 5	£858
Band 6	£872
Band 7	£890



OSGBOU-ACH

Band 1	£797
Band 2	£813
Band 3	£828
Band 4	£841
Band 5	£858
Band 6	£872
Band 7	£890

Task & Visitor
Seating

KEEKO

TASK & VISITOR SEATING



A technical jewel and object of desire. Keeko is the ergonomically designed task chair that acts like a mirror to adapt to your body. Available in black or white with the option of mesh or fully upholstered backs for maximum comfort. The Keeko task chairs is available in a wide range of fabrics to suit your individual needs.

Product Features



- Available in black or white
- Soft touch pad
- Injected foam for the seat
- Self-weighting mechanism
- New Klea nylon base
- Reduced aluminium for extreme lightness
- Custom ergonomic armrest positions
- Anti-knee rise
- Independent levers that adjust to your posture



KEEBM
Black Plastic
with Mesh Back

Band 1	£810
Band 2	£824
Band 3	£844
Band 4	£862
Band 5	£884
Band 6	£902
Band 7	£921
Leather Group 1	POA



KEEWM
White Plastic
with Mesh Back

Band 1	£810
Band 2	£824
Band 3	£844
Band 4	£862
Band 5	£884
Band 6	£902
Band 7	£921
Leather Group 1	POA



KEEBF
Black Plastic
with Full Back

Band 1	£762
Band 2	£780
Band 3	£808
Band 4	£829
Band 5	£857
Band 6	£881
Band 7	£904
Leather Group 1	POA



KEEWF
White Plastic
with Full Back

Band 1	£762
Band 2	£780
Band 3	£808
Band 4	£829
Band 5	£857
Band 6	£881
Band 7	£904
Leather Group 1	POA



5 Year
Guarantee

HARLEQUIN EXECUTIVE TASK & VISITOR

Harlequin is a fully upholstered leather executive task chair, ideal for management office and traditional boardroom environments.

- Available in two back heights with gas lift height adjustability.
- Knee tilt and back tension adjustment mechanism.
- Chrome finish as standard.
- Accompanying visitor chair (Chrome Frame).

Additional Information

All prices shown below represent Black Leather.
Batch to batch variations in shade may occur within commercial tolerances.



HQHE-SB1
High Back with Fixed Arms
£1,181



HQME-SB1
Medium Back with Fixed Arms
£1,012



HQEC-SB1
Cantilever with Fixed Arms
£1,009



Shown in black leather - other colours available

TAKE OFF EXECUTIVE TASK & VISITOR

5 Year
Guarantee

Take Off Executive is the perfect executive task chair that delivers both dynamism and adaptability.

- Incorporates polished aluminium features.
- Synchronized mechanism with integrated seat slide and polished aluminium base come as standard.
- Ratchet back height adjustment.

Limited stock available. Please contact our Sales Department for further information.

Product Features



Additional Information

All prices shown below represent Leather Group 1 fabrics. Visitor Chair frame in Chrome.



TO1
High Back with Headrest
£1,104



TO2
High Back with Headrest
Black Fixed Arms/PU Pads
£1,170



TO3
High Back with Headrest
Fixed Polished Aluminium
Arms/PU Pads
£1,287



TO4
High Back with Headrest
Black Height Adjustable
Arms/PU Pads
£1,222



TO5
High Back
£1,037



TO6
High Back with Black Fixed
Arms/PU Pads
£1,104



TO7
High Back with Fixed Polished
Aluminium Arms/PU Pads
£1,222



TO8
High Back with Black Height
Adjustable Arms/PU Pads
£1,152



TO10
Medium Back
£1,006



TO11
Medium Back with
Black Fixed Arms/PU Pads
£1,074



TO12
Medium Back with Fixed
Polished Aluminium
Arms/PU Pads
£1,190



TO13
Medium Back with Black Height
Adjustable Arms/PU Pads
£1,124



TO14
Visitor Medium Back
£849

5 Year
Guarantee

TAKE OFF EXECUTIVE TASK & VISITOR

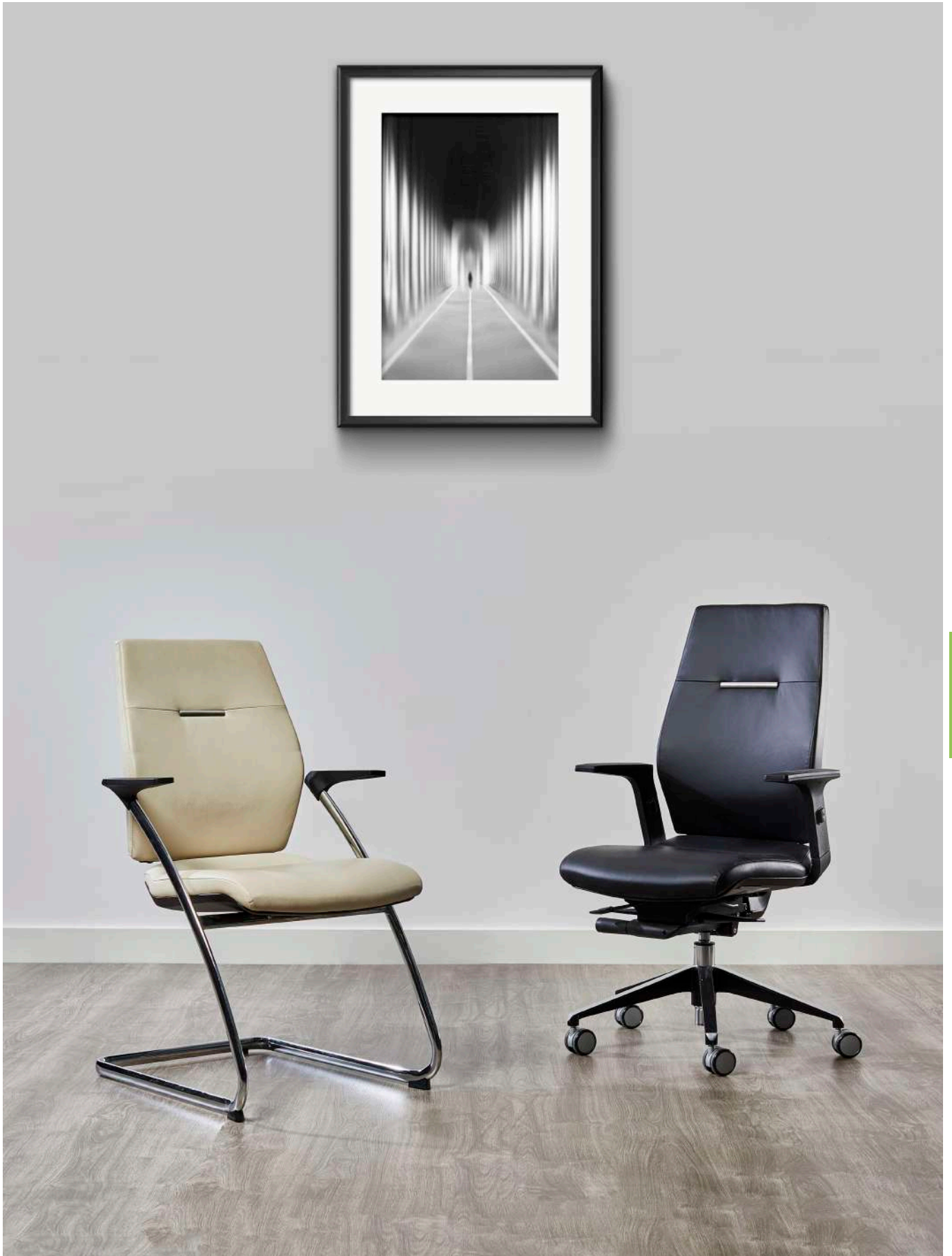

Task & Visitor
Seating

Shown in cream and black leather - other colours available

TAKE OFF TASK & VISITOR

5 Year
Guarantee

More than just style, Take Off is an innovative seating solution that can adapt to the user's body with easy to reach adjustments.

- High quality materials, mechanism and functionality provide increased comfort and productivity.
- Gas lift height adjustment
- Synchronized side tension mechanism complete with seat slide comes as standard.
- Ratchet back height adjustment.

Product Features



Additional Information

Visitor Chair frames in Silver only.

Optional Extras

X	Polished Aluminium Five Star Base	£60
---	-----------------------------------	-----





TAKE OFF TASK & VISITOR



TO20
High Back

Band 1	£750
Band 2	£762
Band 3	£791
Band 4	£815
Band 5	£838
Band 6	£862
Band 7	£887
Leather Group 1	£1,037



TO21
High Back with Black Fixed
Arms/PU Pads

Band 1	£817
Band 2	£829
Band 3	£857
Band 4	£882
Band 5	£905
Band 6	£930
Band 7	£953
Leather Group 1	£1,104



TO23
High Back with Black Height
Adjustable Arms/PU Pads

Band 1	£866
Band 2	£881
Band 3	£906
Band 4	£933
Band 5	£954
Band 6	£980
Band 7	£1,005
Leather Group 1	£1,152



TO24
Medium Back

Band 1	£682
Band 2	£696
Band 3	£723
Band 4	£750
Band 5	£770
Band 6	£796
Band 7	£822
Leather Group 1	£1,006



TO25
Medium Back with Black Fixed
Arms/PU Pads

Band 1	£750
Band 2	£762
Band 3	£791
Band 4	£815
Band 5	£838
Band 6	£862
Band 7	£887
Leather Group 1	£1,074



TO27
Medium Back with Black Height
Adjustable Arms/PU Pads

Band 1	£798
Band 2	£815
Band 3	£840
Band 4	£866
Band 5	£891
Band 6	£915
Band 7	£937
Leather Group 1	£1,124



TO28
Visitor Medium Back Cantilever
Armchair

Band 1	£598
Band 2	£611
Band 3	£639
Band 4	£664
Band 5	£690
Band 6	£713
Band 7	£735
Leather Group 1	£849

Task & Visitor
Seating

G SERIES FABRIC TASK & VISITOR



G Series Fabric is an outstanding task chair with a number of unique features.

- Combination of superb aesthetics and functionality.
- Provides comfort and support.
- Easy to use side-tension mechanism with seat slide comes as standard.
- Picture frame outer back with one-touch ratchet height adjustment.

Product Features



Additional Information

Visitor Chair frames in Silver - (Chrome Frame £82 surcharge).

Optional Extras

X	Polished Aluminium Five Star Base	£60
A23	Black Fixed Arms	£74
A24	Height Adjustable Arms	£106
A25	4D Multi Function Arms	£141



GSR/7
High Back with Headrest

Band 1	£735
Band 2	£750
Band 3	£765
Band 4	£784
Band 5	£798
Band 6	£819
Band 7	£834
Leather Group 1	£1,014



GS/7
High Back

Band 1	£658
Band 2	£667
Band 3	£688
Band 4	£700
Band 5	£720
Band 6	£735
Band 7	£753
Leather Group 1	£934



GSC
Visitor Medium Back Cantilever

Band 1	£630
Band 2	£647
Band 3	£687
Band 4	£718
Band 5	£748
Band 6	£779
Band 7	£809
Leather Group 1	£992



GSCA
Visitor Medium Back
Cantilever Armchair

Band 1	£637
Band 2	£658
Band 3	£692
Band 4	£723
Band 5	£754
Band 6	£789
Band 7	£819
Leather Group 1	£998

Task & Visitor
Seating



Vescom Lani 7060.49 (Band 6)

The G Series Mesh provides not only an enhanced ergonomic sit but unique aesthetic appeal.

- Easy to use side-tension mechanism with seat slide.
- One-touch ratchet height adjustment.
- Extra versatility and breathability (Black Mesh).
- Matching visitor chairs on either a four leg or cantilever base.
- Perfect for executive offices and meeting areas.

Product Features



Additional Information

Visitor Chair frames in Silver - (Chrome Frame £66 surcharge).

Optional Extras

X	Polished Aluminium Five Star Base	£60
A23	Black Fixed Arms	£74
A24	Height Adjustable Arms	£106
A25	4D Multi Function Arms	£141



GSMR/7
High Back with Headrest

Band 1	£735
Band 2	£750
Band 3	£765
Band 4	£784
Band 5	£798
Band 6	£819
Band 7	£834
Leather Group 1	£924



GSM/7
High Back

Band 1	£658
Band 2	£667
Band 3	£688
Band 4	£700
Band 5	£720
Band 6	£735
Band 7	£753
Leather Group 1	£841



GSMC
Visitor Medium Back Cantilever

Band 1	£630
Band 2	£647
Band 3	£687
Band 4	£718
Band 5	£748
Band 6	£779
Band 7	£809
Leather Group 1	£900



GSMCA
Visitor Medium Back Cantilever
Armchair

Band 1	£637
Band 2	£658
Band 3	£692
Band 4	£723
Band 5	£754
Band 6	£789
Band 7	£819
Leather Group 1	£910



Vescom Lani 7060.34 (Band 6)

MOVE UP TASK & VISITOR

5 Year
Guarantee

This intuitive chair has the simplest of adjustments.

- Unique synchronized mechanism with seat depth adjustment as standard.
- One touch back height adjustment allows the user to achieve the optimal seated position.
- Choice of a fabric or mesh back is complemented by a selection of fixed or adjustable arms.

Product Features



Additional Information

A25 Arm (height and width adjustable / sliding and rotating arm pad).
Visitor Chair frames in Silver / Black / Grey / White
(Chrome Frame £29 surcharge).

Optional Extras

X	Polished Aluminium Five Star Base	£60
---	-----------------------------------	-----





MOVE UP TASK & VISITOR



MU/7
Fully Upholstered

Band 1	£504
Band 2	£516
Band 3	£533
Band 4	£550
Band 5	£567
Band 6	£583
Band 7	£600
Leather Group 1	£775



MU/7A23
Fully Upholstered
Black Fixed Arms

Band 1	£576
Band 2	£586
Band 3	£606
Band 4	£624
Band 5	£638
Band 6	£658
Band 7	£673
Leather Group 1	£849



MU/7A24
Fully Upholstered
Height Adjustable Arms

Band 1	£609
Band 2	£620
Band 3	£638
Band 4	£658
Band 5	£673
Band 6	£691
Band 7	£706
Leather Group 1	£882



MU/7A25
Fully Upholstered
4D Multi-function Arms

Band 1	£642
Band 2	£658
Band 3	£674
Band 4	£692
Band 5	£707
Band 6	£727
Band 7	£739
Leather Group 1	£918



MUM/7
Mesh Back

Band 1	£504
Band 2	£516
Band 3	£533
Band 4	£550
Band 5	£567
Band 6	£583
Band 7	£600
Leather Group 1	£775



MUM/7A23
Mesh Back
Black Fixed Arms

Band 1	£576
Band 2	£586
Band 3	£606
Band 4	£624
Band 5	£638
Band 6	£658
Band 7	£673
Leather Group 1	£849



MUM/7A24
Mesh Back
Height Adjustable Arms

Band 1	£609
Band 2	£620
Band 3	£638
Band 4	£658
Band 5	£673
Band 6	£691
Band 7	£706
Leather Group 1	£882



MUM/7A25
Mesh Back
4D Multi-function Arms

Band 1	£642
Band 2	£658
Band 3	£674
Band 4	£692
Band 5	£707
Band 6	£727
Band 7	£739
Leather Group 1	£918



MUC
Visitor
Cantilever

Band 1	£460
Band 2	£469
Band 3	£486
Band 4	£505
Band 5	£520
Band 6	£537
Band 7	£553
Leather Group 1	£795



MUMC
Visitor
Mesh Back Cantilever

Band 1	£460
Band 2	£469
Band 3	£486
Band 4	£505
Band 5	£520
Band 6	£537
Band 7	£553
Leather Group 1	£795

PLATINUM PLUS ROUND

TASK & VISITOR



Platinum Plus Round provides the same unique ergonomic properties as the acclaimed original.

- Stylish pyramid base.
- Synchronized seat and back mechanism option (/2).
- Independent seat and back mechanism option (/3).
- Side tension mechanism with seat slide option (/7) - Surcharge.
- Fixed seat mechanism option (/8).
- Extreme comfort and durability.
- Ratchet back height adjustment.
- Reflex Foam Seat Structure.

Prices listed are for our most popular mechanism 3 (independent seat and back), also available /2 (synchronized) and /8 (fixed seat) at the same price. The latest synchronized side tension mechanism /7 is also available.

Product Features



Additional Information

Draughting versions - Fixed seat mechanism option (/8) only.
 Visitor Chair frames in Silver / Black / White / Grey -
 (Chrome Frame £35 surcharge)

Optional Extras

/7	Synchronized side tension mechanism with seat slide - Replace /3 with /7	£54
Y	Sliding seat depth adjustment	£59
L	Inflatable lumbar support	£59
X	Polished aluminium five star base	£60



Task & Visitor Seating

5 Year Guarantee

PLATINUM PLUS ROUND TASK & VISITOR



PPRBH/3
High Back

Band 1	£460
Band 2	£469
Band 3	£486
Band 4	£505
Band 5	£520
Band 6	£537
Band 7	£553
Leather Group 1.....	£731



PPRBH/3A2
High Back
Black Fixed Arms

Band 1	£516
Band 2	£526
Band 3	£544
Band 4	£560
Band 5	£577
Band 6	£594
Band 7	£610
Leather Group 1.....	£789



PPRBH/3A8
High Back
Black Height Adjustable
Arms

Band 1	£545
Band 2	£554
Band 3	£575
Band 4	£591
Band 5	£608
Band 6	£627
Band 7	£640
Leather Group 1.....	£819



PPRBH/3A13
High Back
Height Adjustable
Foldable Arms

Band 1	£564
Band 2	£575
Band 3	£591
Band 4	£609
Band 5	£627
Band 6	£641
Band 7	£660
Leather Group 1.....	£836



PPRBH/3A4D
High Back
4D Multi-function Arms

Band 1	£606
Band 2	£615
Band 3	£635
Band 4	£649
Band 5	£667
Band 6	£688
Band 7	£699
Leather Group 1.....	£877

PPRBR/3

As above with Headrest

Band 1	£553
Band 2	£575
Band 3	£609
Band 4	£640
Band 5	£673
Band 6	£703
Band 7	£734
Leather Group 1.....	£930

PPRBR/3A2

As above with Headrest

Band 1	£609
Band 2	£630
Band 3	£664
Band 4	£696
Band 5	£728
Band 6	£760
Band 7	£791
Leather Group 1.....	£983

PPRBR/3A8

As above with Headrest

Band 1	£640
Band 2	£661
Band 3	£696
Band 4	£729
Band 5	£760
Band 6	£792
Band 7	£823
Leather Group 1.....	£1,020

PPRBR/3A13

As above with Headrest

Band 1	£660
Band 2	£677
Band 3	£716
Band 4	£748
Band 5	£776
Band 6	£809
Band 7	£839
Leather Group 1.....	£1,035

PPRBR/3A4D

As above with Headrest

Band 1	£699
Band 2	£721
Band 3	£755
Band 4	£790
Band 5	£820
Band 6	£853
Band 7	£882
Leather Group 1.....	£1,079



PPRBM/3
Medium Back

Band 1	£434
Band 2	£446
Band 3	£465
Band 4	£482
Band 5	£498
Band 6	£517
Band 7	£533
Leather Group 1.....	£707



PPRBM/3A2
Medium Back
Black Fixed Arms

Band 1	£490
Band 2	£503
Band 3	£519
Band 4	£536
Band 5	£552
Band 6	£572
Band 7	£586
Leather Group 1.....	£762



PPRBM/3A8
Medium Back
Black Height Adjustable
Arms

Band 1	£523
Band 2	£535
Band 3	£552
Band 4	£572
Band 5	£586
Band 6	£606
Band 7	£620
Leather Group 1.....	£796



PPRBM/3A13
Medium Back
Height Adjustable
Foldable Arms

Band 1	£539
Band 2	£552
Band 3	£572
Band 4	£587
Band 5	£606
Band 6	£624
Band 7	£638
Leather Group 1.....	£815



PPRBM/3A4D
Medium Back
4D Multi-function Arms

Band 1	£583
Band 2	£594
Band 3	£611
Band 4	£631
Band 5	£645
Band 6	£664
Band 7	£679
Leather Group 1.....	£856

U
Upholstered
Back Panel

Band 1	£40
Band 2	£54
Band 3	£67
Band 4	£88
Band 5	£103
Band 6	£120
Band 7	£139
Leather Group 1.....	£217

Task & Visitor
Seating



PPRBHXC
Visitor High Back
Cantilever

Band 1	£404
Band 2	£415
Band 3	£432
Band 4	£449
Band 5	£467
Band 6	£483
Band 7	£500
Leather Group 1.....	£675



PPRBMXC
Visitor Medium Back
Cantilever

Band 1	£384
Band 2	£393
Band 3	£411
Band 4	£428
Band 5	£445
Band 6	£464
Band 7	£477
Leather Group 1.....	£656



PPRMD/8
Medium Back
Draughting Chair
(Glides)

Band 1	£500
Band 2	£510
Band 3	£530
Band 4	£546
Band 5	£564
Band 6	£580
Band 7	£595
Leather Group 1.....	£770



PPRMD/8A2
Medium Back
Draughting Chair
Black Fixed Arms
(Glides)

Band 1	£555
Band 2	£571
Band 3	£586
Band 4	£606
Band 5	£620
Band 6	£638
Band 7	£656
Leather Group 1.....	£829

PLATINUM PLUS SQUARED

TASK & VISITOR



Platinum Plus Squared provides the same unique ergonomic properties as the acclaimed original.

- Stylish pyramid base.
- Synchronized seat and back mechanism option (/2).
- Independent seat and back mechanism option (/3).
- Side tension mechanism with seat slide option (/7) - Surcharge.
- Fixed seat mechanism option (/8).
- Extreme comfort and durability.
- Reflex Foam Seat Structure.
- Ratchet back height adjustment.

Prices listed are for our most popular mechanism 3 (independent seat and back), also available /2 (synchronized) and /8 (fixed seat) at the same price. The latest synchronized side tension mechanism /7 is also available.

Product Features



Additional Information

Draughting versions - Fixed seat mechanism option (/8) only.
 Visitor Chair frames in Silver / Black / White / Grey -
 (Chrome Frame £35 surcharge)

Optional Extras

/7	Synchronized side tension mechanism with seat slide - Replace /3 with /7	£54
Y	Sliding seat depth adjustment	£59
L	Inflatable lumbar support	£59
X	Polished aluminium five star base	£60



Task & Visitor Seating

5 Year Guarantee

PLATINUM PLUS SQUARED TASK & VISITOR



PPSH/3
High Back

Band 1	£460
Band 2	£469
Band 3	£486
Band 4	£505
Band 5	£520
Band 6	£537
Band 7	£553
Leather Group 1.....	£731



PPSH/3A2
High Back
Black Fixed Arms

Band 1	£516
Band 2	£526
Band 3	£544
Band 4	£560
Band 5	£577
Band 6	£594
Band 7	£610
Leather Group 1.....	£789



PPSH/3A8
High Back
Black Height Adjustable
Arms

Band 1	£545
Band 2	£554
Band 3	£575
Band 4	£591
Band 5	£608
Band 6	£627
Band 7	£640
Leather Group 1.....	£819



PPSH/3A13
High Back
Height Adjustable
Foldable Arms

Band 1	£564
Band 2	£575
Band 3	£591
Band 4	£609
Band 5	£627
Band 6	£641
Band 7	£660
Leather Group 1.....	£836



PPSH/3A4D
High Back
4D Arms Multi-function
Arms

Band 1	£606
Band 2	£615
Band 3	£635
Band 4	£649
Band 5	£667
Band 6	£688
Band 7	£699
Leather Group 1.....	£877

PPSR/3
As above with Headrest

Band 1	£553
Band 2	£575
Band 3	£609
Band 4	£640
Band 5	£673
Band 6	£703
Band 7	£734
Leather Group 1.....	£930

PPSR/3A2
As above with Headrest

Band 1	£609
Band 2	£630
Band 3	£664
Band 4	£696
Band 5	£728
Band 6	£760
Band 7	£791
Leather Group 1.....	£983

PPSR/3A8
As above with Headrest

Band 1	£640
Band 2	£661
Band 3	£696
Band 4	£729
Band 5	£760
Band 6	£792
Band 7	£823
Leather Group 1.....	£1,020

PPSR/3A13
As above with Headrest

Band 1	£660
Band 2	£677
Band 3	£716
Band 4	£748
Band 5	£776
Band 6	£809
Band 7	£839
Leather Group 1.....	£1,035

PPSR/3A4D
As above with Headrest

Band 1	£699
Band 2	£721
Band 3	£755
Band 4	£790
Band 5	£832
Band 6	£853
Band 7	£882
Leather Group 1.....	£1,079



PPSM/3
Medium Back

Band 1	£434
Band 2	£446
Band 3	£465
Band 4	£482
Band 5	£498
Band 6	£517
Band 7	£533
Leather Group 1.....	£707



PPSM/3A2
Medium Back
Black Fixed Arms

Band 1	£490
Band 2	£503
Band 3	£519
Band 4	£536
Band 5	£552
Band 6	£572
Band 7	£586
Leather Group 1.....	£762



PPSM/3A8
Medium Back
Black Height Adjustable
Arms

Band 1	£523
Band 2	£535
Band 3	£552
Band 4	£572
Band 5	£586
Band 6	£606
Band 7	£620
Leather Group 1.....	£796



PPSM/3A13
Medium Back
Height Adjustable
Foldable Arms

Band 1	£539
Band 2	£552
Band 3	£572
Band 4	£587
Band 5	£606
Band 6	£624
Band 7	£638
Leather Group 1.....	£815



PPSM/3A4D
Medium Back
4D Arms Multi-function
Arms

Band 1	£583
Band 2	£594
Band 3	£611
Band 4	£631
Band 5	£645
Band 6	£664
Band 7	£679
Leather Group 1.....	£856

U
Upholstered
Back Panel

Band 1	£40
Band 2	£54
Band 3	£67
Band 4	£88
Band 5	£103
Band 6	£120
Band 7	£139
Leather Group 1.....	£217



PPSHXC
Visitor High Back
Cantilever

Band 1	£404
Band 2	£415
Band 3	£432
Band 4	£449
Band 5	£467
Band 6	£483
Band 7	£500
Leather Group 1.....	£675



PPSMXC
Visitor Medium Back
Cantilever

Band 1	£384
Band 2	£393
Band 3	£411
Band 4	£428
Band 5	£445
Band 6	£464
Band 7	£477
Leather Group 1.....	£656



PPSMD/8
Medium Back
Draughting Chair
(Glides)

Band 1	£500
Band 2	£510
Band 3	£530
Band 4	£546
Band 5	£564
Band 6	£580
Band 7	£595
Leather Group 1.....	£770



PPSMD/8A2
Medium Back
Draughting Chair
Black Fixed Arms
(Glides)

Band 1	£555
Band 2	£571
Band 3	£586
Band 4	£606
Band 5	£620
Band 6	£638
Band 7	£656
Leather Group 1.....	£829

Task & Visitor
Seating

PLATINUM ERGO

TASK & VISITOR



Platinum Ergo has all the standard features of the classic Platinum task chair but with the added benefit of enhanced ergonomic properties.

- Independent seat and back mechanism option (/3).
- Synchronized seat and back mechanism option (/2).
- Fixed seat mechanism option (/8).
- One touch back height adjustment.
- Provides full support to upper and lower spine.
- Available in medium or high back options.
- Ratchet back height adjustment.
- Reflex Foam Seat Structure.

Prices listed are for our most popular mechanism 3 (independent seat and back), also available /2 (synchronized) and /8 (fixed seat) at the same price.

Product Features



Additional Information

Draughting versions - Fixed seat mechanism option (/8) only.
 Visitor Chair frames in Silver / Black / White / Grey -
 (Chrome Frame £35 surcharge)

Optional Extras

Y	Sliding seat depth adjustment	£59
L	Inflatable lumbar support	£59
X	Polished aluminium five star base	£60



Task & Visitor Seating



PLH/3
High Back

Band 1	£460
Band 2	£469
Band 3	£486
Band 4	£505
Band 5	£520
Band 6	£537
Band 7	£553
Leather Group 1	£731



PLH/3A2
High Back
Black Fixed Arms

Band 1	£516
Band 2	£526
Band 3	£544
Band 4	£560
Band 5	£577
Band 6	£594
Band 7	£610
Leather Group 1	£789



PLH/3A8
High Back Black
Height Adjustable Arms

Band 1	£545
Band 2	£554
Band 3	£575
Band 4	£591
Band 5	£608
Band 6	£627
Band 7	£640
Leather Group 1	£819



PLH/3A13
High Back
Height Adjustable
Foldable Arms

Band 1	£564
Band 2	£575
Band 3	£591
Band 4	£609
Band 5	£627
Band 6	£641
Band 7	£660
Leather Group 1	£836

PLR/3
As Above with Headrest

Band 1	£553
Band 2	£575
Band 3	£609
Band 4	£640
Band 5	£673
Band 6	£703
Band 7	£734
Leather Group 1	£930

PLR/3A2
As Above with Headrest

Band 1	£609
Band 2	£630
Band 3	£664
Band 4	£696
Band 5	£728
Band 6	£760
Band 7	£791
Leather Group 1	£983

PLR/3A8
As Above with Headrest

Band 1	£640
Band 2	£661
Band 3	£696
Band 4	£729
Band 5	£760
Band 6	£792
Band 7	£823
Leather Group 1	£1,020

PLR/3A13
As Above with Headrest

Band 1	£660
Band 2	£677
Band 3	£716
Band 4	£748
Band 5	£776
Band 6	£809
Band 7	£839
Leather Group 1	£1,035



PLM/3
Medium Back

Band 1	£434
Band 2	£446
Band 3	£465
Band 4	£482
Band 5	£498
Band 6	£517
Band 7	£533
Leather Group 1	£707



PLM/3A2
Medium Back
Black Fixed Arms

Band 1	£490
Band 2	£503
Band 3	£519
Band 4	£536
Band 5	£552
Band 6	£572
Band 7	£586
Leather Group 1	£762



PLM/3A8
Medium Back
Black Height Adjustable Arms

Band 1	£523
Band 2	£535
Band 3	£552
Band 4	£572
Band 5	£586
Band 6	£606
Band 7	£620
Leather Group 1	£796



PLM/3A13
Medium Back
Height Adjustable
Foldable Arms

Band 1	£539
Band 2	£552
Band 3	£572
Band 4	£587
Band 5	£606
Band 6	£624
Band 7	£638
Leather Group 1	£815



PLHXC
Visitor High Back Cantilever

Band 1	£404
Band 2	£415
Band 3	£432
Band 4	£449
Band 5	£467
Band 6	£483
Band 7	£500
Leather Group 1	£675



PLMD/8
Medium Back Draughting Chair
(Glides)

Band 1	£500
Band 2	£510
Band 3	£530
Band 4	£546
Band 5	£564
Band 6	£580
Band 7	£595
Leather Group 1	£770



PLMD/8A2
Medium Back Draughting Chair
Black Fixed Arms (Glides)

Band 1	£555
Band 2	£571
Band 3	£586
Band 4	£606
Band 5	£620
Band 6	£638
Band 7	£656
Leather Group 1	£829

PLATINUM SQUARED TASK & VISITOR

5 Year
Guarantee

Platinum Squared offers all the features and ergonomic benefits of the Platinum Ergo, whilst providing an alternative stylish back design.

- Independent seat and back mechanism option (/3).
- Synchronized seat and back mechanism option (/2).
- Fixed seat mechanism option (/8).
- One touch back height adjustment.
- Available in medium or high back options.
- Ratchet back height adjustment.
- Reflex Foam Seat Structure.

Prices listed are for our most popular mechanism 3 (independent seat and back), also available /2 (synchronized) and /8 (fixed seat) at the same price.

Product Features



Additional Information

Draughting versions - Fixed seat mechanism option (/8) only.
Visitor Chair frames in Silver / Black / White / Grey -
(Chrome Frame £29 surcharge)

Optional Extras

Y	Sliding seat depth adjustment	£59
L	Inflatable lumbar support	£59
X	Polished aluminium five star base	£60



5 Year
Guarantee

PLATINUM SQUARED TASK & VISITOR



PSQH/3
High Back

Band 1	£460
Band 2	£469
Band 3	£486
Band 4	£505
Band 5	£520
Band 6	£537
Band 7	£553
Leather Group 1	£731

PSQR/3
As Above with Headrest

Band 1	£553
Band 2	£575
Band 3	£609
Band 4	£640
Band 5	£673
Band 6	£703
Band 7	£734
Leather Group 1	£930



PSQM/3
Medium Back

Band 1	£434
Band 2	£446
Band 3	£465
Band 4	£482
Band 5	£498
Band 6	£517
Band 7	£533
Leather Group 1	£707



PSQHXC
Visitor High Back Cantilever

Band 1	£404
Band 2	£415
Band 3	£432
Band 4	£449
Band 5	£467
Band 6	£483
Band 7	£500
Leather Group 1	£675



PSQH/3A2
High Back
Black Fixed Arms

Band 1	£516
Band 2	£526
Band 3	£544
Band 4	£560
Band 5	£577
Band 6	£594
Band 7	£610
Leather Group 1	£789

PSQR/3A2
As Above with Headrest

Band 1	£609
Band 2	£630
Band 3	£664
Band 4	£696
Band 5	£728
Band 6	£760
Band 7	£791
Leather Group 1	£983



PSQM/3A2
Medium Back
Black Fixed Arms

Band 1	£490
Band 2	£503
Band 3	£519
Band 4	£536
Band 5	£552
Band 6	£572
Band 7	£586
Leather Group 1	£762



PSQMD/8
Medium Back Draughting Chair
(Glides)

Band 1	£500
Band 2	£510
Band 3	£530
Band 4	£546
Band 5	£564
Band 6	£580
Band 7	£595
Leather Group 1	£770



PSQH/3A8
High Back
Black Height Adjustable
Arms

Band 1	£545
Band 2	£554
Band 3	£575
Band 4	£591
Band 5	£608
Band 6	£627
Band 7	£640
Leather Group 1	£819

PSQR/3A8
As Above with Headrest

Band 1	£640
Band 2	£661
Band 3	£696
Band 4	£729
Band 5	£760
Band 6	£792
Band 7	£823
Leather Group 1	£1,020



PSQM/3A8
Medium Back
Black Height Adjustable
Arms

Band 1	£523
Band 2	£536
Band 3	£552
Band 4	£572
Band 5	£586
Band 6	£606
Band 7	£620
Leather Group 1	£796



PSQMD/8A2
Medium Back Draughting Chair
Fixed Black Arms (Glides)

Band 1	£555
Band 2	£571
Band 3	£586
Band 4	£606
Band 5	£620
Band 6	£638
Band 7	£656
Leather Group 1	£829



PSQH/3A13
High Back
Height Adjustable
Foldable Arms

Band 1	£564
Band 2	£575
Band 3	£591
Band 4	£609
Band 5	£627
Band 6	£641
Band 7	£660
Leather Group 1	£836

PSQR/3A13
As Above with Headrest

Band 1	£660
Band 2	£677
Band 3	£716
Band 4	£748
Band 5	£776
Band 6	£809
Band 7	£839
Leather Group 1	£1,035



PSQM/3A13
Medium Back
Height Adjustable
Foldable Arms

Band 1	£539
Band 2	£552
Band 3	£572
Band 4	£587
Band 5	£606
Band 6	£624
Band 7	£638
Leather Group 1	£815

PLATINUM MESH TASK & VISITOR



Platinum Mesh offers all of the features and ergonomic benefits of the Platinum Ergo whilst providing a modern mesh back.

- Independent seat and back mechanism option (/3)
- One touch back height adjustment
- Integral lumbar support with adjustable angle
- Reflex Foam seat structure
- Optional adjustable Headrest

Product Features



Additional Information

A4D Arm (height and width adjustable / sliding and rotating arm pad).



Optional Extras

Y	Sliding seat depth adjustment	£59
X	Polished Aluminium Five Star Base	£60
R	Headrest	£100



PMH/3 Mesh Back	PMH/3A1 Mesh Back Fixed Arms	PMH/3A8 Mesh Back Height Adjustable Arms	PMH/3A13 Mesh Back Height Adjustable Foldable Arms	PMH/3A4D Mesh Back 4D Multi-functional Arms
Band 1 £445	Band 1 £500	Band 1 £532	Band 1 £551	Band 1 £587
Band 2 £456	Band 2 £510	Band 2 £545	Band 2 £561	Band 2 £598
Band 3 £474	Band 3 £530	Band 3 £561	Band 3 £578	Band 3 £615
Band 4 £492	Band 4 £549	Band 4 £578	Band 4 £596	Band 4 £635
Band 5 £506	Band 5 £563	Band 5 £594	Band 5 £611	Band 5 £649
Band 6 £526	Band 6 £580	Band 6 £611	Band 6 £632	Band 6 £668
Band 7 £544	Band 7 £596	Band 7 £629	Band 7 £645	Band 7 £683
Leather Group 1 £620	Leather Group 1 £674	Leather Group 1 £707	Leather Group 1 £725	Leather Group 1 £763



Camira Blazer Sheffield CUZ1T (Band 4)

5 Year Guarantee

HARLEQUIN MESH TASK & VISITOR

- Ratchet back height adjustment.
- Synchronised side tension mechanism complete with seat slide adjustment.
- Gas lift height adjustment.

Product Features



Additional Information

We recommend that you request fabric samples prior to ordering.

Optional Extras

X Polished aluminium five star base £60



HQHM
Mesh Back

Band 1	£453
Band 2	£465
Band 3	£482
Band 4	£500
Band 5	£517
Band 6	£534
Band 7	£550
Leather Group 1.....	£630



HQHM/8
Mesh Back and A8 Height
Adjustable Arms

Band 1	£536
Band 2	£549
Band 3	£567
Band 4	£583
Band 5	£600
Band 6	£616
Band 7	£635
Leather Group 1.....	£713



HQHM/A13
Mesh Back and A13 Height
Adjustable
Foldable Arms

Band 1	£572
Band 2	£582
Band 3	£600
Band 4	£616
Band 5	£635
Band 6	£649
Band 7	£667
Leather Group 1.....	£748



Gabriel Repetto 01101 (Band 2)

Task & Visitor
Seating

TAG TASK & VISITOR



- Ratchet back height adjustment.
- Independent seat and back adjustment.
- Gas lift height adjustment.

Product Features



Additional Information

We recommend that you request fabric samples prior to ordering. Two Tone Upholstery is available, please contact our Sales Department for further information.

Draughting versions - Fixed seat mechanism option (/8) only. Visitor Chair frames in Chrome only.

Optional Extras

Y	Sliding seat depth adjustment	£59
L	Inflatable lumbar support	£59
X	Polished aluminium five star base	£60
U	Fully Upholstered back	P.O.A.

Prices listed are for our most popular mechanism 3 (independent seat and back), also available /2 (synchronised) and /8 (fixed seat) at the same price.



TAGH/3
High Back
Mechanism 3

Band 1	£415
Band 2	£425
Band 3	£443
Band 4	£463
Band 5	£476
Band 6	£494
Band 7	£510
Leather Group 1.....	£689



TAGH/3A2
High Back
Black Fixed Arms
Mechanism 3

Band 1	£472
Band 2	£482
Band 3	£500
Band 4	£518
Band 5	£534
Band 6	£551
Band 7	£568
Leather Group 1.....	£742



TAGH/3A8
High Back
Black Height Adjustable
Arms
Mechanism 3

Band 1	£500
Band 2	£510
Band 3	£530
Band 4	£546
Band 5	£564
Band 6	£580
Band 7	£595
Leather Group 1.....	£770



TAGH/3A13
High Back
Height Adjustable
Foldable Arms
Mechanism 3

Band 1	£522
Band 2	£534
Band 3	£551
Band 4	£571
Band 5	£584
Band 6	£605
Band 7	£618
Leather Group 1.....	£795



TAGM/3
Medium Back
Mechanism 3

Band 1	£394
Band 2	£407
Band 3	£424
Band 4	£442
Band 5	£460
Band 6	£475
Band 7	£491
Leather Group 1.....	£667



TAGM/3A2
Medium Back
Black Fixed Arms
Mechanism 3

Band 1	£449
Band 2	£463
Band 3	£477
Band 4	£496
Band 5	£511
Band 6	£531
Band 7	£546
Leather Group 1.....	£722



TAGM/3A8
Medium Back
Black Height Adjustable
Arms
Mechanism 3

Band 1	£482
Band 2	£492
Band 3	£510
Band 4	£530
Band 5	£545
Band 6	£564
Band 7	£578
Leather Group 1.....	£754



TAGM/3A13
Medium Back
Height Adjustable
Foldable Arms
Mechanism 3

Band 1	£498
Band 2	£508
Band 3	£529
Band 4	£545
Band 5	£546
Band 6	£578
Band 7	£594
Leather Group 1.....	£769



TAGHXC
Visitor High Back
Cantilever

Band 1	£386
Band 2	£395
Band 3	£415
Band 4	£432
Band 5	£448
Band 6	£467
Band 7	£482
Leather Group 1.....	£659



TAGMD/8
Medium Back Drafting
Chair (Glides)
Mechanism 8

Band 1	£482
Band 2	£492
Band 3	£510
Band 4	£530
Band 5	£545
Band 6	£564
Band 7	£578
Leather Group 1.....	£754



TAGMD/8A2
Medium Back Drafting
Chair Black Fixed Arms
(Glides)
Mechanism 8

Band 1	£534
Band 2	£545
Band 3	£564
Band 4	£580
Band 5	£595
Band 6	£613
Band 7	£631
Leather Group 1.....	£805

5 Year
Guarantee

TAG TASK & VISITOR



Task & Visitor
Seating

Gabriel Repetto 2901 (Band 2)

SANTIS ERGO TASK & VISITOR



Santis Ergo is an exquisitely proportioned chair with superb posture design and engineering quality.

- Offers optimum back support.
- Suited to intense working environments, which demand prolonged periods of sitting.
- Soft touch mesh.
- Adjustable lumbar pad.
- Synchronized side tension mechanism with seat slide and gas lift height adjustment.
- Reflex Foam Seat Structure.

Product Features



Additional Information

A4D Arm (height and width adjustable / sliding and rotating arm pad).

Optional Extras



X	Polished Aluminium Five Star Base	£60
R	Headrest	£100



SIE/7
Mesh Back

Band 1	£468
Band 2	£477
Band 3	£496
Band 4	£516
Band 5	£531
Band 6	£549
Band 7	£566
Leather Group 1	£641

SIE/7A1
Mesh Back
Black Fixed Arms

Band 1	£522
Band 2	£534
Band 3	£551
Band 4	£571
Band 5	£584
Band 6	£605
Band 7	£618
Leather Group 1	£697

SIE/7A8
Mesh Back
Black Height Adjustable
Arms

Band 1	£553
Band 2	£567
Band 3	£583
Band 4	£603
Band 5	£616
Band 6	£636
Band 7	£649
Leather Group 1	£731

SIE/7A13
Mesh Back
Height Adjustable
Foldable Arms

Band 1	£574
Band 2	£583
Band 3	£603
Band 4	£618
Band 5	£636
Band 6	£655
Band 7	£668
Leather Group 1	£750

SIE/7A4D
Mesh Back
4D Multi-function Arms

Band 1	£609
Band 2	£620
Band 3	£638
Band 4	£658
Band 5	£673
Band 6	£691
Band 7	£706
Leather Group 1	£786

Task & Visitor
Seating



Camira Blazer Barnard CUZ2S (Band 4)

Santis Squared is an exquisitely proportioned chair with superb posture design and engineering quality.

- Offers optimum back support.
- Suited to intense working environments, which demand prolonged periods of sitting.
- Soft touch mesh.
- Adjustable lumbar pad.
- Synchronized side tension mechanism with seat slide and gas lift height adjustment.
- Reflex Foam Seat Structure.

Product Features



Additional Information

A4D Arm (height and width adjustable / sliding and rotating arm pad).

Optional Extras



X	Polished Aluminium Five Star Base	£60
R	Headrest	£100



SIS/7
Mesh Back

Band 1	£468
Band 2	£477
Band 3	£496
Band 4	£515
Band 5	£531
Band 6	£549
Band 7	£566
Leather Group 1	£641

SIS/7A1
Mesh Back
Black Fixed Arms

Band 1	£522
Band 2	£534
Band 3	£551
Band 4	£569
Band 5	£584
Band 6	£605
Band 7	£618
Leather Group 1	£697

SIS/7A8
Mesh Back
Black Height Adjustable
Arms

Band 1	£553
Band 2	£567
Band 3	£583
Band 4	£603
Band 5	£616
Band 6	£636
Band 7	£649
Leather Group 1	£731

SIS/7A13
Mesh Back
Height Adjustable
Foldable Arms

Band 1	£574
Band 2	£583
Band 3	£603
Band 4	£618
Band 5	£636
Band 6	£655
Band 7	£668
Leather Group 1	£750

SIS/7A4D
Mesh Back
4D Multi-function Arms

Band 1	£609
Band 2	£620
Band 3	£638
Band 4	£658
Band 5	£673
Band 6	£691
Band 7	£706
Leather Group 1	£786



Gabriel Crisp 04601 (Band 4)

ADLINGTON TASK & VISITOR

5 Year
Guarantee

As a very competitively priced product the Adlington range offers exceptional value in terms of quality and posture design.

- Designed for ease of use.
- Incorporates seat height adjustment.
- Fixed seat /adjustable back mechanism option (/4).
- Independent seat and back mechanism option (/9).
- Available with or without fixed arms.
- The ideal choice for an everyday work chair.
- Handwheel back height adjustment.

Product Features



Additional Information

Draughting versions - Mechanism option (/4) only.
Visitor Chair frames in Silver / Black / White / Grey -
(Chrome Frame £29 surcharge)

Optional Extras

Y	Sliding seat depth adjustment	£59
L	Inflatable lumbar support	£59
X	Polished aluminium five star base	£60





AO/4
High Back
Mechanism 4

Band 1	£251
Band 2	£262
Band 3	£279
Band 4	£300
Band 5	£314
Band 6	£331
Band 7	£349
Leather Group 1	£530



AO/4A2
High Back
Black Fixed Arms
Mechanism 4

Band 1	£306
Band 2	£318
Band 3	£333
Band 4	£355
Band 5	£369
Band 6	£387
Band 7	£404
Leather Group 1	£584



AO/4A8
High Back
Black Height Adjustable Arms
Mechanism 4

Band 1	£337
Band 2	£352
Band 3	£367
Band 4	£386
Band 5	£401
Band 6	£421
Band 7	£434
Leather Group 1	£615



AO/4A13
High Back
A13 Height Adjustable Foldable
Arms Mechanism 4

Band 1	£361
Band 2	£370
Band 3	£388
Band 4	£407
Band 5	£423
Band 6	£438
Band 7	£456
Leather Group 1	£637



AO/9
High Back
Mechanism 9

Band 1	£270
Band 2	£280
Band 3	£301
Band 4	£318
Band 5	£332
Band 6	£353
Band 7	£367
Leather Group 1	£549



AO/9A2
High Back
Black Fixed Arms
Mechanism 9

Band 1	£326
Band 2	£335
Band 3	£356
Band 4	£371
Band 5	£388
Band 6	£407
Band 7	£423
Leather Group 1	£605



AO/9A8
High Back
Black Height Adjustable Arms
Mechanism 9

Band 1	£361
Band 2	£370
Band 3	£388
Band 4	£407
Band 5	£423
Band 6	£438
Band 7	£456
Leather Group 1	£637



AO/9A13
High Back
A13 Height Adjustable Foldable
Arms Mechanism 9

Band 1	£376
Band 2	£388
Band 3	£407
Band 4	£424
Band 5	£438
Band 6	£460
Band 7	£474
Leather Group 1	£656



AOC
Visitor High Back Cantilever

Band 1	£250
Band 2	£261
Band 3	£278
Band 4	£299
Band 5	£312
Band 6	£330
Band 7	£349
Leather Group 1	£530



AOC/A2
Visitor High Back Cantilever
Black Fixed Arms

Band 1	£305
Band 2	£316
Band 3	£332
Band 4	£353
Band 5	£367
Band 6	£386
Band 7	£401
Leather Group 1	£582



AOD/4
Draughting Chair (Glides)

Band 1	£352
Band 2	£362
Band 3	£377
Band 4	£395
Band 5	£413
Band 6	£429
Band 7	£446
Leather Group 1	£629



AOD/4A2
Draughting Chair Black Fixed
Arms (Glides)

Band 1	£404
Band 2	£415
Band 3	£432
Band 4	£449
Band 5	£467
Band 6	£483
Band 7	£500
Leather Group 1	£679

ADLINGTON MESH TASK & VISITOR

5 Year
Guarantee

The compact design of the Adlington Mesh incorporates a posture design and seat comfort usually associated with higher value models.

- Hand wheel back height adjustment.
- Fixed seat /adjustable back mechanism (/4).
- Independent seat and back mechanism option (/9).
- Gas height adjustment.

Product Features



Additional Information

Draughting versions - Mechanism option (/4) only.

Optional Extras

Y	Sliding seat depth adjustment	£59
X	Polished aluminium five star base	£60



5 Year
Guarantee

ADLINGTON MESH TASK & VISITOR



AM/4
High Back
Mechanism 4

Band 1	£321
Band 2	£330
Band 3	£349
Band 4	£365
Band 5	£384
Band 6	£400
Band 7	£417
Leather Group 1	£507



AM/4A2
High Back
Black Fixed Arms
Mechanism 4

Band 1	£367
Band 2	£377
Band 3	£395
Band 4	£415
Band 5	£429
Band 6	£448
Band 7	£465
Leather Group 1	£554



AM/4A8
High Back
Black Height Adjustable Arms
Mechanism 4

Band 1	£407
Band 2	£419
Band 3	£434
Band 4	£453
Band 5	£469
Band 6	£486
Band 7	£504
Leather Group 1	£594



AM/4A13
High Back
Black Height Adjustable &
Foldable Arms
Mechanism 4

Band 1	£428
Band 2	£438
Band 3	£456
Band 4	£474
Band 5	£491
Band 6	£507
Band 7	£526
Leather Group 1	£616



AM/9
High Back
Mechanism 9

Band 1	£337
Band 2	£352
Band 3	£367
Band 4	£386
Band 5	£401
Band 6	£421
Band 7	£434
Leather Group 1	£526



AM/9A2
High Back
Black Fixed Arms
Mechanism 9

Band 1	£387
Band 2	£396
Band 3	£417
Band 4	£433
Band 5	£449
Band 6	£468
Band 7	£483
Leather Group 1	£575



AM/9A8
High Back
Black Height Adjustable Arms
Mechanism 9

Band 1	£425
Band 2	£435
Band 3	£454
Band 4	£473
Band 5	£488
Band 6	£506
Band 7	£522
Leather Group 1	£613



AM/9A13
High Back
Black Height Adjustable &
Foldable Arms
Mechanism 9

Band 1	£445
Band 2	£461
Band 3	£475
Band 4	£494
Band 5	£508
Band 6	£530
Band 7	£544
Leather Group 1	£635



AMD/4
Draughting Chair
(Glides)

Band 1	£419
Band 2	£428
Band 3	£446
Band 4	£464
Band 5	£477
Band 6	£496
Band 7	£510
Leather Group 1	£605



AMD/4A2
Draughting Chair
Black Fixed Arms
(Glides)

Band 1	£465
Band 2	£475
Band 3	£492
Band 4	£509
Band 5	£526
Band 6	£544
Band 7	£559
Leather Group 1	£649

Task & Visitor
Seating

BROMLEY 24/7 TASK & VISITOR



A chair that offers superb comfort and functionality.

- Ideal for heavy duty use in Police, Security, Air Traffic Control rooms and other 24 hour working environments.
- Perfect when user needs to be seated for long periods of time.
- 24/7, 365 days a year chair.
- Exceeds level 'S' certification.
- Reflex Foam Seat Structure.

Product Features



Additional Information

The prices highlighted below show 24/7 fabric (Band 3)



AXR24/7
High Back with Headrest

Band 1	£862
Band 2	£878
Band 3 - 24/7	£885
Band 4	£891
Band 5	£965
Band 6	£993
Band 7	£1,023
Leather Group 1	POA



AXR24/7A22
High Back with A22 Multi-function Push Button Arms

Band 1	£987
Band 2	£1,005
Band 3 - 24/7	£1,008
Band 4	£1,015
Band 5	£1,092
Band 6	£1,118
Band 7	£1,146
Leather Group 1	POA



AX24/7
High Back

Band 1	£751
Band 2	£768
Band 3 - 24/7	£773
Band 4	£783
Band 5	£856
Band 6	£885
Band 7	£911
Leather Group 1	POA



AX24/7A22
High Back with A22 Multi-function Push Button Arms

Band 1	£877
Band 2	£893
Band 3 - 24/7	£899
Band 4	£906
Band 5	£982
Band 6	£1,009
Band 7	£1,037
Leather Group 1	POA



Task & Visitor
Seating

Camira 24/7 Flax Eternity FYR18 (Band 3)

5 Year
Guarantee

TAMPER PROOF TASK & VISITOR

Tamper Proof seating selection.

- Ideal for schools, colleges, libraries and public areas.
- Extremely durable / robust.
- Easy to use.
- Tamper Proof fittings.
- TPPBC - Push button height adjustment.

Product Features



Frame Options

290 - Available in Black / Grey / White / Silver



TPPBC
Push Button Tamper Proof

Band 1	£280
Band 2	£293
Band 3	£309
Band 4	£327
Band 5	£342
Band 6	£361
Band 7	£373
Leather Group 1	POA



290
Heavy Duty Student
Chair - Non Tilt

Band 1	£280
Band 2	£293
Band 3	£309
Band 4	£327
Band 5	£342
Band 6	£361
Band 7	£373
Leather Group 1	POA



Gabriel Repetto 02901 (Band 2)

INDUSTRIAL TASK & VISITOR

5 Year
Guarantee

This family of chairs and stools are produced with moulded polyurethane seats and backs.

- Wipe-clean, chemical resistant surfaces.
- Ideal for laboratory, commercial and health care use.
- Textured surface helps prevent slipping when seated.



INPU/16
Operator Task Chair with
Gas Height Adjustment and
Back Rest Adjustment in
Height and Rake
£290



INDPU/16
High Level Work Chair with
Gas Height Adjustable and
Back Rest Adjustment in
Height and Rake (Glides)
£369



INS/P
Perch Stool with Gas Height
Adjustment (Glides)
£228



INDS/P
High Level Perch Stool with
Gas Height Adjustment
(Glides)
£308



5 Year
Guarantee

LS37 TASK & VISITOR

Thanks to its active movement, LS37 helps to provide a healthy sitting experience. With its' smooth motion and practicality, the pivoting base allows the user to sit with an open leg angle which helps to alleviate pressure placed on hips and lower back, as well as feet, ankles and legs; comparative to the detriment of sitting with a traditional posture. The stool can also be used as a 'perch' when using a Sit/Stand desk with its height adjustable column.

Product Features



Movement



LS37A
Pivoting Stool

Band 1	£564
Band 2	£583
Band 3	£603
Band 4	£624
Band 5	£641
Band 6	£662
Band 7	£682



INTRODUCTION

CONFERENCE, MEETING & CAFÉ

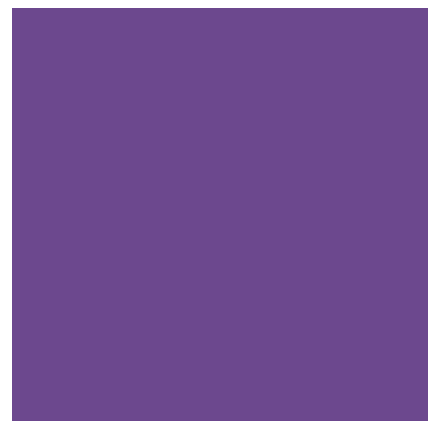
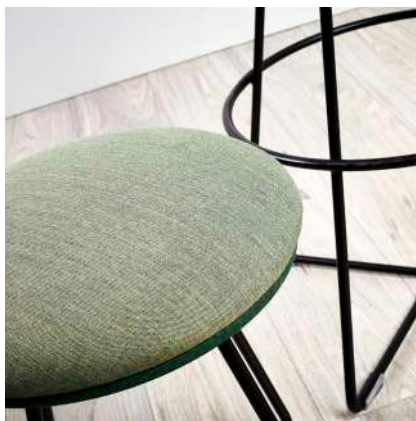
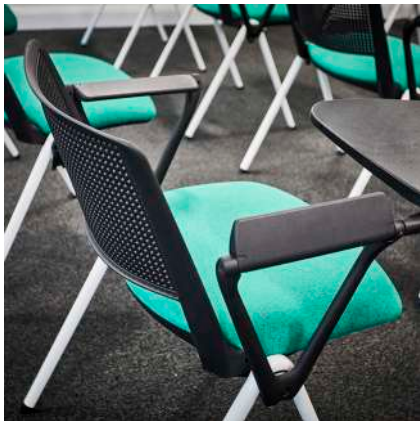
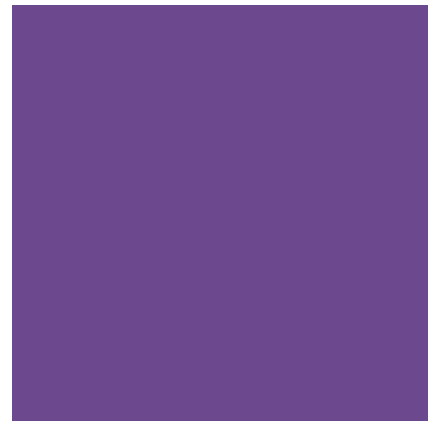

Conference,
Meeting &
Café Seating



Selected items within this range are stackable. These items are identified within the product description.

For further information regarding stacking quantity - Please contact our Sales Department.



Items are available in a variety of fabrics. A number of products possess certain upholstery restrictions - these are therefore available in selected fabrics only and are identified within this brochure.

For further information regarding fabric suitability - Please contact our Sales Department.



Arms are available on designated product ranges as indicated within the relevant product thumbnails. Colour / Finish options are indicated on relevant product pages - where applicable.

For further information regarding Arm options - Please contact our Sales Department.



Feet are available on designated product ranges as indicated within the relevant product thumbnails. Colour / Finish options are indicated on relevant product pages - where applicable.

For further information regarding Feet options - Please contact our Sales Department.



Items include Reflex Foam Structure as standard.

Level 'S' tested to BS5459: Part 2: 2000.

Extreme Comfort.

Consistent Shape Retention.

Durability and long life.

Excellent Fire Retardant Properties.

We recommend that you request fabric samples prior to ordering.

Two tone upholstery is available on selected products. Please contact our Sales Department for further information.

You can find dimensions for all products in the technical data section of this brochure.

Please Note: All images shown are for illustrative purposes.

Some aspects of certain products may differ. Please contact our customer services department with any queries.

KAST

CONFERENCE, MEETING & CAFÉ



Kast is characterised by a single piece shell with a choice of mechanism which is concealed within the seat and simply adjusted by semi concealed triggers. Kast's strength lies in its innovative high resistance inner structure, adding to the environmental story of the chair.

Available with or without elegant die-cast aluminium armrests in a selection of colours which move with the body of the chair. With the technology hidden inside the shell and covered by a wide range of fabrics the underside is tidy and compact.

Product Features



Frame Colours



Additional Information

The weight activated **Synchronized Mechanism** versions offer customisable height adjustability with both seat and back angle adjustment.

Tilt angles:
18° backrest (Backrest angle locks in 3 positions)
1° seat

The **Visitor Mechanism** provides a fixed height seat with free-float movement.



KASFMA2
High Back Pyramid Base
Synchronized Mechanism

Band 3	£1,522
Band 4	£1,556
Band 5	£1,593
Band 6	£1,629
Band 7	£1,661
Leather Group 1	£2,016



KASFMA1
High Back 5 Star Castor Base
Synchronized Mechanism

Band 3	£1,474
Band 4	£1,509
Band 5	£1,548
Band 6	£1,584
Band 7	£1,616
Leather Group 1	£1,887



KASVMA2
High Back Pyramid Base
Visitor Mechanism

Band 3	£1,455
Band 4	£1,489
Band 5	£1,528
Band 6	£1,562
Band 7	£1,594
Leather Group 1	£1,940



KASLBFMA2
Medium Back
Pyramid Base
Synchronized Mechanism

Band 3	£1,488
Band 4	£1,512
Band 5	£1,537
Band 6	£1,560
Band 7	£1,580
Leather Group 1	£1,982



KASLBFMA1
Medium Back 5 Star
Castor Base
Synchronized Mechanism

Band 3	£1,387
Band 4	£1,406
Band 5	£1,432
Band 6	£1,455
Band 7	£1,476
Leather Group 1	£1,798



KASLBVMA2
Medium Back
Pyramid Base
Visitor Mechanism

Band 3	£1,388
Band 4	£1,409
Band 5	£1,433
Band 6	£1,456
Band 7	£1,477
Leather Group 1	£1,874

5 Year
Guarantee

NEW
PRODUCT

KAST CONFERENCE, MEETING & CAFÉ



Kvadrat Glow 923 Camira Blazer Oriol CUZ18

Conference,
Meeting &
Café Seating

LC11 SLED

CONFERENCE, MEETING & CAFÉ

2 Year Guarantee

The LC11 collection is a contemporary family of chairs offering an elegantly curved, single-piece shell with a variety of frame possibilities. The clean-lined sled frame option accentuates the stool's simplicity and with a choice of two heights, can be matched to most worksurfaces.

Please note vinyl fabrics are subject to a surcharge, please contact our sales department for further information.

Product Features



Plastic Colours



Metal Frame Colours



Additional Information

Available in a variety of fabrics.



LC11M1
Sled Base
650mm Seat Height
Chrome Frame

Price £442



LC11M2
Sled Base
650mm Seat Height
Chrome Frame Upholstered

Band 1 £902
Band 2 £920
Band 3 £945
Band 4 £966
Band 5 £992
Band 6 £1,013
Band 7 £1,035

Vinyl Surcharge £116



LC11N1
Sled Base
800mm Seat Height
Chrome Frame

Price £456



LC11N2
Sled Base
800mm Seat Height
Chrome Frame Upholstered

Band 1 £919
Band 2 £935
Band 3 £959
Band 4 £981
Band 5 £1,006
Band 6 £1,026
Band 7 £1,050

Vinyl Surcharge £116

2 Year
Guarantee

LC11 SLED CONFERENCE, MEETING & CAFÉ



Conference,
Meeting &
Café Seating

LC11 STAR CONFERENCE, MEETING & CAFÉ

2 Year
Guarantee

The LC11 collection is a contemporary family of chairs offering an elegantly curved, single-piece shell with a variety of frame possibilities. When specified with the sleek pyramidal four and five star bases, the chairs come to life; ranging from simple swivel movement to mobile, gas height adjustability actions. Frames are available with either simple glides or stylish castors.

Please note vinyl fabrics are subject to a surcharge, please contact our sales department for further information.

Product Features



Additional Information
Available in a variety of fabrics.

Metal Frame Colours



White



Black



Polished

LC11Q4 only



LC11F3
4 Star 180° Swivel
Black or White Frame
Upholstered

Band 1	£1,128
Band 2	£1,145
Band 3	£1,168
Band 4	£1,190
Band 5	£1,217
Band 6	£1,237
Band 7	£1,259

Vinyl Surcharge £116



LC11G3
4 Star 360° Swivel
Black or White Frame
Upholstered

Band 1	£1,128
Band 2	£1,145
Band 3	£1,168
Band 4	£1,190
Band 5	£1,217
Band 6	£1,237
Band 7	£1,259

Vinyl Surcharge £116



LC11Q3
5 Star 360° Swivel
Black or White Frame with Gas
Lift and Soft Rubber Castors
Upholstered

Band 1	£1,223
Band 2	£1,238
Band 3	£1,263
Band 4	£1,285
Band 5	£1,310
Band 6	£1,331
Band 7	£1,352

Vinyl Surcharge £116



LC11Q4
5 Star 360° Swivel
Polished Frame with Gas Lift
and Soft Rubber Castors
Upholstered

Band 1	£1,310
Band 2	£1,327
Band 3	£1,348
Band 4	£1,371
Band 5	£1,396
Band 6	£1,418
Band 7	£1,440

Vinyl Surcharge £116



Kvadrat Canvas 2 0954 (Band 4) with White 4 Star Swivel Base



LC11 WOOD CONFERENCE, MEETING & CAFÉ

The LC11 collection is a contemporary family of chairs offering an elegantly curved, single-piece shell.

The sculpted polymer shell is available in an assortment of colours or can be specified in a selection of upholstery fabrics, whilst the wooden frames are offered in two styles. These can be specified in either complementary woodgrain or opaque finishes that add a natural warmth to each product.

Please note vinyl fabrics are subject to a surcharge, please contact our sales department for further information.

Product Features



Plastic Colours



Wood Frame Colours



Additional Information

Available in a variety of fabrics.



LC11H1
Wooden 4 Leg

Price £411



LC11H2
Wooden 4 Leg
Upholstered

Band 1	£873
Band 2	£892
Band 3	£916
Band 4	£937
Band 5	£948
Band 6	£963
Band 7	£1,006

Vinyl Surcharge £116



Sky Blue and Grey Plastic with Natural Legs

LC11 CHROME

CONFERENCE, MEETING & CAFÉ



The LC11 collection is a contemporary family of chairs offering an elegantly curved, single-piece shell with a variety of frame possibilities. Steel framed chairs are available in either four or sled legged options that are styled to match the sweeping shape of the seat. Chrome finished models are designed to stack and the sled framed chairs are offered with and without arms.

Please note vinyl fabrics are subject to a surcharge, please contact our sales department for further information.

Product Features



Additional Information
Painted frames available on 4 Leg only and coordinate with matching shells.
Minimum order quantity - multiples of 2

Plastic Colours



Metal Frame Colours



LC11A1
Chrome 4 Leg Frame

Price £311



LC11B1
Chrome Sled Frame
(Stacks 6 as standard or 10 per Trolley)

Price £391



LC11C1
Chrome Sled Frame with Arms
(Stacks 8 as standard or 10 per Trolley)

Price £448



LC11D
Sled Link in Grey

Price £211



LC11E
Trolley in Satin Steel

Price £471

2 Year
Guarantee

LC11 CHROME

CONFERENCE, MEETING & CAFÉ



Conference,
Meeting &
Café Seating

From L/R White Plastic with Chrome 4 Leg Frame and Grey Plastic with Chrome Sled Frame

LC11 STOOL

CONFERENCE, MEETING & CAFÉ



The LC11 collection is a contemporary family of chairs offering an elegantly curved, single-piece shell with a variety of frame possibilities. The sculpted polymer shell is available in an assortment of colours or can be specified in a selection of upholstery fabrics, whilst the wooden frames are offered in two heights matching the style of the LC11H series. These can be specified in either complementary woodgrain or opaque finishes that add a natural warmth to each product.

Please note vinyl fabrics are subject to a surcharge, please contact our sales department for further information.

Product Features



Plastic Colours



Wood Frame Colours



Additional Information

Footrest available in Chrome only.



LC11K1
Wooden 4 Leg
650mm Seat Height

Price £530



LC11K2
Wooden 4 Leg
660mm Seat Height
Upholstered

Band 1 £992
Band 2 £1,007
Band 3 £1,031
Band 4 £1,054
Band 5 £1,080
Band 6 £1,100
Band 7 £1,121

Vinyl Surcharge £116



LC11L1
Wooden 4 Leg
800mm Seat Height

Price £572



LC11L2
Wooden 4 Leg
810mm Seat Height
Upholstered

Band 1 £1,035
Band 2 £1,051
Band 3 £1,075
Band 4 £1,096
Band 5 £1,121
Band 6 £1,144
Band 7 £1,165

Vinyl Surcharge £116

2 Year
Guarantee

LC11 STOOL

CONFERENCE, MEETING & CAFÉ



Conference,
Meeting &
Café Seating

From L/R Panaz Cadet Zest 901 Silver (Band 2) with Bleached Beech Legs and Kvadrat Steelcut 2 0545 (Band 3) with Graphite Legs

LC11 GAS

CONFERENCE, MEETING & CAFÉ



The LC11 collection is a contemporary family of chairs offering an elegantly curved, single-piece shell with a variety of frame possibilities. The LC11P stools are adjustable with a simple 'one-touch' action, allowing them to be raised to the desired heights. They are fitted with a flat base and foot ring that enables users to swivel in a complete circle when seated. As with the other models within the LC11 family, the seat shells are offered in an assortment of colours or fully upholstered.

Please note vinyl fabrics are subject to a surcharge, please contact our sales department for further information.

Product Features



Additional Information
Available in a variety of fabrics.

Plastic Colours



Metal Frame Colours



LC11P1
650mm - 840mm Seat Height
Gas Lift
Price £977

LC11P2
660mm - 840mm Seat Height
Gas Lift Upholstered

Band 1	£1,440
Band 2	£1,455
Band 3	£1,479
Band 4	£1,502
Band 5	£1,527
Band 6	£1,549
Band 7	£1,569



Conference,
Meeting &
Cafe Seating



LC17 WOOD CONFERENCE, MEETING & CAFÉ

The LC17 is part dining chair, part easy chair, but wholly suitable for all relaxed situations. The upholstered seat is as comfortable as an armchair, but the 4-legged wooden frame gives it a streamlined design, allowing it to be used as a dining chair.

Please note vinyl fabrics are not available.

Product Features



Wood Frame Colours



Additional Information

Available in a variety of fabrics.



LC17A
Wooden 4 Leg

Band 1	£1,403
Band 2	£1,425
Band 3	£1,456
Band 4	£1,487
Band 5	£1,519
Band 6	£1,569
Band 7	£1,578



From L/R Camira Blazer Cardiff CUZ1N and Camira Blazer Dunhurst CUZ58 (Band 4) with White Legs

LC18 WOOD

CONFERENCE, MEETING & CAFÉ



The LC18 stool is designed to suit all interior needs. Its ergonomic foam padded seat provides maximum comfort and is an excellent choice of stool for kitchens and lounge bars.

Product Features



Wood Frame Colours



Natural
Oak

Additional Information

Footrest available in Chrome only. Available in a variety of fabrics.



LC18C

Wooden 4 Leg Pyramid
670mm Seat Height

Band 1.....	£1,044
Band 2.....	£1,051
Band 3.....	£1,061
Band 4.....	£1,072
Band 5.....	£1,081
Band 6.....	£1,091
Band 7.....	£1,102



LC18D

Wooden 4 Leg Pyramid
820mm Seat Height

Band 1.....	£1,094
Band 2.....	£1,102
Band 3.....	£1,110
Band 4.....	£1,120
Band 5.....	£1,129
Band 6.....	£1,141
Band 7.....	£1,149



From L/R Camira Era Everlasting CSE10 (Band 1) and Camira Era Aeon CSE20 (Band 1) with Natural Oak Legs

2 Year
Guarantee

LC18 WOOD CONFERENCE, MEETING & CAFÉ



Conference,
Meeting &
Café Seating

LG4 PLASTIC CONFERENCE, MEETING & CAFÉ



The LG4 collection has been developed to add modern style, comfort and practicality to any interior. Beautiful design is complemented by utilising the latest materials science to provide lightweight yet strong models that will stand the test of time. The LG4E1 offers a single piece, sculpted seat shell that is available in an array of striking colours. The stylised moulded four legged frame pitches the seat at the perfect angle and is available in simple black or white options.

Plastic Seat Colours

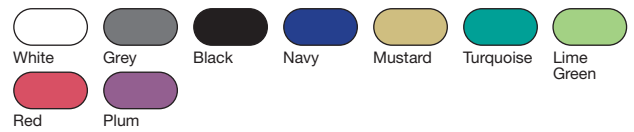

Plastic Frame Colours



LG4E1
4 Leg Plastic Frame

Price £297



LG4E1UPH
Upholstered 4 Leg Plastic Frame

Band 1 £374
 Band 2 £402
 Band 3 £437
 Band 4 £469
 Band 5 £507
 Band 6 £539
 Band 7 £572



Turquoise, Plum and Mustard Plastic Seat with Black Plastic Frame

Conference,
Meeting &
Café Seating



LG4 WOOD CONFERENCE, MEETING & CAFÉ

The LG4 collection has been developed to add modern style, comfort and practicality to any interior. Beautiful design is complemented by utilising the latest materials science to provide lightweight yet strong models that will stand the test of time.

Plastic Seat Colours

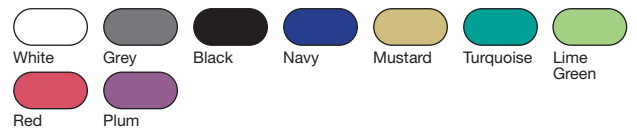

Wood Frame Colours



LG4C1
Wooden 4 Leg

Price £260



LG4K1
Wooden 680mm Seat Height

Price £326



LG4C1UPH
Upholstered

Band 1 £345
Band 2 £371
Band 3 £407
Band 4 £440
Band 5 £476
Band 6 £509
Band 7 £532



LG4K1UPH
Upholstered 680mm Seat Height

Band 1 £370
Band 2 £394
Band 3 £431
Band 4 £464
Band 5 £502
Band 6 £534
Band 7 £567



Plum, Grey and Lime Green Plastic Seat with Beech Frame

Conference,
Meeting &
Café Seating

LG4 CHROME

CONFERENCE, MEETING & CAFÉ



The LG4 collection has been developed to add modern style, comfort and practicality to any interior. Beautiful design is complemented by utilising the latest materials science to provide lightweight yet strong models that will stand the test of time. In its simplest form, this family offers steel four legged or sled framed options featuring a clean, bright chrome finish. These lightweight, yet durable chairs are designed to stack; simply reducing the space taken when not in use.

Plastic Seat Colours

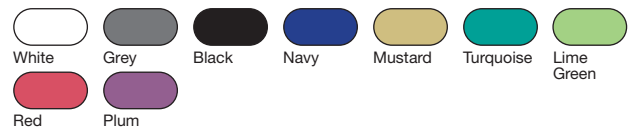

Metal Frame Colours



Product Features



LG4A1
Chrome 4 Leg

Price £246



LG4B1
Chrome Sled Frame

Price £260



LG4M1
Chrome Sled Frame
655mm Seat Height

Price £294



LG4J1
Chrome Sled Frame
760mm Seat Height

Price £326



LG4A1UPH
Upholstered
Chrome 4 Leg

Band 1 £332
Band 2 £360
Band 3 £394
Band 4 £428
Band 5 £465
Band 6 £498
Band 7 £532



LG4B1UPH
Upholstered
Chrome Sled Frame

Band 1 £351
Band 2 £379
Band 3 £414
Band 4 £447
Band 5 £485
Band 6 £517
Band 7 £550



LG4M1UPH
Upholstered
Chrome Sled Frame
Mid Height

Band 1 £351
Band 2 £376
Band 3 £411
Band 4 £445
Band 5 £483
Band 6 £516
Band 7 £549



LG4J1UPH
Upholstered
Chrome Sled Frame
760mm Seat Height

Band 1 £380
Band 2 £407
Band 3 £443
Band 4 £475
Band 5 £511
Band 6 £546
Band 7 £578

Conference,
Meeting &
Cafe Seating

2 Year
Guarantee

NEW
PRODUCT

CONFERENCE, MEETING & CAFÉ



From L/R White Plastic with Chrome Sled Frame and Red Plastic with Chrome 4 Leg Frame.

Conference,
Meeting &
Café Seating

LS36

CONFERENCE, MEETING & CAFÉ

2 Year Guarantee

LS36 combines one single shell with several different frames, creating a versatile and multipurpose seating family. LS36 is suitable for use in meeting, waiting and conference rooms, and also in hospitality where it is perfect for cafeterias and bars. Upholstered seat pad is available in a variety of fabrics.

Plastic Shell Colours



Metal Frame Colours



Product Features



Additional Information

Upholstered seat pads (SP) available in a variety of fabrics.



LS36B
4 Leg Frame

Price Without Seat Pad £119



LS36A
A Frame

Price Without Seat Pad £139



LS36C
Sled Leg Frame

Price Without Seat Pad £172



LS36D
4 Leg Stool
755mm Seat Height
Price Without Seat Pad £235

LS36BSP 4 Leg Frame with Seat Pad	
Band 1	£179
Band 2	£192
Band 3	£209
Band 4	£226
Band 5	£243
Band 6	£259
Band 7	£274
Leather Group 1	POA

LS36ASP A Frame with Seat Pad	
Band 1	£200
Band 2	£213
Band 3	£230
Band 4	£246
Band 5	£263
Band 6	£279
Band 7	£294
Leather Group 1	POA

LS36CSP Sled Leg Frame with Seat Pad	
Band 1	£233
Band 2	£247
Band 3	£264
Band 4	£280
Band 5	£299
Band 6	£314
Band 7	£330
Leather Group 1	POA

LS36DSP 4 Leg Stool with Seat Pad	
Band 1	£297
Band 2	£309
Band 3	£327
Band 4	£343
Band 5	£361
Band 6	£376
Band 7	£392
Leather Group 1	POA



From L/R Grey with Chrome A Frame, Avocado with White 4 Leg Frame, White with Chrome Sled Leg Frame and Black with Chrome Sled Leg Frame

2 Year Guarantee

LG1 CONFERENCE, MEETING & CAFÉ

This stylised collection has been developed to offer a distinctive look whilst providing comfort and longevity. The moulded shapes within the shell accentuate the 'plank' effect of the design and create a slip-free surface on which to sit. In its simplest form, this family offers steel four legged or sled framed options featuring a clean, bright chrome finish. These lightweight, yet durable chairs are designed to stack; simply reducing the space taken when not in use.

Plastic Seat Colours

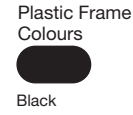
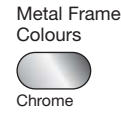

Additional Information
Chairs and stool stack 4 high.



LG1A1
Chrome 4 Leg

Price £230



LG1B1
Chrome Sled Frame

Price £246



LG1G1
Chrome Sled Frame
760mm Seat Height

Price £289



LG1E1
4 Leg Plastic Frame

Price £284

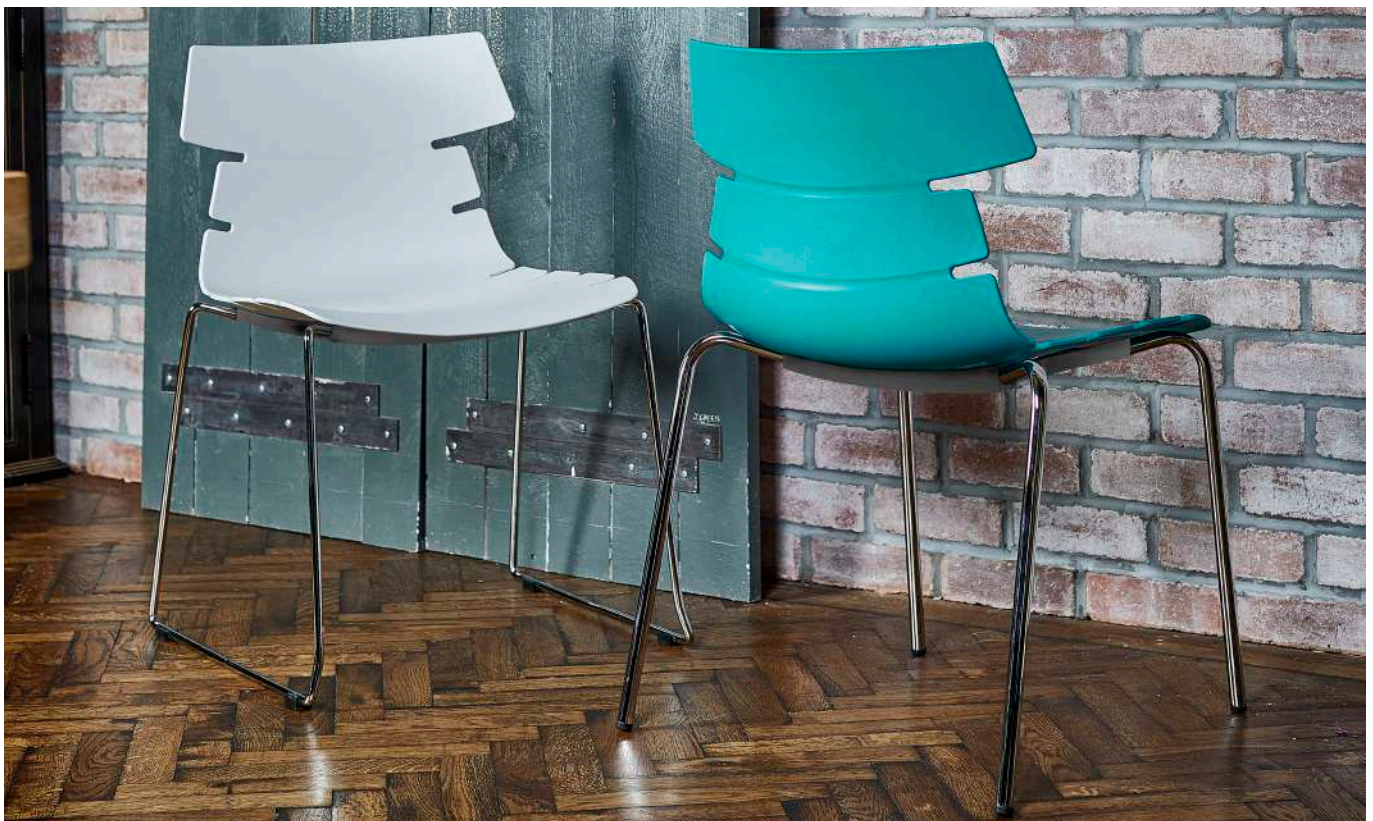

From L/R White Plastic with Chrome Sled Leg Frame and Turquoise with Chrome 4 Leg Frame

Conference,
Meeting &
Café Seating

LG2

CONFERENCE, MEETING & CAFÉ



The LG2 is a re-imagining of the traditional moulded chair with its clean-lines and subtle chevron motif. Its curved 'L' shaped profile allows the back to flex to the users movements whilst cradling them for comfort. This chair is offered with either a steel four legged or sled framed featuring a clean, bright chrome finish. These lightweight, yet durable chairs are designed to stack; simply reducing the space taken when not in use.

Plastic Seat Colours



Metal Frame Colours



Product Features



Additional Information
Chairs and stool stack 4 high.



LG2A
Chrome 4 Leg Frame

Price £289



LG2B
Chrome Sled Frame

Price £304



LG2C
Chrome Sled Frame
760mm Seat Height

Price £485

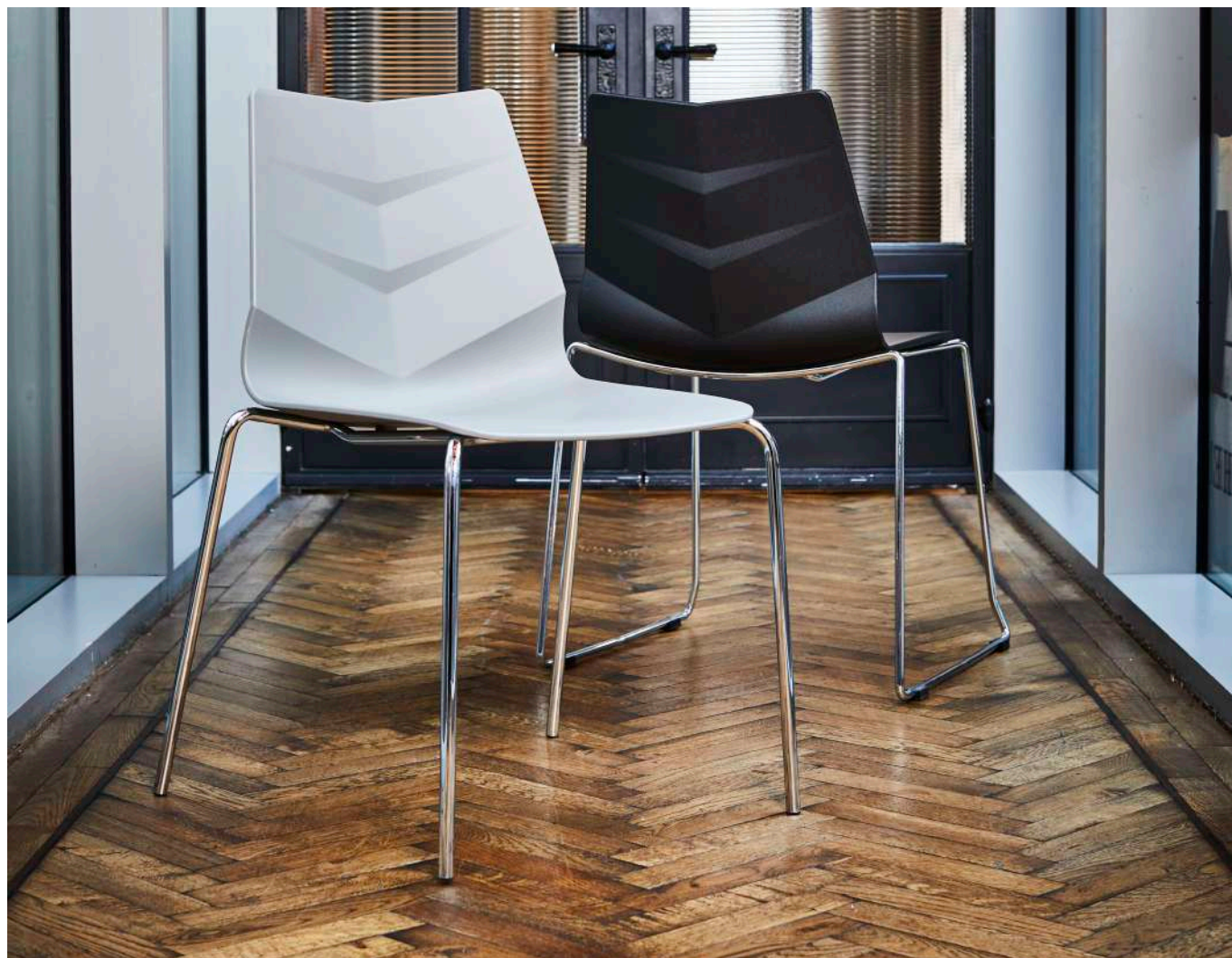

Conference,
Meeting &
Cafe Seating



LC14 STOOL CONFERENCE, MEETING & CAFÉ

This bio-inspired tub chair family is reminiscent of large, exotic tropical flower petals with their organic shape. As well as being hardwearing and strong, the unique wraparound backrest is ergonomically designed to offer exceptional comfort for users. The clean-lined, four-legged frame option accentuates the stool's simplicity and with a choice of two heights, can be matched to most worksurfaces.

Plastic Seat Colours



Metal Frame Colours



LC14F
4 Leg 650mm Seat Height

Price £520



LC14G
4 Leg 810mm Seat Height

Price £544



Conference,
Meeting &
Café Seating

LC14 METAL CONFERENCE, MEETING & CAFÉ



This bio-inspired tub chair family is reminiscent of large, exotic topical flower petals with their organic shape. As well as being hardwearing and strong, the unique wraparound backrest is ergonomically designed to offer exceptional comfort for users. Both sculpted shell and durable four legged frames are available in an array of striking colours.

Plastic Colours

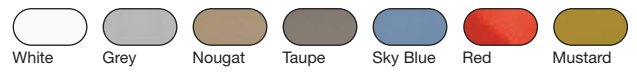

Metal Frame Colours



Additional Information

Painted frames coordinate with matching shells
Minimum order quantity - multiples of 2



LC14B1
Chrome 4 Leg

Price £355

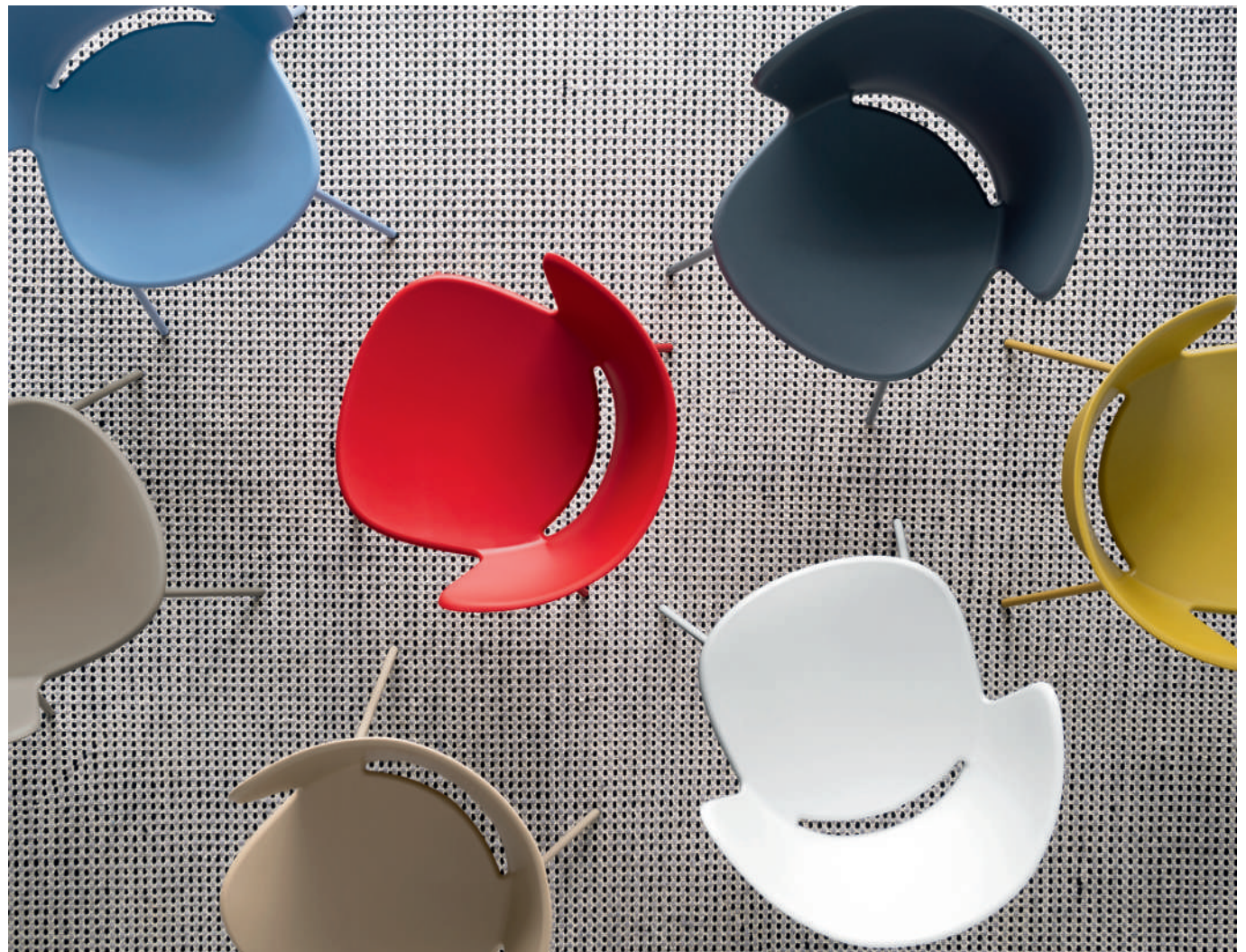

Conference,
Meeting &
Cafe Seating



LC14 WOOD CONFERENCE, MEETING & CAFÉ

This bio-inspired tub chair family is reminiscent of large, exotic topical flower petals with their organic shape. As well as being hardwearing and strong, the unique wraparound backrest is ergonomically designed to offer exceptional comfort for users. This family offers a selection of four-legged wood frame models in a range of finishes adding richness and a natural warmth to the products.

Plastic Colours

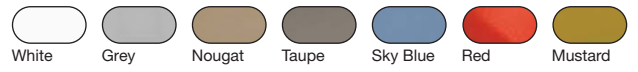

Wood Frame Colours



LC14A
Wooden 4 Leg
with White Cross Frame

Price £565



Conference,
Meeting &
Café Seating

QUS

CONFERENCE, MEETING & CAFÉ



Qus is a vintage-inspired range. The elegant polypropylene shell makes the Qus compact, strong and light, whilst conserving comfort and practicality for daily use. Being available in a variety of colours with multiple frame and seat upholstery options makes Qus the right solution for indoor modern community spaces.

Product Features



Plastic Colours



Metal Frame Colours



Chrome

Wood Frame Colours



Natural

Additional Information

The tube frame options (including stools) stack up to 5 chairs high. Optional seat upholstery available in a variety of fabrics. Optional linking device



QUSL
Chrome 4 Leg Frame

Price £134



QUS4
Chrome Star Base

Price £280



QUSRT
Chrome Sled Frame
with Right Hand Writing Tablet

Price £363



QUSLT
Chrome Sled Frame
with Left Hand Writing Tablet

Price £363



QUSC
Chrome Sled Frame

Price £196



QUSS8
Chrome Sled Frame
630mm Seat Height

Price £219



QUSW
Natural Wooden 4 Leg

Price £335

SP
Chrome Seat Upholstry Kit

Band 1 £57
Band 2 £62
Band 3 £75
Band 4 £88
Band 5 £100
Band 6 £110
Band 7 £121

Conference,
Meeting &
Cafe Seating

2 Year
Guarantee

QUS CONFERENCE, MEETING & CAFÉ

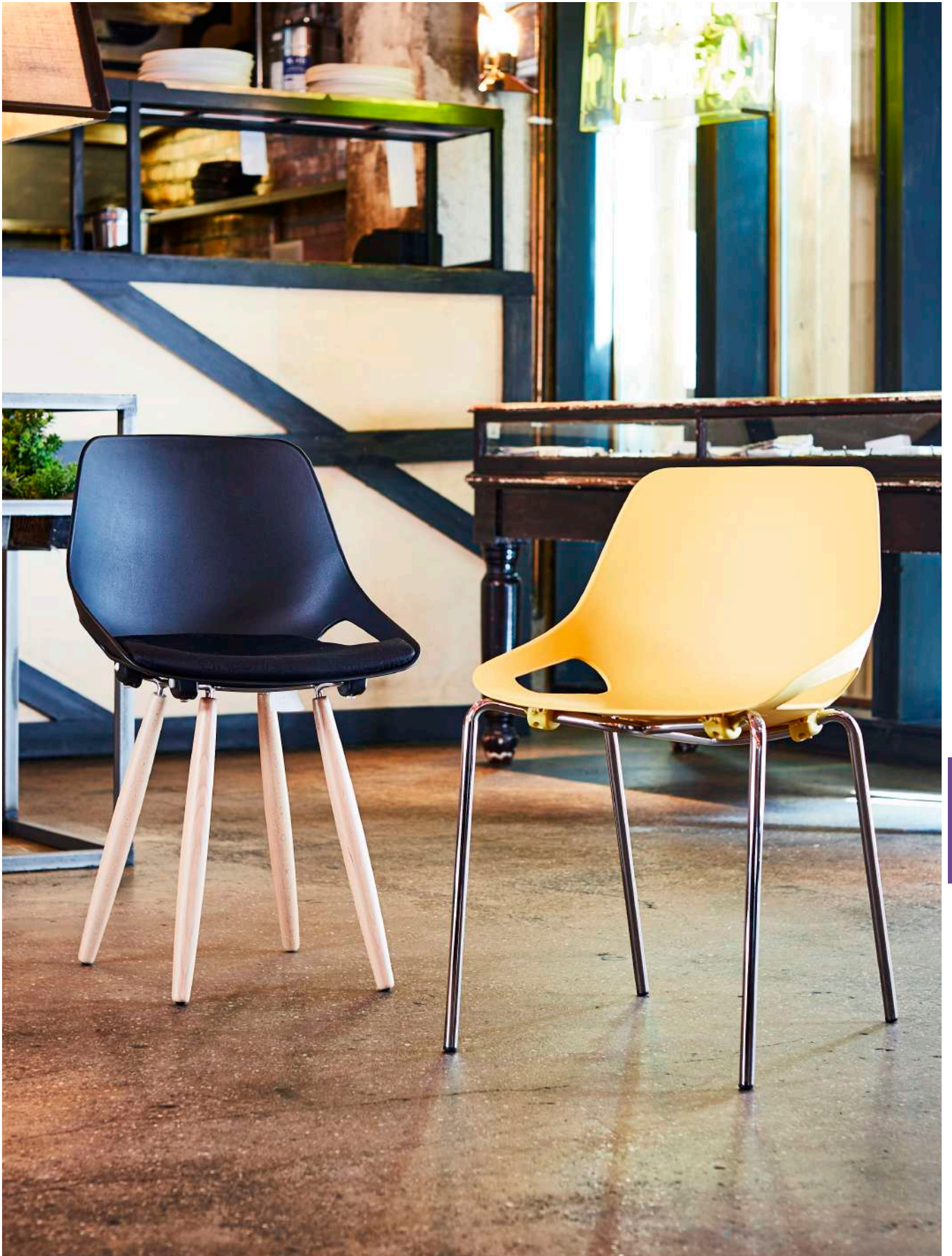

Conference,
Meeting &
Café Seating

From L/R Black Plastic with Wooden 4 Leg Frame and Yellow Plastic with Chrome 4 Leg Frame

LAHR

CONFERENCE, MEETING & CAFÉ



Lahr ticks all the boxes with its exquisite wood or steel frames. With a variety of vibrant polypropylene shells, Lahr can be specified to co-ordinate with commercial or domestic interiors alike. The soft, sculptured shape offers users comfort, as well as being a distinctive decorative motif.

Product Features



Additional Information

Chairs stack up to 4 high (Chrome frame only).
Stool footing Chrome only.

Plastic Seat Colours



Wood Frame Colours



Metal Frame Colours



KA61
Chrome 4 Leg Frame

Price £299



KA6S
Chrome Sled Frame

Price £358



KA6S66
Chrome Sled Frame
660mm Seat Height

Price £443



KA6S80
Chrome Sled Frame
800mm Seat Height

Price £456



KA6W1
Wooden 4 Leg Frame

Price £385



KA6W65
Wooden 4 Leg Frame
650mm Seat Height

Price £534



KA6W80
Wooden 4 Leg Frame
805mm Seat Height

Price £637

Conference,
Meeting &
Café Seating

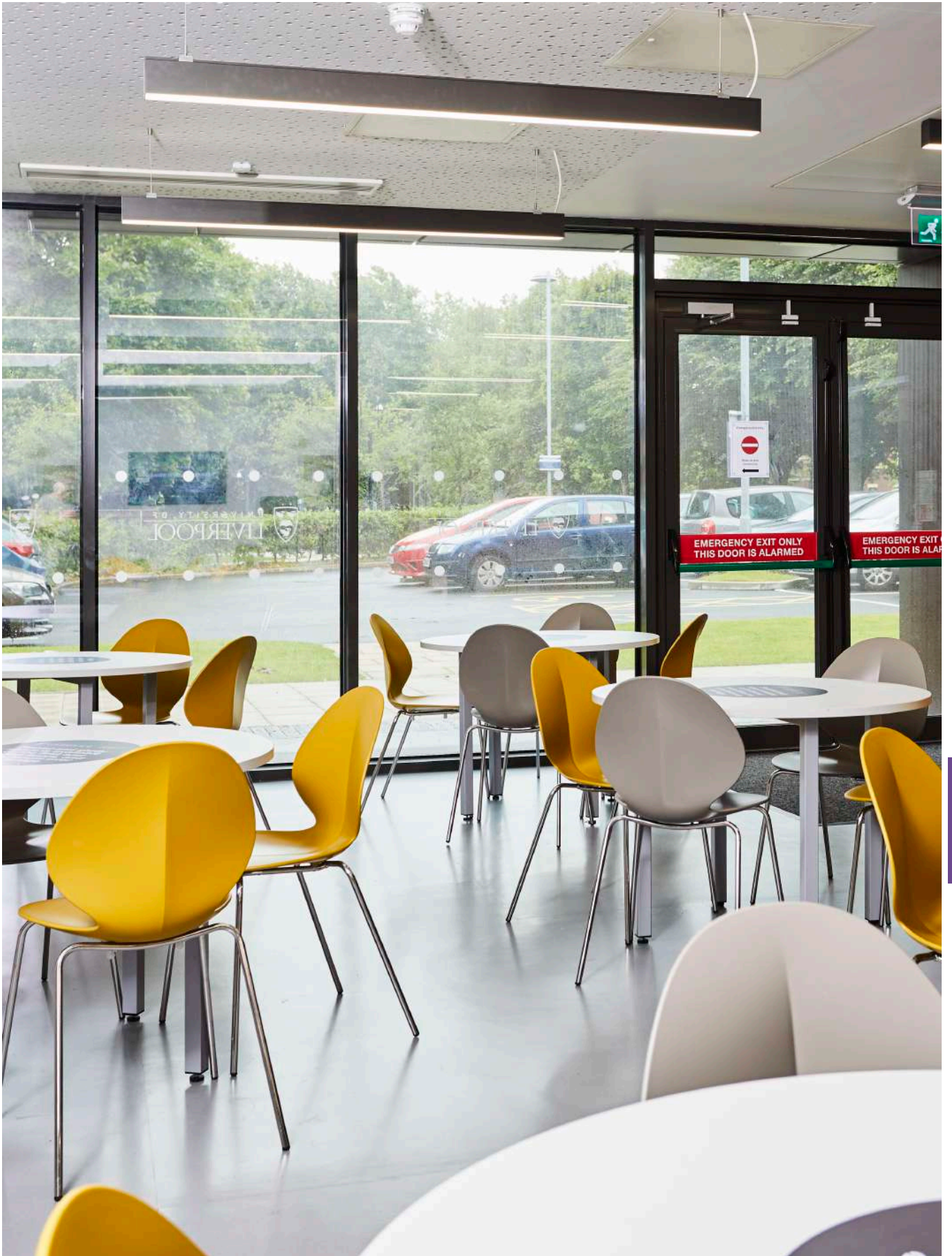

Mustard and Taupe Plastic with Chrome 4 Leg Frame

COSO

CONFERENCE, MEETING & CAFÉ



Coso is a family of products made up of chairs, armchairs and stools, with fiberglass polypropylene shells and metal frames. The idea is to offer a collection of products intentionally limited to a few base models, thanks to the essential design's versatility and to the range of colour combinations between shells and frames. Ability to stack all models.

Plastic Seat Colours



Metal Frame Colours



Product Features



COS4
Chrome 4 Leg Frame

Price £202



COS4A
Chrome 4 Leg with Arms

Price £241



COS65
Chrome Sled Frame
655mm Seat Height

Price £280



COS75
Chrome Sled Frame
755mm Seat Height

Price £301

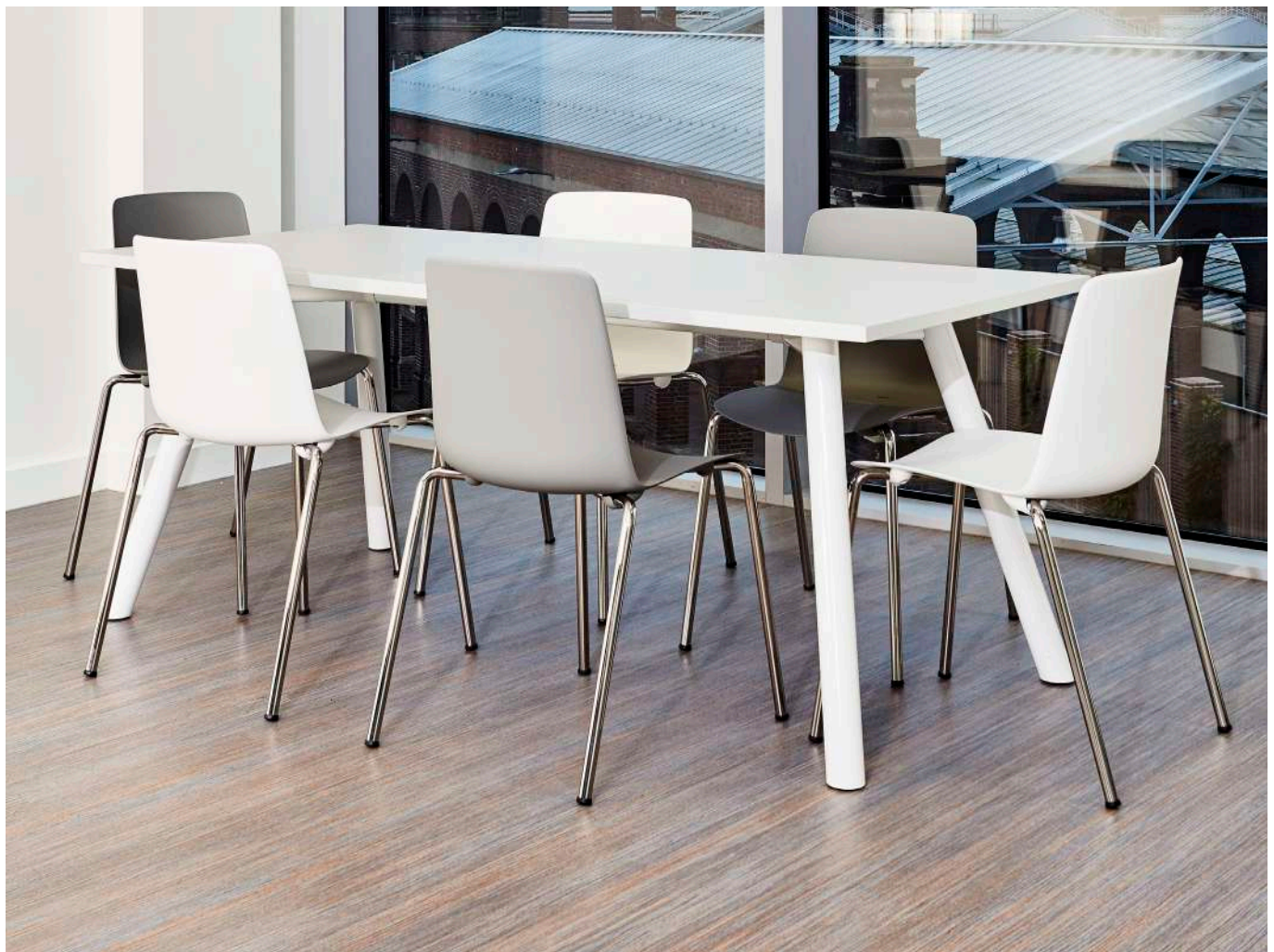

White Plastic and Grey Plastic with Chrome 4 Leg Frame

Conference,
Meeting &
Cafe Seating

2 Year
Guarantee

LG33 CONFERENCE, MEETING & CAFÉ

The LG33 collection has been refined to add modern style, comfort and practicality to any interior. Beautiful design is complemented by utilising polypropylene to provide a lightweight yet strong model that will stand the test of time. These chairs surround users in their organic curves, adding to the feeling of comfort.

Plastic Seat Colours

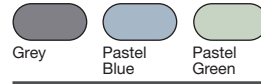

Grey

Pastel
Blue

Pastel
Green

Metal Frame Colours



Black

Wood Frame Colours



Beech



LG33A
Skid Frame

Price £306



LG33B
Wooden 4 Leg Frame

Price £363



From L/R Pastel Blue Plastic with Wooden 4 Leg Frame and Grey Plastic with Black Skid Frame

ALSEN

CONFERENCE, MEETING & CAFÉ



Why not make a statement, with this popular, multi-functional seating family?

- Selection of two-tone, perforated polymer shell finishes.
- Multiple frame options.
- Accompanying stools.

Metal Frame Colours



Chrome

Additional Information

Foot rest available in Chrome only.

All shells are white on inside face.

Wooden Frame Colours



Beech



Matte White



Graphite



Smoke (Ash)



Natural (Ash)

Plastic Colours



Orange



White



Nougat



Mustard



UJA1
Skid Frame

Price £454



UJA3
4 Legs

Price £421



UJA4
Skid Frame
650mm - Seat Height Stool
Price £555



UJA5
Skid Base
800mm - Seat Height Stool
Price £568



UJA6
Wood Frame

Price £486



UJA7
Wood Frame
650 - Seat Height Stool
Price £655



UJA8
Wood Frame
800mm - Seat Height Stool
Price £697

Conference, Meeting & Cafe Seating

2 Year
Guarantee

ALSEN CONFERENCE, MEETING & CAFÉ

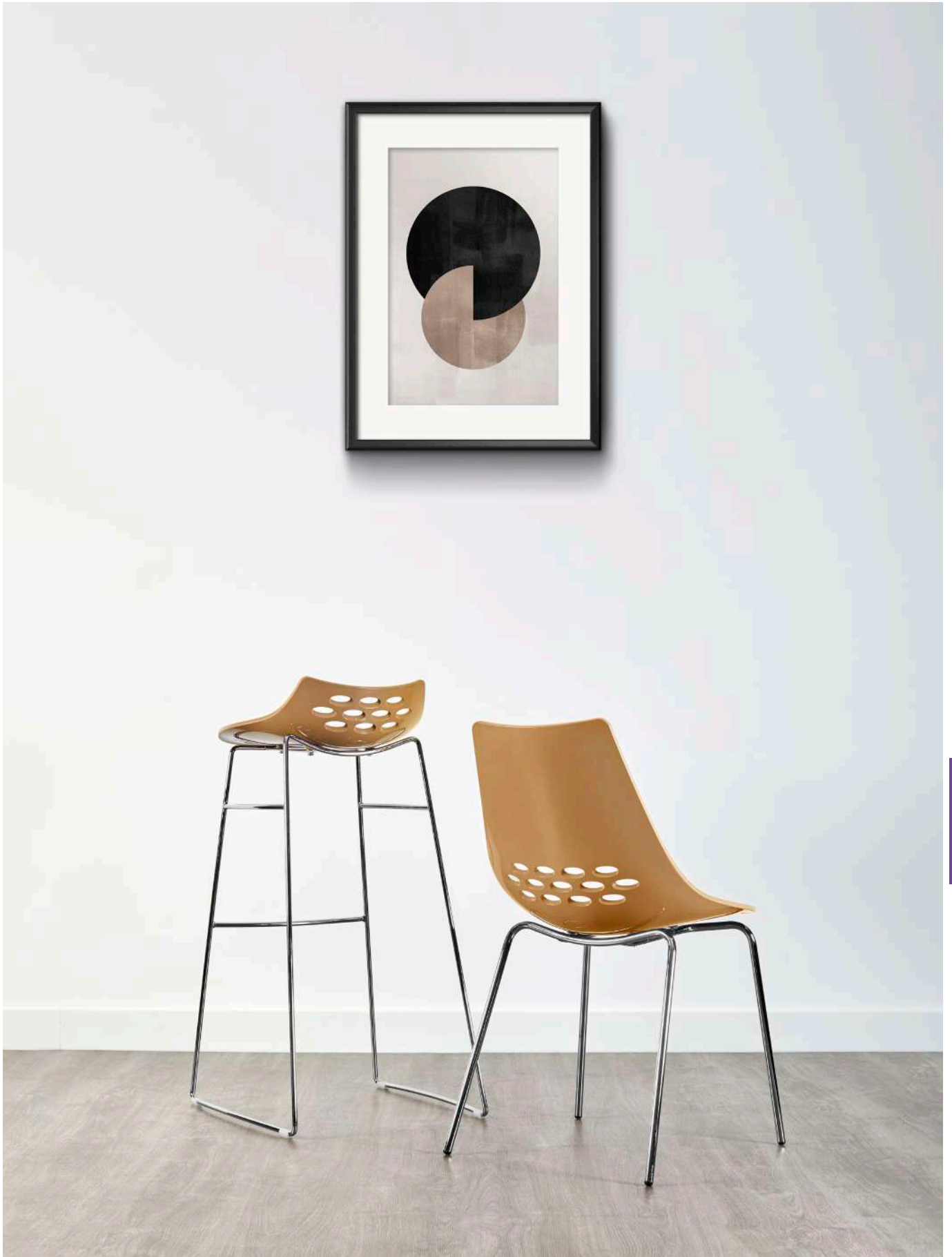

From L/R Black Plastic with Metal 4 Leg Frame and Nougat Plastic with Metal Frame

Conference,
Meeting &
Café Seating

GD2 STOOL

CONFERENCE, MEETING & CAFÉ



This retro-modern family of stools offers the perfect solution when wanting style with substance. The solid wood frames are offered in natural or stained options allowing them to be suited with their surroundings, whilst the seats can be specified in a show-wood or upholstered finishes. Available in low or high models to suit dining or poseur height tables.

Product Features



Wood Frame Colours

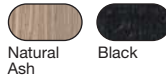

Additional Information

Upholstered Seat Cushion available in a variety of fabrics.



GD2A1

Show Wood Square High Stool

Price £631



GD2A2

Show Wood Square Low Stool

Price £568



GD2A5

Show Wood High Bench

Price £1,218



GD2A6

Show Wood Low Bench

Price £1,142



GD2B1

Square High Stool with Upholstered Seat

Band 1 £670
 Band 2 £688
 Band 3 £709
 Band 4 £729
 Band 5 £753
 Band 6 £774
 Band 7 £793



GD2B2

Square Low Stool with Upholstered Seat

Band 1 £610
 Band 2 £626
 Band 3 £648
 Band 4 £669
 Band 5 £693
 Band 6 £713
 Band 7 £733



GD2B5

High Bench with Upholstered Seat

Band 1 £1,298
 Band 2 £1,331
 Band 3 £1,385
 Band 4 £1,431
 Band 5 £1,484
 Band 6 £1,530
 Band 7 £1,578



GD2B6

Low Bench with Upholstered Seat

Band 1 £1,222
 Band 2 £1,255
 Band 3 £1,310
 Band 4 £1,357
 Band 5 £1,409
 Band 6 £1,455
 Band 7 £1,502

Conference, Meeting & Cafe Seating

5 Year
Guarantee

GD2 STOOL

CONFERENCE, MEETING & CAFÉ



Svensson Iconic 5553 (Band 5) with Natural Ash Frame

Conference,
Meeting &
Café Seating

GD3 STOOL

CONFERENCE, MEETING & CAFÉ



This stylishly simple family of stools offers visually light-weight models that are at home in break-out or modern working environments alike. Fully upholstered options can be specified in a selection of vibrant or muted toned fabrics to blend or accent colours around them. Available in low or high models to suit dining or poseur height tables.

Product Features



Metal Frame Colours

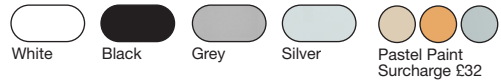

GD3B1
High Stool with
Upholstered Seat

Band 1	£376
Band 2	£389
Band 3	£408
Band 4	£429
Band 5	£449
Band 6	£465
Band 7	£487



GD3B2
Low Stool with
Upholstered Seat

Band 1	£321
Band 2	£335
Band 3	£356
Band 4	£376
Band 5	£395
Band 6	£412
Band 7	£433



GD3B3
Low Stool with
Upholstered Seat

Band 1	£343
Band 2	£357
Band 3	£366
Band 4	£389
Band 5	£406
Band 6	£424
Band 7	£438



From L/R Kvadrat Canvas 2 0684 (Band 4) and Kvadrat Canvas 2 0644 (Band 4) with White Frame

5 Year
Guarantee

LG27 CONFERENCE, MEETING & CAFÉ

This simply styled model with a fully upholstered finish brings both choice and a sense of fun to the workplace. With its light-weight construction and ability to stack vertically, the LG27 offers true agility when arranging your environment. Just add colour.

Product Features



Additional Information

Stackable up to 6 high. Available in a variety of fabrics.



LG27
Upholstered 460mm Seat
Height

Band 1	£476
Band 2	£503
Band 3	£536
Band 4	£569
Band 5	£606
Band 6	£637
Band 7	£668



Conference,
Meeting &
Café Seating

LG24 in Kvadrat Remix 2 412, 422, 452,163 (Band 4) and Steps in Kvadrat Remix 2 422, 452 (Band 4)

GC7 CONFERENCE, MEETING & CAFÉ



The GC7 range of chairs offers comfort and flexibility with a sleek profile ideally suited to today's modern office spaces. Our GC7 chairs are available in a four different coloured shells with integrated armrests and a gracefully curved backrest for optimal support. We make it easy to create a totally customised look for your workspace by offering eight interchangeable base options and a number of seat upholstery choices.

T. Optional Tilt Mechanism available.
(Suffix code with T. Example: GC7D2T)
Surcharge.....£44

Product Features



Plastic Colours



Frame Colours



GC7A1
4 Leg Base

Band 1	£330
Band 2	£337
Band 3	£347
Band 4	£358
Band 5	£369
Band 6	£379
Band 7	£388



GC7B1
Cantilever Base

Band 1	£449
Band 2	£456
Band 3	£468
Band 4	£476
Band 5	£489
Band 6	£498
Band 7	£507



GC7C1
Pyramid Base with Glides

Band 1	£509
Band 2	£518
Band 3	£530
Band 4	£537
Band 5	£550
Band 6	£560
Band 7	£568



GC7C2
Pyramid Base with Castors

Band 1	£511
Band 2	£520
Band 3	£532
Band 4	£539
Band 5	£552
Band 6	£563
Band 7	£572



From L/R Camira Blazer Magdalene CUZ21 (Band 4) and Camira Blazer Stanford CUZ2R (Band 4) with White Pyramid Base



GC7D1
4 Star Base with Glides

Band 1	£403
Band 2	£410
Band 3	£422
Band 4	£432
Band 5	£443
Band 6	£452
Band 7	£463

GC7D2
4 Star Base with Castors
T

Band 1	£413
Band 2	£421
Band 3	£432
Band 4	£442
Band 5	£452
Band 6	£463
Band 7	£472

GC7E1
5 Star Base with Glides

Band 1	£423
Band 2	£429
Band 3	£442
Band 4	£450
Band 5	£463
Band 6	£472
Band 7	£482

GC7E2
5 Star Base with Castors
T

Band 1	£435
Band 2	£443
Band 3	£453
Band 4	£464
Band 5	£474
Band 6	£485
Band 7	£494



From L/R Camira Blazer Silverdale CUZ1J (Band 4) and Camira Blazer Magdalene CUZ21 (Band 4) with Black 5 Star Base on Castors

GC5 CONFERENCE, MEETING & CAFÉ



The GC5 chair is transitional chair that supports agile learning environments where teaching and training modes are fluid and traditional chairs and desks just won't do. They are designed to combine mobile seating with personal storage whilst providing a robust surface which can be utilised for paperwork tasks, when using portable electronic devices or when moving from collaborative to individual working scenarios.

Product Features



Plastic Shell Colours



Additional Information

Wheel base available in Grey only. Upholstered Seat Pad available in a variety of fabrics.



GC5B1
Mobile Chair with Storage with Writing Tablet Plastic Shell

Price £510



GC5B2
Mobile Chair with Storage with Writing Tablet Upholstered Seat Pad

Band 1	£572
Band 2	£592
Band 3	£616
Band 4	£639
Band 5	£667
Band 6	£691
Band 7	£714



From L/R Sky Blue and Yellow Plastic

5 Year Guarantee

CONFERENCE, MEETING & CAFÉ

HR

The ultimate blend of style and comfort, Hour is a mix of wood and steel that provides the perfect statement. Seat and back shells are produced in profiled laminated plywood that have a lacquer finish for wipe-down durability. Upholstery fabrics for seat panels are available in a wide selection of patterns, colours & weaves, suitable for contract use in public areas.

Product Features



Wood Colours



Frame Colours



Additional Information

Available with an upholstered seat in a range of fabrics. Complimentary to Moment Tables.

Upholstery kit

Band 1	£57	Band 5	£100
Band 2	£63	Band 6	£110
Band 3	£75	Band 7	£121
Band 4	£88		



HR1W
Walnut 4 Leg

Price £471



HR1N
Natural 4 Leg

Price £471



HR1SW
Walnut 4 Leg
725mm Seat Height

Price £615



HR1SN
Natural 4 Leg
725mm Seat Height

Price £615



Walnut 4 Leg

Conference,
Meeting &
Café Seating

LG31

CONFERENCE, MEETING & CAFÉ



LG31 is a family of single-piece laminated shell chairs and stools in a choice of classic styles.

- Available with or without upholstered seat pads.
- Stool options available.
- Perfect for cafés, bistros, restaurants.

Product Features



Metal Frame Colours



Black

Wood Colours



Black



Ash

Additional Information

Upholstered seat pads available in a variety of fabrics.



LG31D
4 Leg Frame

Price £238



LG31C
Sled Frame

Price £238



LG31LS
Sled Frame
650mm Seat Height

Price £347



LG31HS
Sled Frame
750mm Seat Height

Price £361



From L/R Lacquered Ash and Black



LG31US
4 Leg Frame
with Upholstered Seat

Band 1	£293
Band 2	£307
Band 3	£322
Band 4	£335
Band 5	£350
Band 6	£363
Band 7	£377



LG31CUS
Sled Frame
with Upholstered Seat

Band 1	£293
Band 2	£307
Band 3	£322
Band 4	£335
Band 5	£350
Band 6	£363
Band 7	£377



LG31LSUS
Sled Frame
with Upholstered Seat
650mm Seat Height

Band 1	£403
Band 2	£417
Band 3	£432
Band 4	£445
Band 5	£458
Band 6	£473
Band 7	£488



LG31HSUS
Sled Frame
with Upholstered Seat
750mm Seat Height

Band 1	£416
Band 2	£429
Band 3	£444
Band 4	£457
Band 5	£472
Band 6	£486
Band 7	£500



From L/R Lacquered Ash with Camira Blazer Eynesbury CUZ2W (Band 4) Seat and Black with Camira Blazer Woodcroft CUZ2Z (Band 4) Seat

CAFÉ & BISTRO

CONFERENCE, MEETING & CAFÉ

5 Year
Guarantee

Café & Bistro is a family of single-piece laminated shell chairs combined with a heavy-duty steel frame. Available in a choice of classic styles that are a unification of elegance with robust durability. Perfect for cafés, bistros and restaurants.

Product Features



Metal Frame Colours



Chrome

Wood Colours



Natural



Natural
Satin



American
Walnut

Additional Information

Chairs stackable where stated. Stackable up to 5 units high. Upholstered seat available in a variety of fabrics. Not stackable in vinyl/leather.



From L/R American Walnut and Natural



EG04N
4 Leg Natural Satin

Price£165



EG04W
4 Leg American Walnut

Price£192



EG05N
4 Leg Natural Satin with Fully Welded Frame

Price£211



EG05W
4 Leg American Walnut with Fully Welded Frame

Price£235



EG04NSP
4 Leg Upholstered Seat Natural Satin

Band 1£218
Band 2£226
Band 3£245
Band 4£259
Band 5£273
Band 6£286
Band 7£302



EG04WSP
4 Leg Upholstered Seat American Walnut

Band 1£244
Band 2£251
Band 3£266
Band 4£280
Band 5£299
Band 6£311
Band 7£326



EG05NSP
4 Leg Upholstered Seat Natural Satin with Fully Welded Frame

Band 1£261
Band 2£270
Band 3£286
Band 4£302
Band 5£316
Band 6£330
Band 7£345



EG05WSP
4 Leg Upholstered Seat American Walnut with Fully Welded Frame

Band 1£285
Band 2£294
Band 3£311
Band 4£326
Band 5£340
Band 6£356
Band 7£369



TVR1
4 Leg Natural Finish (Stackable)

Price£155



TC34N
4 Leg Natural Finish (Stackable)

Price£168



TC4D
4 Leg Natural Finish (Stackable)

Price£155



TVR1SP
4 Leg Upholstered Seat Natural Finish (Stackable)

Band 1£205
Band 2£217
Band 3£230
Band 4£247
Band 5£261
Band 6£275
Band 7£290



TC34NSP
4 Leg Upholstered Seat Natural Finish (Stackable)

Band 1£225
Band 2£235
Band 3£251
Band 4£265
Band 5£279
Band 6£294
Band 7£309



TC4DSP
4 Leg Upholstered Seat Natural Finish (Stackable)

Band 1£205
Band 2£217
Band 3£230
Band 4£247
Band 5£261
Band 6£275
Band 7£290

VISA

CONFERENCE, MEETING & CAFÉ



A modern take on a classic design; Visa with its choice of vibrant colours or natural beech finish makes a statement.

- At home in domestic or contract surroundings.
- Optional seat pad.
- Swivel base option.

Product Features



Plastic Colours

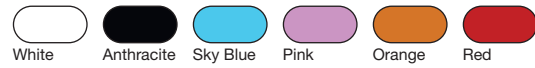

Frame Colours



Wood Colours



Optional Extras

MCT	Trolley (for 4 leg versions only)	£363
-----	-----------------------------------	------



VIS1
4 Leg Plastic (Stackable)
£200



VISA
4 Leg Plastic with Arms
(Stackable)
£211



VIS1V
4 Leg Natural Wood
(Stackable)
£259



VIS1SP
4 Leg Upholstered Seat Pad
(Stackable)

Band 1	£259
Band 2	£265
Band 3	£278
Band 4	£291
Band 5	£304
Band 6	£316
Band 7	£327
Leather Group 1	POA



VISASP
4 Leg Upholstered Seat Pad
with Arms (Stackable)

Band 1	£269
Band 2	£277
Band 3	£290
Band 4	£304
Band 5	£314
Band 6	£327
Band 7	£337
Leather Group 1	POA



VISASSP
Swivel Chair Upholstered Seat
Pad with Arms

Band 1	£361
Band 2	£367
Band 3	£382
Band 4	£393
Band 5	£406
Band 6	£419
Band 7	£428
Leather Group 1	POA



VISAS
Swivel Chair with Arms
£302

Conference,
Meeting &
Café Seating

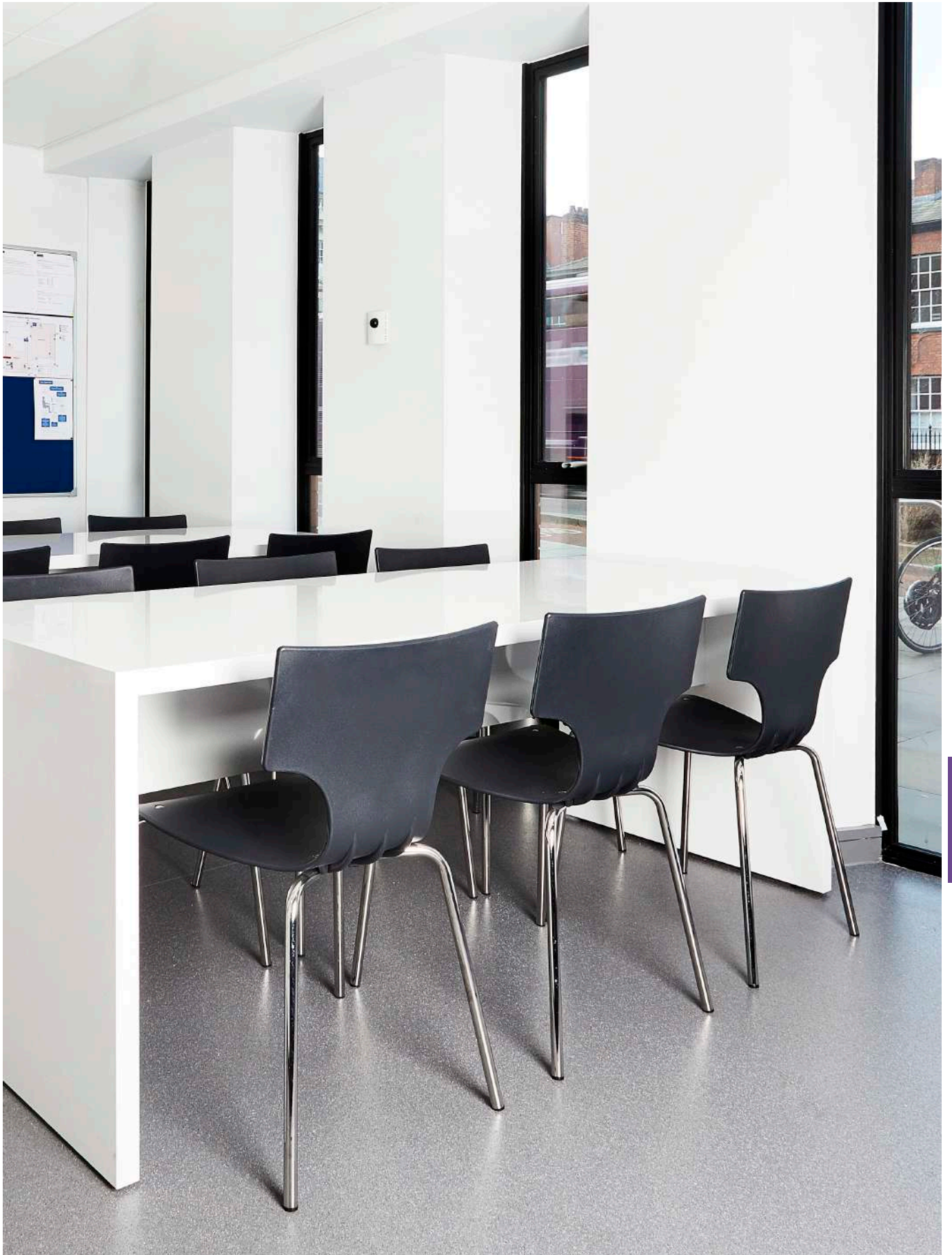

Black Plastic with Chrome 4 Leg

GARO

CONFERENCE, MEETING & CAFÉ

5 Year Guarantee

Garó is a pure and simple chair, created using quality polypropylene to make it not only lightweight and robust, but suitable for a number of diverse environments. The stackable smart design lends itself to everything from contemporary dining, to casual outdoor use.

Product Features



Plastic Seat Colours



Additional Information

Stackable up to 4 chairs high. All outdoor products can fade or stain when left out in extreme weather conditions.



KARG1
4 Leg

Price £213



From L/R Nougat Plastic and White Plastic

Conference,
Meeting &
Café Seating

2 Year
Guarantee

BL6 CONFERENCE, MEETING & CAFÉ

BL6 is a polypropylene stackable chair perfect for indoor and outdoor use. The sturdy, easy to clean design is ideal for a modern environment, cafeteria or bar, while the hole in the seat facilitates water drainage.

Product Features



Plastic Seat Colours



Additional Information

Stackable up to 6 chairs high. All outdoor products can fade or stain when left out in extreme weather conditions.



BL6
4 Leg

Price £218



Grey Plastic

A51 CONFERENCE, MEETING & CAFÉ



Bright, light and right! Whether used indoor or outdoor, these quality moulded polypropylene chairs put the 'fun' into 'funky'. These lightweight chairs are extremely robust, while the hole in the seat facilitates water drainage. The attractive design and curved backrest make it suited to a modern environment: home, terrace or cafe.

Product Features



Plastic Seat Colours



Additional Information

Stackable up to 6 chairs high. Durable wipe-down surface. All outdoor products can fade or stain when left out in extreme weather conditions.



A51
4 Leg

Price £265



Green, Red, Orange and White Plastic

Conference,
Meeting &
Cafe Seating



ONIO

SOFT SEATING, RECEPTION & BREAKOUT

Onio's balanced pose is curved for comfort, a slender sloping back rest partnered with foam seat, make for a reassuring figure. An overall compact design provides ample scope for application, be that in lounge or waiting areas or breakout and meeting spaces.

Product Features



Please Note

Available in selected fabrics only - Please contact our Sales Department for further information.



ONIOU1
Upholstered Tub Chair

Band 1	£976
Band 2	£1,055
Band 3	£1,165
Band 4	£1,266
Band 5	£1,380
Band 6	£1,479
Band 7	£1,580



Backrest Camira Blazer Dartmouth CUZ2Q Seat Camira Yoredale Simonstone UDA05

BRETEN

CONFERENCE, MEETING & CAFÉ

5 Year
Guarantee

This on-trend collection is perfect for those who want comfortable seating and a modern twist. Being lightweight and durable means Bretten can be easily moved, perfect for office or dining spaces, and is suitable for indoor and covered outdoor areas.

Metal Colours



Grey

Additional Information

All outdoor products can fade or stain when left out in extreme weather conditions.



BRE1
Distressed 4 Leg

Price £297



BREHS
Distressed 4 Leg
760mm Seat Height

Price £361





MEROUX CONFERENCE, MEETING & CAFÉ

The Meroux collection is carefully crafted from sheet metal with a distressed look finish. Strong, durable, lightweight and stackable means Meroux is a favourite of cafés, dining areas and retro spaces. Suitable for indoor and covered outdoor areas.

Paint Colours (£37 surcharge)



Metal Colours



Additional Information

Stackable up to four high. Surcharge for coloured paint finish with a minimum order quantity - 10 of the same item in the same colour finish. All outdoor products can fade or stain when left out in extreme weather conditions.



MER1
4 Leg

Price £244



MERLS
4 Leg
455mm Seat Height

Price £188



MERHS
4 Leg
745mm Seat Height

Price £226



Conference,
Meeting &
Café Seating

VONA

CONFERENCE, MEETING & CAFÉ



In keeping with our social responsibility, we introduce this sustainable chair design; a simple but unique chair made of recycled Felt (60% recycled PP bottles and 40% non-woven textile).

Vona is a conference chair that can be stored into vertical stacks. The seat consists of ergonomic triangular plates allowing comfortable sitting by adapting to the body.

Product Features



Seat Colours



Grey

Frame Colours



Black

Additional Information

Stackable up to 3 chairs high. Seat pad only available in Gabriel Fame.



LS34A
Sled Frame

Gabriel Fame £597
(Seat pad only)

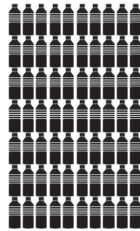

Gabriel Fame 68146 (Band 4) Seat Pad

5 Year Guarantee

NOTE CONFERENCE, MEETING & CAFÉ

This unique chair collection can be used across a plethora of interior environments.

- Contemporary shape lends itself to meeting rooms, conference areas and dining spaces.
- Available in four different solid plastic colours.
- Option of an upholstered seat pad.

Plastic Colours

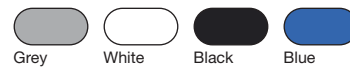

Frame Colours



Product Features



Optional Extras

FULNK	Retractable link set	£24
MCT	Trolley	£363



FUS1
Plastic Seat and Back
(Stackable)
£198



FUS1SP
Upholstered Seat
(Stackable)

Band 1	£251
Band 2	£262
Band 3	£279
Band 4	£300
Band 5	£314
Band 6	£331
Band 7	£347
Leather Group 1	POA



Blue Plastic

Conference,
Meeting &
Café Seating

THEIA

CONFERENCE, MEETING & CAFÉ



The Theia Chair is available with or without arms in a range of plastic colours and multiple finish variants also with the option of left or right handed writing tablets.

Plastic Colours



Frame Colours



Product Features



Optional Extras

ETROL	Trolley	£861
EBASK	Storage Basket	£138



EBASK Storage Basket



White Plastic with Camira Blazer Scottsdale CUZ3E (Band 4) Seat and Back with Chrome Frame



E11
Plastic Seat & Back
(Stackable: Floor 20/Trolley 40)
£217



EIA
Plastic Seat & Back with Arms
(Stackable: Floor 20/Trolley 40)
£285



EIART
Plastic Seat & Back with Arms
& Writing Tablet (Right Hand)
(Stackable: Floor 20/Trolley 40)
(Remove Tablet to Stack)
£408



EIALT
Plastic Seat & Back with Arms
& Writing Tablet (Left Hand)
(Stackable: Floor 20/Trolley 40)
(Remove Tablet to Stack)
£408



E11SP
Upholstered Seat
(Stackable: Floor 15/Trolley 15)

Band 1	£286
Band 2	£297
Band 3	£311
Band 4	£326
Band 5	£340
Band 6	£355
Band 7	£367
Leather Group 1	POA



EIASP
Upholstered Seat with Arms
(Stackable: Floor 15/Trolley 15)

Band 1	£345
Band 2	£355
Band 3	£369
Band 4	£385
Band 5	£396
Band 6	£411
Band 7	£425
Leather Group 1	POA



EIARTSP
Upholstered Seat with Arms &
Writing Tablet (Right Hand)
(Stackable: Floor 15/Trolley 15)
(Remove Tablet to Stack)

Band 1	£469
Band 2	£477
Band 3	£494
Band 4	£508
Band 5	£522
Band 6	£536
Band 7	£551
Leather Group 1	POA



EIALTSP
Upholstered Seat with Arms &
Writing Tablet (Left Hand)
(Stackable: Floor 15/Trolley 15)
(Remove Tablet to Stack)

Band 1	£469
Band 2	£477
Band 3	£494
Band 4	£508
Band 5	£522
Band 6	£536
Band 7	£551
Leather Group 1	POA



E11BP
Upholstered Seat & Back
(Stackable: Floor 15/Trolley 15)

Band 1	£332
Band 2	£342
Band 3	£360
Band 4	£371
Band 5	£387
Band 6	£401
Band 7	£415
Leather Group 1	POA



EIABP
Upholstered Seat & Back
with Arms
(Stackable: Floor 15/Trolley 15)

Band 1	£392
Band 2	£401
Band 3	£417
Band 4	£429
Band 5	£445
Band 6	£458
Band 7	£473
Leather Group 1	POA



EIARTBP
Upholstered Seat & Back with
Arms & Writing Tablet
(Right Hand)
(Stackable: Floor 15/Trolley 15)
(Remove Tablet to Stack)

Band 1	£517
Band 2	£526
Band 3	£539
Band 4	£554
Band 5	£569
Band 6	£583
Band 7	£598
Leather Group 1	POA



EIALTBP
Upholstered Seat & Back with
Arms & Writing Tablet
(Left Hand)
(Stackable: Floor 15/Trolley 15)
(Remove Tablet to Stack)

Band 1	£517
Band 2	£526
Band 3	£539
Band 4	£554
Band 5	£569
Band 6	£583
Band 7	£598
Leather Group 1	POA

THEIA STOOL

CONFERENCE, MEETING & CAFÉ



The Theia Stool is available in 2 different height options. A range of plastic colours and multiple finish variants are provided with or without arms.

Plastic Colours



Frame Colours



Product Features



Vescom Bowen 7030.37 (Band 6) with Chrome Frame



THEIA STOOL

CONFERENCE, MEETING & CAFÉ



EIH
High Stool
Plastic Seat & Back
(Stackable: Floor 20)
£332



EIAH
High Stool
Plastic Seat and Back with Arms
(Stackable: Floor 20)
£385



EIL
Low Stool
Plastic Seat and Back with Arms
(Stackable: Floor 20)
£332



EIAL
Low Stool
Plastic Seat and Back with Arms
(Stackable: Floor 20)
£385



EIHSP
High Stool
Upholstered Seat
(Stackable: Floor 15)

Band 1	£388
Band 2	£396
Band 3	£413
Band 4	£427
Band 5	£442
Band 6	£456
Band 7	£469
Leather Group 1	POA



EIAHSP
High Stool
Upholstered Seat with Arms
(Stackable: Floor 15)

Band 1	£437
Band 2	£448
Band 3	£464
Band 4	£476
Band 5	£491
Band 6	£506
Band 7	£519
Leather Group 1	POA



EILSP
Low Stool
Upholstered Seat
(Stackable: Floor 15)

Band 1	£388
Band 2	£396
Band 3	£413
Band 4	£427
Band 5	£442
Band 6	£456
Band 7	£469
Leather Group 1	POA



EIALSP
Low Stool
Upholstered Seat with Arms
(Stackable: Floor 15)

Band 1	£437
Band 2	£448
Band 3	£464
Band 4	£476
Band 5	£491
Band 6	£506
Band 7	£519
Leather Group 1	POA



EIHBP
High Stool
Upholstered Seat & Back
(Stackable: Floor 15)

Band 1	£450
Band 2	£461
Band 3	£475
Band 4	£490
Band 5	£505
Band 6	£518
Band 7	£533
Leather Group 1	POA



EIAHBP
High Stool
Upholstered Seat & Back
with Arms
(Stackable: Floor 15)

Band 1	£492
Band 2	£504
Band 3	£518
Band 4	£533
Band 5	£546
Band 6	£560
Band 7	£575
Leather Group 1	POA



EILBP
Low Stool
Upholstered Seat & Back
(Stackable: Floor 15)

Band 1	£450
Band 2	£461
Band 3	£475
Band 4	£490
Band 5	£505
Band 6	£518
Band 7	£533
Leather Group 1	POA



EIALBP
Low Stool
Upholstered Seat & Back
with Arms
(Stackable: Floor 15)

Band 1	£492
Band 2	£504
Band 3	£518
Band 4	£533
Band 5	£546
Band 6	£560
Band 7	£575
Leather Group 1	POA

OLI

CONFERENCE, MEETING & CAFÉ



Oli is a stylish yet robust stacking chair which is available in seven vibrant colours.

- 3 main versions.
- Perforated back that moulds to the individual.
- Available with or without arms.

Plastic Colours

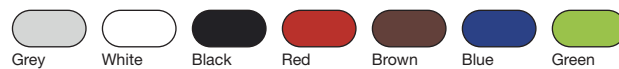

Frame Colours



Chrome

Product Features



Optional Extras

OLICT Trolley

£304



Red Plastic with Camira Xtreme Sombrero YS046 (Band 1) Seat and Back



OLI4
4 Leg Plastic Seat and Back (Stackable)
£170



OLA4
4 Leg with Arms and Plastic Seat and Back (Stackable)
£221



OLC
Skid Frame with Plastic Seat and Back (Stackable)
£179



OLS
4 Leg Stool with Plastic Seat and Back
£244



OL4SP
4 Leg Upholstered Seat (Stackable)

Band 1	£231
Band 2	£245
Band 3	£261
Band 4	£278
Band 5	£294
Band 6	£311
Band 7	£327
Leather Group 1	POA



OLA4SP
4 Leg with Arms Upholstered Seat (Stackable)

Band 1	£285
Band 2	£297
Band 3	£312
Band 4	£330
Band 5	£346
Band 6	£363
Band 7	£377
Leather Group 1	POA



OLCSP
Skid Frame with Upholstered Seat (Stackable)

Band 1	£244
Band 2	£254
Band 3	£270
Band 4	£289
Band 5	£304
Band 6	£322
Band 7	£335
Leather Group 1	POA



OLSSP
4 Leg Stool with Upholstered Seat

Band 1	£305
Band 2	£316
Band 3	£332
Band 4	£352
Band 5	£365
Band 6	£385
Band 7	£400
Leather Group 1	POA



OL4SBP
4 Leg with Upholstered Seat and Back (Stackable)

Band 1	£273
Band 2	£284
Band 3	£301
Band 4	£318
Band 5	£332
Band 6	£352
Band 7	£365
Leather Group 1	POA



OLA4SBP
4 Leg with Arms Upholstered Seat and Back (Stackable)

Band 1	£324
Band 2	£333
Band 3	£353
Band 4	£369
Band 5	£386
Band 6	£402
Band 7	£419
Leather Group 1	POA



OLCSBP
Skid Frame with Upholstered Seat and Back (Stackable)

Band 1	£280
Band 2	£293
Band 3	£309
Band 4	£327
Band 5	£342
Band 6	£361
Band 7	£373
Leather Group 1	POA



OLSSBP
4 Leg Stool with Upholstered Seat and Back

Band 1	£345
Band 2	£356
Band 3	£371
Band 4	£389
Band 5	£406
Band 6	£423
Band 7	£437
Leather Group 1	POA

SJX FULLY UPHOLSTERED CONFERENCE, MEETING & CAFÉ

5 Year
Guarantee

SJX is the perfect seating solution for a variety of applications, with three different leg frame options.

- Four leg, cantilever and mobile on castors.
- Available with or without arms and has an optional writing tablet.
- The fully upholstered version can be finished in almost any fabric of your choice, making it a versatile product for your interiors scheme.

Frame Colours

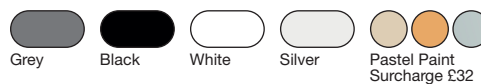

Product Features



Optional Extras

SJXLNK Retractable link set	£25
MCT Trolley (for 4 leg versions only)	£363

Additional Information

*Tablet version stacking is limited.



Camira Xtreme Sombrero YS046 (Band 1) with 4 Leg Castor and Cantilever Grey Frame

5 Year
Guarantee

SJX FULLY UPHOLSTERED CONFERENCE, MEETING & CAFÉ



SJX1
4 Leg (Stackable)

Band 1	£225
Band 2	£238
Band 3	£255
Band 4	£273
Band 5	£289
Band 6	£306
Band 7	£323
Leather Group 1	POA



SJXA
4 Leg with Arms (Stackable)

Band 1	£266
Band 2	£278
Band 3	£299
Band 4	£314
Band 5	£330
Band 6	£347
Band 7	£364
Leather Group 1	POA



**SJXRT (R/H)
SJXLT (L/H)**
4 Leg with Writing Tablet and
Arms (Stackable)*

Band 1	£367
Band 2	£377
Band 3	£395
Band 4	£415
Band 5	£429
Band 6	£448
Band 7	£465
Leather Group 1	POA



SJX1W
4 Leg with Castors

Band 1	£275
Band 2	£286
Band 3	£305
Band 4	£323
Band 5	£337
Band 6	£358
Band 7	£371
Leather Group 1	POA



SJXAW
4 Leg with Castors and Arms

Band 1	£318
Band 2	£328
Band 3	£346
Band 4	£364
Band 5	£382
Band 6	£396
Band 7	£415
Leather Group 1	POA



**SJXRTW (R/H)
SJXLTW (L/H)**
4 Leg with Castors, Writing
Tablet & Arms

Band 1	£419
Band 2	£428
Band 3	£446
Band 4	£465
Band 5	£478
Band 6	£498
Band 7	£515
Leather Group 1	POA



SJX1SW
Swivel Base

Band 1	£393
Band 2	£403
Band 3	£423
Band 4	£442
Band 5	£456
Band 6	£474
Band 7	£490
Leather Group 1	POA



SJXC
Cantilever
(Stackable)

Band 1	£266
Band 2	£278
Band 3	£299
Band 4	£314
Band 5	£330
Band 6	£347
Band 7	£364
Leather Group 1	POA



SJXCA
Cantilever with Arms
(Stackable)

Band 1	£309
Band 2	£322
Band 3	£337
Band 4	£358
Band 5	£371
Band 6	£389
Band 7	£407
Leather Group 1	POA



**SJXCRT (R/H)
SJXCLT (L/H)**
Cantilever Chair with Writing
Tablet & Arms (Stackable)*

Band 1	£410
Band 2	£422
Band 3	£437
Band 4	£456
Band 5	£473
Band 6	£490
Band 7	£506
Leather Group 1	POA



SJXASW
Swivel Base with Arms

Band 1	£434
Band 2	£446
Band 3	£465
Band 4	£482
Band 5	£498
Band 6	£517
Band 7	£533
Leather Group 1	POA

Conference,
Meeting &
Café Seating

SJX UPHOLSTERED SEAT CONFERENCE, MEETING & CAFÉ

5 Year
Guarantee

SJX is the perfect seating solution for a variety of applications, with three different leg frame options.

- Four leg, cantilever and mobile on castors.
- Available with or without arms and has an optional writing tablet.
- The upholstered seat version can be finished in almost any fabric of your choice, making it a versatile product for your interiors scheme.

Back Plastic Colours

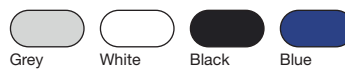

Frame Colours



Product Features



Additional Information

*Tablet version stacking is limited.

Optional Extras

SJXLNK	Retractable link set	£25
MCT	Trolley (for 4 leg versions only)	£363



Camira Xtreme Steel YS095 (Band 1) with Black Plastic and 4 Leg White Frame

SJX UPHOLSTERED SEAT CONFERENCE, MEETING & CAFÉ



SJX1SP
4 Leg
(Stackable)

Band 1	£225
Band 2	£238
Band 3	£255
Band 4	£273
Band 5	£289
Band 6	£306
Band 7	£323
Leather Group 1	POA



SJXASP
4 Leg with Arms (Stackable)

Band 1	£266
Band 2	£278
Band 3	£297
Band 4	£314
Band 5	£330
Band 6	£347
Band 7	£364
Leather Group 1	POA



SJXRTSP (R/H)
SJXLTSP (L/H)
4 Leg with Writing Tablet and
Arms (Stackable)*

Band 1	£367
Band 2	£377
Band 3	£395
Band 4	£415
Band 5	£429
Band 6	£448
Band 7	£465
Leather Group 1	POA



SJX1SPW
4 Leg with Castors

Band 1	£275
Band 2	£286
Band 3	£305
Band 4	£323
Band 5	£337
Band 6	£358
Band 7	£371
Leather Group 1	POA



SJXASPW
4 Leg with Castors and Arms

Band 1	£318
Band 2	£328
Band 3	£346
Band 4	£364
Band 5	£382
Band 6	£396
Band 7	£415
Leather Group 1	POA



SJXRTSPW (R/H)
SJXLTSPW (L/H)
4 Leg with Castors, Writing
Tablet and Arms

Band 1	£419
Band 2	£428
Band 3	£446
Band 4	£465
Band 5	£478
Band 6	£498
Band 7	£515
Leather Group 1	POA



SJX1SPSW
Swivel Base

Band 1	£393
Band 2	£403
Band 3	£423
Band 4	£442
Band 5	£456
Band 6	£474
Band 7	£490
Leather Group 1	POA



SJXCSP
Cantilever
(Stackable)

Band 1	£266
Band 2	£278
Band 3	£299
Band 4	£314
Band 5	£330
Band 6	£347
Band 7	£364
Leather Group 1	POA



SJXCASP
Cantilever with Arms
(Stackable)

Band 1	£309
Band 2	£322
Band 3	£337
Band 4	£358
Band 5	£371
Band 6	£389
Band 7	£407
Leather Group 1	POA



SJXCRTSP (R/H)
SJXCLTSP (L/H)
Cantilever with Writing Tablet
& Arms (Stackable)*

Band 1	£410
Band 2	£422
Band 3	£437
Band 4	£456
Band 5	£473
Band 6	£490
Band 7	£506
Leather Group 1	POA



SJXASPSW
Swivel Base with Arms

Band 1	£434
Band 2	£446
Band 3	£465
Band 4	£482
Band 5	£498
Band 6	£517
Band 7	£533
Leather Group 1	POA

SJX MESH

CONFERENCE, MEETING & CAFÉ



SJX is the perfect seating solution for a variety of applications, with three different leg frame options.

- Four leg, cantilever and mobile on castors.
- Available with or without arms and has an optional writing tablet.

Frame Colours

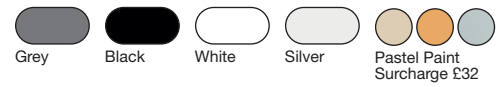

Product Features



Additional Information

*Tablet version stacking is limited.

Optional Extras

SJXLNK	Retractable link set	£25
MCT	Trolley (for 4 leg versions only)	£363



Conference, Meeting & Cafe Seating

Camira Blazer Knightsbridge CUZ26 (Band 4) with 4 Leg Black Frame

SJX MESH CONFERENCE, MEETING & CAFÉ



SJXM1
4 Leg Upholstered Seat
(Stackable)

Band 1	£225
Band 2	£238
Band 3	£255
Band 4	£273
Band 5	£289
Band 6	£306
Band 7	£323
Leather Group 1	POA



SJXMA
4 Leg Upholstered Seat with
Arms (Stackable)

Band 1	£266
Band 2	£278
Band 3	£299
Band 4	£314
Band 5	£330
Band 6	£347
Band 7	£364
Leather Group 1	POA



**SJXMRT (R/H)
SJXMLT (L/H)**
4 Leg Upholstered Seat with
Writing Tablet and Arms
(Stackable)*

Band 1	£367
Band 2	£377
Band 3	£395
Band 4	£415
Band 5	£429
Band 6	£448
Band 7	£465
Leather Group 1	POA



SJXM1W
4 Leg Upholstered Seat with
Castors

Band 1	£275
Band 2	£286
Band 3	£305
Band 4	£323
Band 5	£337
Band 6	£358
Band 7	£371
Leather Group 1	POA



SJXMAW
4 Leg Upholstered Seat with
Castors and Arms

Band 1	£318
Band 2	£328
Band 3	£346
Band 4	£364
Band 5	£382
Band 6	£396
Band 7	£415
Leather Group 1	POA



**SJXMRTW (R/H)
SJXMLTW (L/H)**
4 Leg Upholstered Seat with
Writing Tablet - Castors and
Arms

Band 1	£419
Band 2	£428
Band 3	£445
Band 4	£465
Band 5	£478
Band 6	£498
Band 7	£515
Leather Group 1	POA



SJXM1SW
Swivel Base

Band 1	£393
Band 2	£403
Band 3	£423
Band 4	£438
Band 5	£456
Band 6	£474
Band 7	£490
Leather Group 1	POA



SJXMC
Cantilever Upholstered Seat
(Stackable)

Band 1	£266
Band 2	£278
Band 3	£299
Band 4	£314
Band 5	£330
Band 6	£347
Band 7	£364
Leather Group 1	POA



SJXMCA
Cantilever Upholstered Seat
with Arms (Stackable)

Band 1	£309
Band 2	£322
Band 3	£337
Band 4	£358
Band 5	£371
Band 6	£389
Band 7	£407
Leather Group 1	POA



**SJXMCR (R/H)
SJXMCLT (L/H)**
Cantilever Upholstered Seat
with Writing Tablet and Arms
(Stackable)*

Band 1	£410
Band 2	£422
Band 3	£437
Band 4	£456
Band 5	£473
Band 6	£490
Band 7	£506
Leather Group 1	POA



SJXMASW
Swivel Base with Arms

Band 1	£434
Band 2	£446
Band 3	£465
Band 4	£482
Band 5	£498
Band 6	£517
Band 7	£533
Leather Group 1	POA

SJX PLASTIC

CONFERENCE, MEETING & CAFÉ

5 Year Guarantee

SJX is the perfect seating solution for a variety of applications, with three different leg frame options.

- Four leg, cantilever and mobile on castors.
- Available with or without arms and has an optional writing tablet.

Plastic Colours



Frame Colours



Product Features



Additional Information

*Tablet version stacking is limited.

Optional Extras

SJXLNK Retractable link set	£25
MCT Trolley (for 4 leg versions only)	£363



SJXP1
4 Leg (Stackable)
£192



SJXPA
4 Leg with Arms
(Stackable)
£231



SJXPRT (R/H)
SJXPLT (L/H)
4 Leg with Writing Tablet & Arms
(Stackable)*
£318



SJXP1W
4 Leg with Castors
£244



SJXPAW
4 Leg with Castors and Arms
£284



SJXPRTW (R/H)
SJXPLTW (L/H)
4 Leg Chair with Castors
Writing Tablet & Arms
£367



SJXP1SW
Swivel Base
£386



SJXCP1
Cantilever
(Stackable)
£260



SJXCPA
Cantilever with Arms
(Stackable)
£302



SJXCPR (R/H)
SJXCPLT (L/H)
Cantilever with Writing Tablet &
Arms (Stackable)*
£387



SJXPASW
Swivel Base with Arms
£427

5 Year
Guarantee

SJX PLASTIC CONFERENCE, MEETING & CAFÉ



White Plastic with White Cantilever Frame

Conference,
Meeting &
Café Seating

ZELA FULLY UPHOLSTERED CONFERENCE, MEETING & CAFÉ



Plastic Colours



Matching Plastic Underpan (Seat)

Frame Colours



Product Features



Additional Information

Swivel Versions - Available with chrome frame only.
*Tablet version stacking is limited.

Optional Extras

Polished aluminum arm £48 surcharge
ZTROL Trolley (for 4 leg versions only)
Will stack up to 18 high

£561



Stacking aid

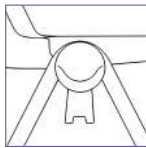

Dual link and stacking feature

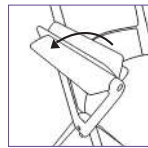

Width adjustable arm



Kvadrat Canvas 2 0954 (Band 4) with White Plastic and White Frame

5 Year
Guarantee

ZELA FULLY UPHOLSTERED CONFERENCE, MEETING & CAFÉ



ZL1BP
4 Leg (Stackable)

Band 1	£155
Band 2	£162
Band 3	£178
Band 4	£193
Band 5	£209
Band 6	£221
Band 7	£238
Leather Group 1	POA



ZLABP
4 Leg with Black Plastic Arms
(Stackable)

Band 1	£193
Band 2	£203
Band 3	£219
Band 4	£231
Band 5	£249
Band 6	£262
Band 7	£277
Leather Group 1	POA



**ZLARTBP (RH)
ZLALTBP (LH)**
4 Leg with Black Aluminium Arms and
Writing Tablet (Stackable)*

Band 1	£306
Band 2	£316
Band 3	£331
Band 4	£346
Band 5	£362
Band 6	£373
Band 7	£389
Leather Group 1	POA



ZL1BPSW
Swivel Base

Band 1	£337
Band 2	£347
Band 3	£364
Band 4	£377
Band 5	£393
Band 6	£408
Band 7	£423
Leather Group 1	POA



ZLABPSW
Swivel Base with Black Plastic Arms

Band 1	£377
Band 2	£388
Band 3	£406
Band 4	£421
Band 5	£433
Band 6	£448
Band 7	£464
Leather Group 1	POA



Conference,
Meeting &
Café Seating

ZELA UPHOLSTERED SEAT

CONFERENCE, MEETING & CAFÉ



Zela multi-purpose seating lends itself perfectly to large scale conferencing, meeting rooms and single use application.

- Unique design
- Robust structure and elegant lines will complement any environment.
- Available in eight plastic colours (Backs).
- Dual linking/vertical stacking feature.

Back Plastic Colours

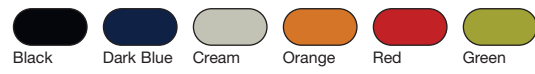

Black Plastic Underpan (Seat)



Matching Plastic Underpan (Seat)

Frame Colours



Product Features



Additional Information

Swivel Versions - Available with chrome frame only.
*Tablet version stacking is limited.

Optional Extras

Polished aluminum arm £48 surcharge
ZTROL Trolley (for 4 leg versions only)
Will stack up to 18 high

£561

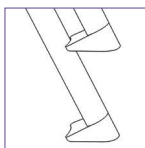

Stacking aid

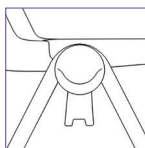

Dual link and stacking feature

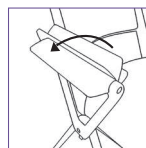

Width adjustable arm



Grey Plastic with White Frame and Gabriel Fame 66133 (Band 4) Seat

5 Year Guarantee

ZELA UPHOLSTERED SEAT CONFERENCE, MEETING & CAFÉ



ZL1SP
4 Leg (Stackable)

Band 1	£128
Band 2	£140
Band 3	£156
Band 4	£169
Band 5	£185
Band 6	£200
Band 7	£213
Leather Group 1	POA



ZLASP
4 Leg with Black Plastic Arms
(Stackable)

Band 1	£169
Band 2	£178
Band 3	£196
Band 4	£211
Band 5	£223
Band 6	£241
Band 7	£254
Leather Group 1	POA



**ZLARTSP (RH)
ZLALTSP (LH)**
4 Leg with Black Aluminium Arms and
Writing Tablet (Stackable)*

Band 1	£280
Band 2	£291
Band 3	£308
Band 4	£323
Band 5	£335
Band 6	£353
Band 7	£389
Leather Group 1	POA



ZL1SPSW
Swivel Base

Band 1	£314
Band 2	£324
Band 3	£340
Band 4	£356
Band 5	£369
Band 6	£385
Band 7	£396
Leather Group 1	POA



ZLASPSW
Swivel Base with Black Plastic Arms

Band 1	£356
Band 2	£364
Band 3	£382
Band 4	£394
Band 5	£410
Band 6	£424
Band 7	£437
Leather Group 1	POA



ZTROL

Conference,
Meeting &
Café Seating

ZELA MESH

CONFERENCE, MEETING & CAFÉ



Zela multi-purpose seating lends itself perfectly to large scale conferencing, meeting rooms and single use application.

- Unique design.
- Robust structure and elegant lines will complement any environment.
- Available in three plastic shell colours.
- Dual linking/vertical stacking feature.

Plastic Colours



Frame Colours

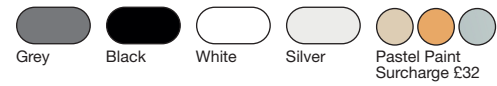

Product Features



Optional Extras

Polished aluminum arm £48 surcharge
ZTROL Trolley (for 4 leg versions only) £561
Will stack up to 18 high



Stacking aid



Dual link and stacking feature

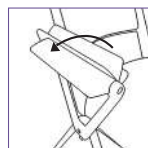

Width adjustable arm



ZLM
4 Leg

Price£155



ZLMA
4 Leg with Black Plastic Arms

Price£193



ZLMU
4 Leg with Upholstered Seat

Band 1£179
Band 2£192
Band 3£204
Band 4£219
Band 5£231
Band 6£245
Band 7£259
Leather Group 1 POA



ZLMAU
4 Leg with Upholstered Seat with Black Plastic Arms

Band 1£219
Band 2£231
Band 3£245
Band 4£259
Band 5£272
Band 6£286
Band 7£299
Leather Group 1 POA

5 Year
Guarantee

ZELA MESH

CONFERENCE, MEETING & CAFÉ



Black Plastic and Black Frame with Bute Alchemy Mimosa CF1012/1711 (Band 6) Seat

Conference,
Meeting &
Café Seating

ZELA PLASTIC

CONFERENCE, MEETING & CAFÉ



Zela multi-purpose seating lends itself perfectly to large scale conferencing, meeting rooms and single use application.

- Unique design.
- Robust structure and elegant lines will complement any environment.
- Available in eight plastic colours.
- Dual linking/vertical stacking feature.

Plastic Colours

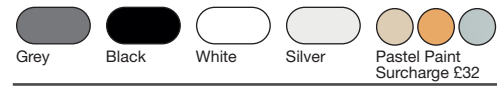
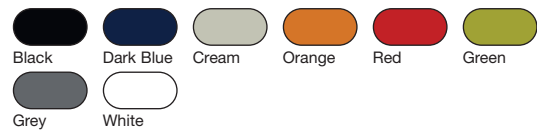

Product Features



Additional Information

Swivel Versions - Available with chrome frame only.
*Tablet version stacking is limited.

Optional Extras

Polished aluminum arm £48 surcharge
ZTROL Trolley (for 4 leg versions only) £561
Will stack up to 18 high

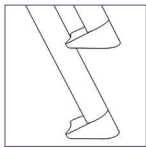

Stacking aid

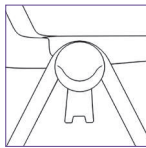

Dual link and stacking feature

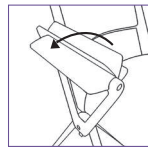

Width adjustable arm



ZL1
4 Leg (Stackable)
£104



ZLA
4 Leg with Black Plastic Arms
(Stackable)
£146



ZLART (RH)
ZLALT (LH)
4 Leg with Black Aluminium Arms and
Writing Tablet (Stackable)*
£259



ZL1SW
Swivel Base
£290



ZLASW
Swivel Base with Black Plastic Arms
£330

5 Year
Guarantee

ZELA PLASTIC CONFERENCE, MEETING & CAFÉ



Black Plastic with Grey Frame

Conference,
Meeting &
Café Seating

MEETING CHAIR

CONFERENCE, MEETING & CAFÉ



This meeting chair collection is ideal for all your conference and meeting requirements.

- Available fully upholstered, upholstered seat or all plastic.
- Each version comes with or without arms.
- Incorporated linking bracket as standard.

Plastic Colours



Black

Frame Colour



Silver

Product Features



Linking included

Optional Extras

MTM Mobile trolley (Black only) Stacks 25 (Max)

£363



5 Year Guarantee

MEETING CHAIR

CONFERENCE, MEETING & CAFÉ



M1
Plastic Seat and Back
(Stackable)
£141



MA
Plastic Seat and Back
with Arms (Stackable)
£179



MW
Plastic Seat and Back
with Writing Tablet
£264



M1SP
Upholstered Seat
(Stackable)

Band 1	£204
Band 2	£217
Band 3	£231
Band 4	£251
Band 5	£266
Band 6	£285
Band 7	£302
Leather Group 1	POA



MASP
Upholstered Seat
with Arms (Stackable)

Band 1	£245
Band 2	£255
Band 3	£273
Band 4	£290
Band 5	£306
Band 6	£324
Band 7	£340
Leather Group 1	POA



MWSP
Upholstered Seat
with Writing Tablet

Band 1	£327
Band 2	£337
Band 3	£358
Band 4	£372
Band 5	£389
Band 6	£408
Band 7	£424
Leather Group 1	POA



M1SBP
Upholstered Seat
and Back (Stackable)

Band 1	£246
Band 2	£257
Band 3	£274
Band 4	£291
Band 5	£308
Band 6	£326
Band 7	£341
Leather Group 1	POA



MASBP
Upholstered Seat and Back
with Arms (Stackable)

Band 1	£286
Band 2	£300
Band 3	£316
Band 4	£332
Band 5	£352
Band 6	£367
Band 7	£385
Leather Group 1	POA



MWSBP
Upholstered Seat
and Back with Writing Tablet

Band 1	£370
Band 2	£384
Band 3	£400
Band 4	£419
Band 5	£433
Band 6	£450
Band 7	£468
Leather Group 1	POA

Conference,
Meeting &
Café Seating

METRIC PLUS

CONFERENCE, MEETING & CAFÉ

5 Year Guarantee

Metric Plus is a family of products including swivel, four leg and cantilever chairs.

- Perfect for use throughout the office environment.
- Offered in a selection of back styles and sizes.
- Range includes fabric, plastic and mesh back options.

Plastic Colours (Available on MCHBPL and M4HBPL only)



Black

Product Features



Frame Colours

Swivel Versions - Black Polypropylene base as standard.
Cantilever / 4 Leg options - Available in chrome frames only

Optional Extras

Polished aluminium five star base £60
MCT Trolley (for 4 leg versions only) £363



MSFB

Full Back Swivel Base with Upholstered Seat and Back

Band 1	£454
Band 2	£469
Band 3	£496
Band 4	£520
Band 5	£545
Band 6	£569
Band 7	£593
Leather Group 1	£789



MSHB

Half Back Swivel Base with Upholstered Seat and Back

Band 1	£435
Band 2	£450
Band 3	£477
Band 4	£504
Band 5	£529
Band 6	£551
Band 7	£576
Leather Group 1	£768



MSHBM

Swivel Base with Mesh Back and Upholstered Seat

Band 1	£435
Band 2	£450
Band 3	£477
Band 4	£504
Band 5	£529
Band 6	£551
Band 7	£576
Leather Group 1	£768



M4HBM

4 Leg Half Mesh Back and Upholstered Seat (Stackable)

Band 1	£333
Band 2	£346
Band 3	£376
Band 4	£401
Band 5	£425
Band 6	£449
Band 7	£474
Leather Group 1	£537



MCHBM

Cantilever Half Mesh Back and Upholstered Seat (Stackable)

Band 1	£363
Band 2	£376
Band 3	£406
Band 4	£428
Band 5	£453
Band 6	£476
Band 7	£503
Leather Group 1	£567



MCHBPL

Cantilever with Plastic Seat and Back (Stackable)
£266



M4HBPL

4 Leg with Plastic Seat and Back (Stackable)
£250

5 Year
Guarantee

METRIC PLUS CONFERENCE, MEETING & CAFÉ



Conference,
Meeting &
Café Seating

From L/R 4 Leg and Cantilever with Gabriel Europost 2 68126 (Band 3) Seat

METRIC PLUS EXECUTIVE CONFERENCE, MEETING & CAFÉ

5 Year
Guarantee

Metric Plus Executive is the perfect mix of comfort and elegance.

- Available in both cantilever and 4 leg options.
- Extension of the standard Metric Plus range.
- Fits any office or managerial environment.

Product Features



Frame Colours



Chrome

Optional Extras

MCT Trolley (for 4 leg versions only) £363



MCFB
Full Back Cantilever
(Stackable)

Band 1	£411
Band 2	£425
Band 3	£453
Band 4	£476
Band 5	£503
Band 6	£526
Band 7	£550
Leather Group 1	£742



MCHB
Half Back Cantilever
(Stackable)

Band 1	£363
Band 2	£376
Band 3	£406
Band 4	£428
Band 5	£453
Band 6	£476
Band 7	£503
Leather Group 1	£694



M4FB
Full Back 4 Leg
(Stackable)

Band 1	£355
Band 2	£367
Band 3	£394
Band 4	£421
Band 5	£443
Band 6	£468
Band 7	£491
Leather Group 1	£688



M4HB
Half Back 4 Leg
(Stackable)

Band 1	£333
Band 2	£352
Band 3	£376
Band 4	£401
Band 5	£425
Band 6	£449
Band 7	£474
Leather Group 1	£667



Panaz Harvard Cream 805 (Band 3)



KEMPTON CONFERENCE, MEETING & CAFÉ

Kempton is a stylish conference chair collection. Its carefully considered design comes as standard with or without arms.

- Optional linking bracket.
- Writing tablet versions (RH/LH).
- Perfect for large scale conference or education environments.

Product Features



Frame Colours



Optional Extras

KNLNK Optional Link Bracket £25



K1
4 Leg (Stackable)

Band 1	£174
Band 2	£186
Band 3	£202
Band 4	£217
Band 5	£229
Band 6	£246
Band 7	£260
Leather Group 1	POA



KA
4 Leg With Arms
(Stackable Spirally)

Band 1	£244
Band 2	£251
Band 3	£266
Band 4	£280
Band 5	£299
Band 6	£311
Band 7	£326
Leather Group 1	POA



KWMA
4 Leg With R/H Moulded Writing
Tablet & Arms

Band 1	£306
Band 2	£316
Band 3	£331
Band 4	£346
Band 5	£362
Band 6	£373
Band 7	£389
Leather Group 1	POA



MCT
Trolley - Black
£363



Camira Blazer Knightsbridge CUZ26 (Band 4)

Conference,
Meeting &
Café Seating

MOD

CONFERENCE, MEETING & CAFÉ



Mod is a fantastic meeting and conference chair, also perfect for classrooms. It's distinctive arms and well cushioned seat provides both style and comfort for prolonged periods of sitting.

- Available with or without arms.
- Non-linking.

Product Features



Frame Colours



Grey Black Silver Chrome



MOD1
Conference Chair Black Frame

Band 1	£134
Band 2	£144
Band 3	£159
Band 4	£172
Band 5	£189
Band 6	£203
Band 7	£218
Leather Group 1	POA



MODA
Conference Chair with Arms
Black Frame

Band 1	£174
Band 2	£186
Band 3	£202
Band 4	£217
Band 5	£225
Band 6	£246
Band 7	£260
Leather Group 1	POA



Mod Chair with Arms

5 Year
Guarantee

NEW
PRODUCT

MOD CONFERENCE, MEETING & CAFÉ



Conference,
Meeting &
Café Seating

Mod Chairs with and without Arms

HEAVY DUTY CONFERENCE, MEETING & CAFÉ



This selection of fully welded frame seating is ideal for heavy use areas such as education and emergency service environments.

- Accompanied with a generous and comfortable seat pad.
- Can also be used in conference style auditoriums.

Frame Colours

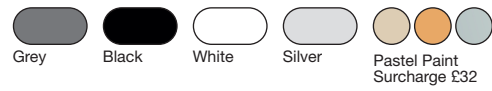

Product Features



Additional Information

* 110SWT Stackable with Tablet removed.

Optional Extras

CLF	Linking for 110C	£15
MCT	Trolley (for 4 leg versions only)	£363
MFFB	Floor fixing bracket (set of 4)	£109



Camira Xtreme Scuba YS082 (Band 1) with Grey Frame

HEAVY DUTY CONFERENCE, MEETING & CAFÉ



110C
4 Leg Heavy Duty with Curved Front Legs (Stackable)

Band 1	£172
Band 2	£186
Band 3	£210
Band 4	£232
Band 5	£250
Band 6	£274
Band 7	£293
Leather Group 1	POA



120SM
4 Leg Heavy Duty with Moulded Arms (Stackable)

Band 1	£215
Band 2	£230
Band 3	£250
Band 4	£274
Band 5	£293
Band 6	£315
Band 7	£337
Leather Group 1	POA



110SWT
4 Leg Heavy Duty with Swivel Writing Tablet (Fits Either Side) (Stackable)*

Band 1	£282
Band 2	£295
Band 3	£319
Band 4	£340
Band 5	£362
Band 6	£381
Band 7	£403
Leather Group 1	POA



LOS1
4 Leg Heavy Duty (Stackable)

Band 1	£172
Band 2	£187
Band 3	£220
Band 4	£244
Band 5	£272
Band 6	£296
Band 7	£323
Leather Group 1	POA



230
Cantilever Heavy Duty with 3/4 Back

Band 1	£226
Band 2	£243
Band 3	£274
Band 4	£300
Band 5	£328
Band 6	£354
Band 7	£379
Leather Group 1	POA



240M
Cantilever Heavy Duty with 3/4 Back and Arms

Band 1	£286
Band 2	£302
Band 3	£332
Band 4	£360
Band 5	£387
Band 6	£410
Band 7	£435
Leather Group 1	POA



210S
4 Leg Heavy Duty (Stackable)

Band 1	£195
Band 2	£211
Band 3	£242
Band 4	£270
Band 5	£293
Band 6	£320
Band 7	£347
Leather Group 1	POA



220M
4 Leg Heavy Duty with Moulded Arms

Band 1	£244
Band 2	£261
Band 3	£291
Band 4	£318
Band 5	£343
Band 6	£368
Band 7	£398
Leather Group 1	POA



310S
4 Leg Heavy Duty with Mid Back (Stackable)

Band 1	£289
Band 2	£318
Band 3	£366
Band 4	£411
Band 5	£461
Band 6	£504
Band 7	£550
Leather Group 1	POA



340M
Cantilever Heavy Duty with Moulded Arms

Band 1	£331
Band 2	£360
Band 3	£409
Band 4	£455
Band 5	£499
Band 6	£544
Band 7	£590
Leather Group 1	POA



320M
4 Leg Heavy Duty with Moulded Arms

Band 1	£356
Band 2	£387
Band 3	£434
Band 4	£479
Band 5	£525
Band 6	£571
Band 7	£615
Leather Group 1	POA



330
Cantilever Heavy Duty

Band 1	£275
Band 2	£303
Band 3	£355
Band 4	£399
Band 5	£446
Band 6	£490
Band 7	£534
Leather Group 1	POA



430
High Back Cantilever

Band 1	£403
Band 2	£432
Band 3	£482
Band 4	£526
Band 5	£575
Band 6	£621
Band 7	£667
Leather Group 1	POA



420M
High Back 4 Leg with Moulded Arms

Band 1	£490
Band 2	£519
Band 3	£569
Band 4	£611
Band 5	£660
Band 6	£703
Band 7	£749
Leather Group 1	POA



440M
High Back Cantilever

Band 1	£475
Band 2	£504
Band 3	£555
Band 4	£599
Band 5	£645
Band 6	£692
Band 7	£734
Leather Group 1	POA



410S
High Back 4 Leg Stacking

Band 1	£425
Band 2	£452
Band 3	£504
Band 4	£548
Band 5	£592
Band 6	£638
Band 7	£686
Leather Group 1	POA



120MWT
3/4 Back with Moulded Arms and Writing Tablet

Band 1	£312
Band 2	£328
Band 3	£350
Band 4	£368
Band 5	£395
Band 6	£411
Band 7	£433
Leather Group 1	POA



BAR2
Bariatric Medium Part Back Steel Frame

Band 1	£409
Band 2	£432
Band 3	£475
Band 4	£514
Band 5	£550
Band 6	£587
Band 7	£625
Leather Group 1	POA



BAR3
Bariatric Medium Full Back Steel Frame

Band 1	£606
Band 2	£631
Band 3	£671
Band 4	£706
Band 5	£745
Band 6	£784
Band 7	£823
Leather Group 1	POA

TURN CONFERENCE, MEETING & CAFÉ



- All versions stackable.
- Mesh back options - Available in Black, Grey, Red or White.

Product Features



Frame Colours

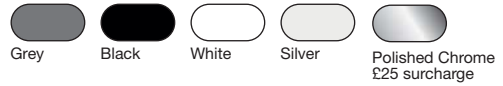

<p>TUR1 Chair Plastic Seat and Back</p> <p>Band 1 £174</p>	<p>TUR1SP Chair Upholstered Seat with Plastic Back</p> <p>Band 1 £200 Band 2 £203 Band 3 £213 Band 4 £220 Band 5 £228 Band 6 £241 Band 7 £247</p>	<p>TUR1SBP Chair Upholstered Seat and Back</p> <p>Band 1 £228 Band 2 £231 Band 3 £245 Band 4 £251 Band 5 £261 Band 6 £269 Band 7 £277</p>	<p>TURM1 Chair Mesh Back with Plastic Seat</p> <p>Band 1 £318</p>	<p>TURM1SP Chair Mesh Back with Upholstered Seat</p> <p>Band 1 £342 Band 2 £347 Band 3 £360 Band 4 £365 Band 5 £373 Band 6 £385 Band 7 £391</p>
<p>TURA Chair with Arms Plastic Seat and Back</p> <p>Band 1 £221</p>	<p>TURASP Chair with Arms Upholstered Seat with Plastic Back</p> <p>Band 1 £246 Band 2 £250 Band 3 £260 Band 4 £266 Band 5 £277 Band 6 £285 Band 7 £293</p>	<p>TURASBP Chair with Arms Upholstered Seat and Back</p> <p>Band 1 £275 Band 2 £279 Band 3 £290 Band 4 £300 Band 5 £308 Band 6 £316 Band 7 £324</p>	<p>TURMA Chair with Arms Mesh Back with Plastic Seat</p> <p>Band 1 £364</p>	<p>TURMASP Chair with Arms Mesh Back with Upholstered Seat</p> <p>Band 1 £389 Band 2 £394 Band 3 £406 Band 4 £413 Band 5 £423 Band 6 £429 Band 7 £437</p>



TURN MOBILE CONFERENCE, MEETING & CAFÉ

- All versions stackable.
- Mesh back options - Available in Black, Grey, Red or White.

Product Features



Frame Colours

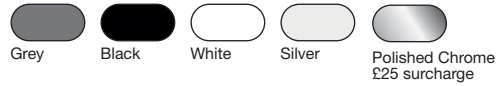

TUR1W
Mobile Chair
Plastic Seat and Back

Band 1£225

TUR1SPW
Mobile Chair
Upholstered Seat
with Plastic Back

Band 1 £239
Band 2£254
Band 3£262
Band 4£270
Band 5£279
Band 6£289
Band 7£299

TUR1SBPW
Mobile Chair
Upholstered Seat and Back

Band 1£278
Band 2£284
Band 3£293
Band 4£302
Band 5£311
Band 6£321
Band 7£327

TURM1W
Mobile Chair
Mesh Back with Plastic
Seat

Band 1£367

TURM1SPW
Mobile Chair
Mesh Back with
Upholstered Seat

Band 1 £393
Band 2£396
Band 3£408
Band 4£417
Band 5£425
Band 6£433
Band 7£442

TURAW
Mobile Chair with Arms
Plastic Seat and Back

Band 1£273

TURASPW
Mobile Chair with Arms
Upholstered Seat
with Plastic Back

Band 1 £299
Band 2£302
Band 3£311
Band 4£321
Band 5£328
Band 6£335
Band 7£345

TURASBPW
Mobile Chair with Arms
Upholstered Seat and Back

Band 1£323
Band 2£327
Band 3£335
Band 4£346
Band 5£356
Band 6£363
Band 7£370

TURMAW
Mobile Chair with Arms
Mesh Back with Plastic
Seat

Band 1£415

TURMASPW
Mobile Chair with Arms
Mesh Back with
Upholstered Seat

Band 1£438
Band 2£445
Band 3£454
Band 4£464
Band 5£473
Band 6£478
Band 7£488



INTRODUCTION

SOFT SEATING, RECEPTION & BREAKOUT

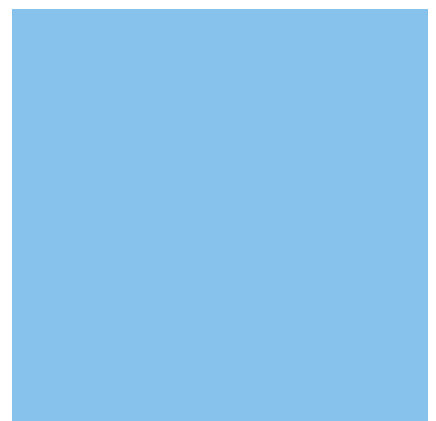
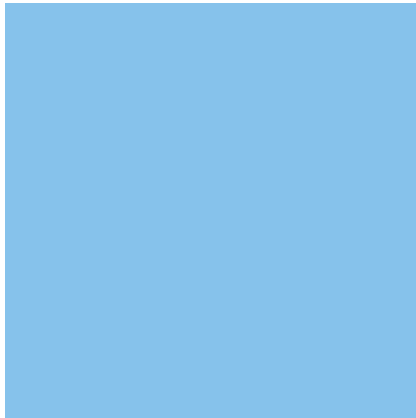

Reception,
Breakout &
Soft Seating

KEY SOFT SEATING, RECEPTION & BREAKOUT



Selected items within this range are stackable. These items are identified within the product description.

For further information regarding stacking quantity - Please contact our Sales Department.



Items are available in a variety of fabrics. A number of products possess certain upholstery restrictions - these are therefore available in selected fabrics only and are identified within this brochure.

For further information regarding fabric suitability - Please contact our Sales Department.



Arms are available on designated product ranges as indicated within the relevant product thumbnails. Colour / Finish options are indicated on relevant product pages - where applicable.

For further information regarding Arm options - Please contact our Sales Department.



Feet are available on designated product ranges as indicated within the relevant product thumbnails. Colour / Finish options are indicated on relevant product pages - where applicable.

For further information regarding Feet options - Please contact our Sales Department.



Items include Reflex Foam Structure as standard.

Level 'S' tested to BS5459: Part 2: 2000.

Extreme Comfort.

Consistent Shape Retention.

Durability and long life.

Excellent Fire Retardant Properties.

We recommend that you request fabric samples prior to ordering.

Two tone upholstery is available on selected products. Please contact our Sales Department for further information.

You can find dimensions for all products in the technical data section of this brochure.

Please Note: All images shown are for illustrative purposes.

Some aspects of certain products may differ. Please contact our customer services department with any queries.

RELO

SOFT SEATING, RECEPTION & BREAKOUT

NEW
PRODUCT

5 Year
Guarantee



Reception,
Breakout &
Soft Seating



RELO

SOFT SEATING, RECEPTION & BREAKOUT

Relo

Crafted with patience, Relo takes inspiration from the smooth forms found on beaches, oceans and seas, aiming to transport the calming characteristics of these habitats to the workspace furthermore echoing their nomadic nature. Available in a Static or Swivel base with either a Fully Upholstered or Tech PU Shroud.

Product Features



Base Colours

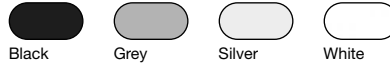

Tech PU Shroud Options



RELOST1
Upholstered Shroud
with Static Base

Band 1	£2,267
Band 2	£2,384
Band 3	£2,544
Band 4	£2,686
Band 5	£2,850
Band 6	£2,998
Band 7	£3,140



RELOST2
Tech PU Shroud
with Static Base

Band 1	£2,037
Band 2	£2,083
Band 3	£2,147
Band 4	£2,204
Band 5	£2,269
Band 6	£2,328
Band 7	£2,386



RELOSW1
Upholstered Shroud
with Swivel Base

Band 1	£2,446
Band 2	£2,563
Band 3	£2,722
Band 4	£2,863
Band 5	£3,029
Band 6	£3,177
Band 7	£3,320



RELOSW2
Tech PU Shroud
with Swivel Base

Band 1	£2,216
Band 2	£2,263
Band 3	£2,326
Band 4	£2,383
Band 5	£2,449
Band 6	£2,508
Band 7	£2,566



Reception,
Breakout &
Soft Seating

KLYRO HIGH BACK

RECEPTION, BREAKOUT & SOFT SEATING



Stylish, elegant and iconic. The Klyro Family is a fabulous new addition to the Gresham portfolio, forming an exciting selection of lounge and meeting chairs that between them offer an elegant and high-quality appearance, perfect for any environment. Klyro's crisp upholstery combines with several base options to form a versatile contemporary design ideal for both workplace and hospitality spaces. A family comprising of armchair, High wing back and Low back options, is complimented by both high and low back two-seat sofa models, all which share a strong family resemblance.

Product Features



Leg Colours



KLY1H8
1 Seater Lounge Chair with Wooden Spindle Base

Band 1	£1,265
Band 2	£1,348
Band 3	£1,465
Band 4	£1,569
Band 5	£1,688
Band 6	£1,794
Band 7	£1,898
Leather Group 1	POA



KLY1H1
1 Seater Lounge Chair with Wooden 4 Leg Base

Band 1	£1,482
Band 2	£1,565
Band 3	£1,680
Band 4	£1,785
Band 5	£1,917
Band 6	£2,012
Band 7	£2,118
Leather Group 1	POA



KLY1H4
1 Seater Lounge Chair with Wooden Cradle Base

BBand 1	£1,535
Band 2	£1,621
Band 3	£1,738
Band 4	£1,839
Band 5	£1,960
Band 6	£2,067
Band 7	£2,171
Leather Group 1	POA



KLY1H2
1 Seater Lounge Chair with Wooden Pyramid Swivel Base

Band 1	£1,564
Band 2	£1,649
Band 3	£1,764
Band 4	£1,869
Band 5	£1,988
Band 6	£2,095
Band 7	£2,200
Leather Group 1	POA



KLY1H7
1 Seater Lounge Chair with Sled Base

Band 1	£1,370
Band 2	£1,392
Band 3	£1,571
Band 4	£1,673
Band 5	£1,793
Band 6	£1,900
Band 7	£2,005
Leather Group 1	POA



KLY1H5
1 Seater Lounge Chair with 4 Star Swivel Base

Band 1	£1,523
Band 2	£1,607
Band 3	£1,723
Band 4	£1,825
Band 5	£1,946
Band 6	£2,053
Band 7	£2,158
Leather Group 1	POA



KLY1H3
1 Seater Lounge Chair with 4 Leg Base

Band 1	£1,531
Band 2	£1,616
Band 3	£1,732
Band 4	£1,835
Band 5	£1,955
Band 6	£2,062
Band 7	£2,167
Leather Group 1	POA



KLY2H4
2 Seater Lounge Chair with Wooden Cradle Base

Band 1	£2,754
Band 2	£2,902
Band 3	£3,105
Band 4	£3,285
Band 5	£3,496
Band 6	£3,682
Band 7	£3,866
Leather Group 1	POA



KLY2H2
2 Seater Lounge Chair with Wooden Pyramid Base

Band 1	£2,720
Band 2	£2,870
Band 3	£3,072
Band 4	£3,252
Band 5	£3,463
Band 6	£3,650
Band 7	£3,833
Leather Group 1	POA



KLY2H7
2 Seater Lounge Chair with Sled Base

Band 1	£2,519
Band 2	£2,669
Band 3	£2,873
Band 4	£3,051
Band 5	£3,262
Band 6	£3,449
Band 7	£3,632
Leather Group 1	POA



KLY2H3
2 Seater Lounge Chair with 4 Leg Base

Band 1	£2,821
Band 2	£2,969
Band 3	£3,173
Band 4	£3,351
Band 5	£3,562
Band 6	£3,750
Band 7	£3,932
Leather Group 1	POA

5 Year
Guarantee

NEW
PRODUCT

KLYRO HIGH BACK

RECEPTION, BREAKOUT & SOFT SEATING

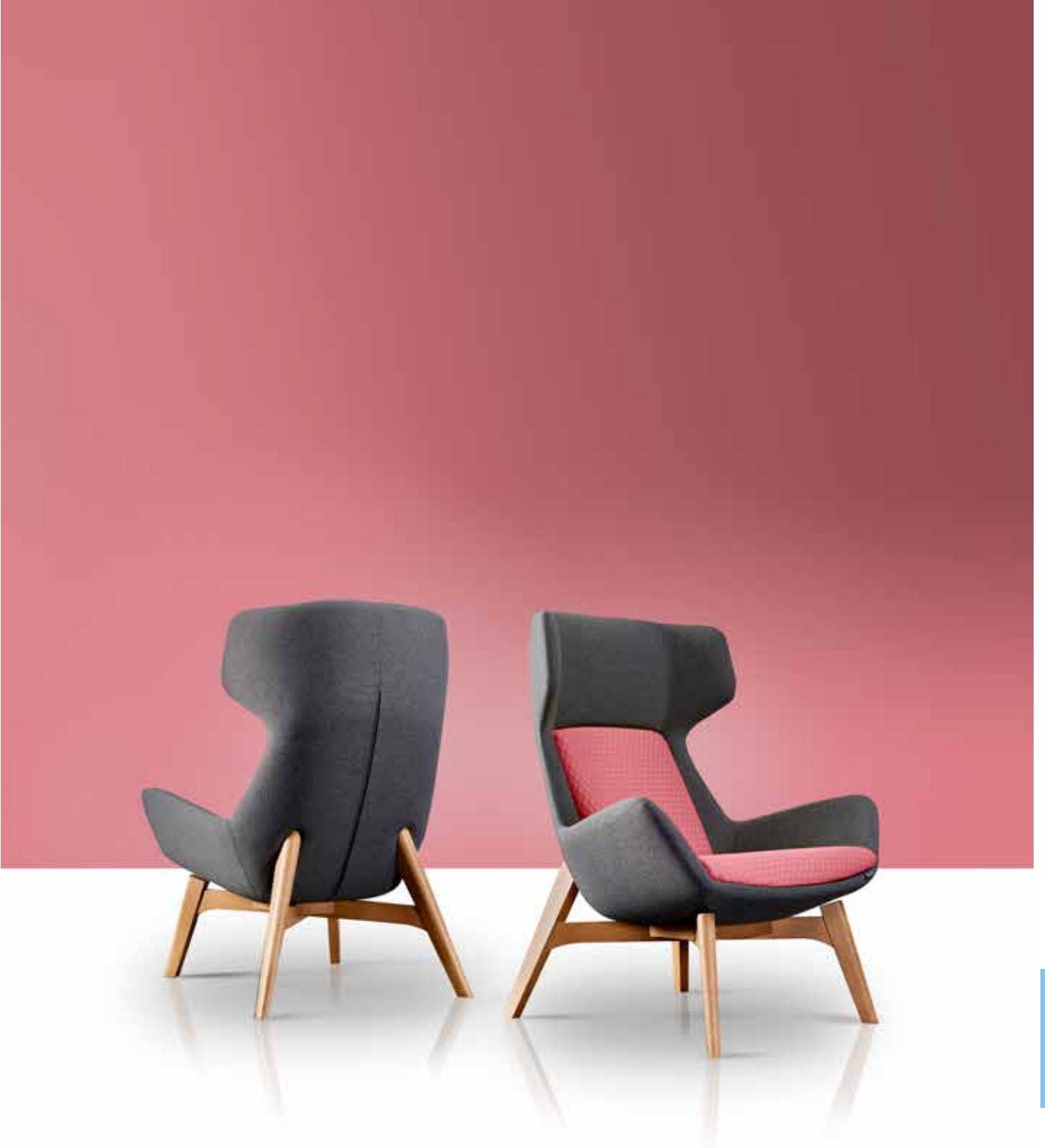

Reception,
Breakout &
Soft Seating

KLYRO LOW BACK

RECEPTION, BREAKOUT & SOFT SEATING



Stylish, elegant and iconic. The Klyro Family is a fabulous new addition to the Gresham portfolio, forming an exciting selection of lounge and meeting chairs that between them offer an elegant and high-quality appearance, perfect for any environment. Klyro's crisp upholstery combines with several base options to form a versatile contemporary design ideal for both workplace and hospitality spaces. A family comprising of armchair, High wing back and Low back options, is complimented by both high and low back two-seat sofa models, all which share a strong family resemblance.

Product Features



Leg Colours



KLY1L8
1 Seater Lounge Chair with Wooden Spindle Base

Band 1	£1,145
Band 2	£1,220
Band 3	£1,323
Band 4	£1,411
Band 5	£1,516
Band 6	£1,611
Band 7	£1,701
Leather Group 1	POA



KLY1L1
1 Seater Lounge Chair with Wooden 4 Leg Base

Band 1	£1,363
Band 2	£1,436
Band 3	£1,538
Band 4	£1,630
Band 5	£1,733
Band 6	£1,829
Band 7	£1,920
Leather Group 1	POA



KLY1L4
1 Seater Lounge Chair with Wooden Cradle Base

Band 1	£1,418
Band 2	£1,493
Band 3	£1,594
Band 4	£1,685
Band 5	£1,790
Band 6	£1,882
Band 7	£1,975
Leather Group 1	POA



KLY1L2
1 Seater Lounge Chair with Wooden Pyramid Swivel Base

Band 1	£1,447
Band 2	£1,519
Band 3	£1,622
Band 4	£1,713
Band 5	£1,818
Band 6	£1,911
Band 7	£2,003
Leather Group 1	POA



KLY1L7
1 Seater Lounge Chair with Sled Base

Band 1	£1,252
Band 2	£1,326
Band 3	£1,427
Band 4	£1,517
Band 5	£1,622
Band 6	£1,716
Band 7	£1,808
Leather Group 1	POA



KLY1L5
1 Seater Lounge Chair with 4 Star Swivel Base

Band 1	£1,405
Band 2	£1,478
Band 3	£1,579
Band 4	£1,671
Band 5	£1,776
Band 6	£1,869
Band 7	£1,961
Leather Group 1	POA



KLY1L3
1 Seater Lounge Chair with 4 Leg Base

Band 1	£1,413
Band 2	£1,487
Band 3	£1,589
Band 4	£1,678
Band 5	£1,783
Band 6	£1,878
Band 7	£1,969
Leather Group 1	POA



KLY2L4
2 Seater Lounge Chair with Wooden Cradle Base

Band 1	£2,533
Band 2	£2,671
Band 3	£2,860
Band 4	£3,025
Band 5	£3,222
Band 6	£3,395
Band 7	£3,566
Leather Group 1	POA



KLY2L2
2 Seater Lounge Chair with Wooden Pyramid Base

Band 1	£2,498
Band 2	£2,638
Band 3	£2,826
Band 4	£2,993
Band 5	£3,189
Band 6	£3,363
Band 7	£3,531
Leather Group 1	POA



KLY2L7
2 Seater Lounge Chair with Sled Base

Band 1	£2,299
Band 2	£2,436
Band 3	£2,627
Band 4	£2,793
Band 5	£2,987
Band 6	£3,162
Band 7	£3,332
Leather Group 1	POA



KLY2L3
2 Seater Lounge Chair with 4 Leg Base

Band 1	£2,599
Band 2	£2,738
Band 3	£2,926
Band 4	£3,092
Band 5	£3,289
Band 6	£3,463
Band 7	£3,632
Leather Group 1	POA

Reception, Breakout & Soft Seating

5 Year
Guarantee

NEW
PRODUCT

KLYRO LOW BACK

RECEPTION, BREAKOUT & SOFT SEATING



Reception,
Breakout &
Soft Seating

KLYRO MEETING CHAIR

RECEPTION, BREAKOUT & SOFT SEATING



Stylish, elegant and iconic. The Klyro Family is a fabulous new addition to the Gresham portfolio, forming an exciting selection of lounge and meeting chairs that between them offer an elegant and high-quality appearance, perfect for any environment. Klyro's crisp upholstery combines with several base options to form a versatile contemporary design ideal for both workplace and hospitality spaces. A family comprising of armchair, High wing back and Low back options, is complimented by both high and low back two-seat sofa models, all which share a strong family resemblance.

Product Features



Leg Colours



KLY1AR8
Meeting Chair
with Wooden Spindle Base

Band 1	£883
Band 2	£953
Band 3	£1,008
Band 4	£1,049
Band 5	£1,100
Band 6	£1,138
Band 7	£1,172
Leather Group 1	POA



KLY1AR1
Meeting Chair
with Wooden 4 Leg Base

Band 1	£892
Band 2	£950
Band 3	£1,028
Band 4	£1,100
Band 5	£1,182
Band 6	£1,255
Band 7	£1,328
Leather Group 1	POA



KLY1AR7
Meeting Chair
with Sled Base

Band 1	£761
Band 2	£820
Band 3	£899
Band 4	£970
Band 5	£1,053
Band 6	£1,126
Band 7	£1,198
Leather Group 1	POA



KLY1AR5
Meeting Chair
with 4 Leg Swivel Base

Band 1	£956
Band 2	£1,013
Band 3	£1,095
Band 4	£1,164
Band 5	£1,247
Band 6	£1,320
Band 7	£1,391
Leather Group 1	POA



KLY1AR6
Meeting Chair
with Pyramid Swivel Base

Band 1	£914
Band 2	£973
Band 3	£1,053
Band 4	£1,124
Band 5	£1,205
Band 6	£1,280
Band 7	£1,357
Leather Group 1	POA



KLYP1
Pouf with
4 Leg Base

Band 1	£705
Band 2	£734
Band 3	£775
Band 4	£809
Band 5	£851
Band 6	£886
Band 7	£923
Leather Group 1	POA



KLYP5
Pouf with Wooden
4 Leg Base

Band 1	£749
Band 2	£777
Band 3	£817
Band 4	£853
Band 5	£895
Band 6	£931
Band 7	£966
Leather Group 1	POA



KLYP2
Pouf with Wooden
Pyramid Swivel Base

Band 1	£676
Band 2	£706
Band 3	£747
Band 4	£781
Band 5	£822
Band 6	£858
Band 7	£896
Leather Group 1	POA

5 Year
Guarantee

NEW
PRODUCT

KLYRO MEETING CHAIR

RECEPTION, BREAKOUT & SOFT SEATING



Reception,
Breakout &
Soft Seating

STEPS SWIVEL BASE

SOFT SEATING, RECEPTION & BREAKOUT



The Steps Swivel Base chair is ideal for meeting rooms and foyers. It comes with an optional high, wing-backed headrest perfect for executive breakout spaces or reception areas where style is paramount.

Available in a variety of fabrics with the option of being finished with a contrasting wood surround which accentuates the sophistication of the model.

Product Features



Frame Colours



Show Wood Colours



Lacquer Colours



Subject to Surcharge, please contact our Sales Department for further information



STCS
Compact Swivel No Surround

Band 3	£1,064
Band 4	£1,089
Band 5	£1,120
Band 6	£1,146
Band 7	£1,171



STCSAU
Compact Swivel Upholstered Surround

Band 3	£1,329
Band 4	£1,381
Band 5	£1,440
Band 6	£1,492
Band 7	£1,546



STCSAW
Compact Swivel Show Wood Surround

Band 3	£1,387
Band 4	£1,430
Band 5	£1,478
Band 6	£1,523
Band 7	£1,564



STLS
Lounge Swivel No Surround

Band 3	£1,239
Band 4	£1,272
Band 5	£1,312
Band 6	£1,346
Band 7	£1,382



STLSAU
Lounge Swivel Upholstered Surround

Band 3	£1,554
Band 4	£1,620
Band 5	£1,695
Band 6	£1,762
Band 7	£1,833



STLSAW
Lounge Swivel Show Wood Surround

Band 3	£1,686
Band 4	£1,745
Band 5	£1,814
Band 6	£1,875
Band 7	£1,935



STLSAHU
Lounge Swivel Upholstered Surround/Headrest

Band 3	£2,012
Band 4	£2,131
Band 5	£2,265
Band 6	£2,386
Band 7	£2,507



STLSAHW
Lounge Swivel Show Wood Surround/Headrest

Band 3	£2,276
Band 4	£2,393
Band 5	£2,496
Band 6	£2,602
Band 7	£2,706

5 Year
Guarantee

STEPS SWIVEL BASE

SOFT SEATING, RECEPTION & BREAKOUT



Reception,
Breakout &
Soft Seating

STEPS SWIVEL WOOD CLAD BASE

SOFT SEATING, RECEPTION & BREAKOUT

5 Year Guarantee

The Steps Swivel Wood Clad Base chair is perfect for executive offices, finished with a contrasting wooden base which accentuates the sophistication of the model. It comes with an optional high, wing-backed headrest perfect for breakout spaces or reception areas where style is paramount.

Available in a variety of fabrics.

Product Features



Base Colours



Dark Walnut

Show Wood Colours



Dark Walnut



STCSB
Compact Swivel Wood Base
No Surround

Band 3	£1,547
Band 4	£1,571
Band 5	£1,601
Band 6	£1,629
Band 7	£1,652



STCSAUB
Compact Swivel Wood Base
Upholstered Surround

Band 3	£1,810
Band 4	£1,861
Band 5	£1,921
Band 6	£1,974
Band 7	£2,026



STCSAWB
Compact Swivel Wood Base
Show Wood Surround

Band 3	£1,866
Band 4	£1,912
Band 5	£1,960
Band 6	£2,003
Band 7	£2,047



STLSB
Lounge Swivel Wood Base
No Surround

Band 3	£1,719
Band 4	£1,754
Band 5	£1,792
Band 6	£1,829
Band 7	£1,862



STLSAUB
Lounge Swivel Wood Base
Upholstered Surround

Band 3	£2,034
Band 4	£2,103
Band 5	£2,177
Band 6	£2,247
Band 7	£2,313



STLSAWB
Lounge Swivel Wood Base
Show Wood Surround

Band 3	£2,166
Band 4	£2,226
Band 5	£2,293
Band 6	£2,355
Band 7	£2,415



STLSAHUB
Lounge Swivel Wood Base
Upholstered Surround/Headrest

Band 3	£2,493
Band 4	£2,613
Band 5	£2,748
Band 6	£2,867
Band 7	£2,986



STLSAHWB
Lounge Swivel Wood Base
Show Wood Surround/Headrest

Band 3	£2,757
Band 4	£2,874
Band 5	£2,979
Band 6	£3,083
Band 7	£3,188

Reception,
Breakout &
Soft Seating

5 Year
Guarantee

STEPS SWIVEL WOOD CLAD BASE SOFT SEATING, RECEPTION & BREAKOUT



Reception,
Breakout &
Soft Seating

STEPS SLED BASE

SOFT SEATING, RECEPTION & BREAKOUT

5 Year Guarantee

The Steps Sled Base chair is ideal for meeting rooms and foyers. It comes with an optional high, wing-backed headrest perfect for executive breakout spaces or reception areas where style is paramount.

Available in a variety of fabrics with the option of being finished with a contrasting wood surround which accentuates the sophistication of the model.

Product Features



Frame Colours



Show Wood Colours



Dark Walnut

Lacquer Colours

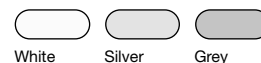

White Silver Grey

Subject to Surcharge, please contact our Sales Department for further information



STCB
Compact Sled No Surround

Band 3	£960
Band 4	£984
Band 5	£1,014
Band 6	£1,040
Band 7	£1,065



STCBAU
Compact Sled Upholstered Surround

Band 3	£1,223
Band 4	£1,273
Band 5	£1,333
Band 6	£1,387
Band 7	£1,438



STCBAW
Compact Sled Show Wood Surround

Band 3	£1,281
Band 4	£1,326
Band 5	£1,372
Band 6	£1,416
Band 7	£1,458



STLB
Lounge Sled No Surround

Band 3	£1,117
Band 4	£1,151
Band 5	£1,190
Band 6	£1,225
Band 7	£1,260



STLBAU
Lounge Sled Upholstered Surround

Band 3	£1,431
Band 4	£1,498
Band 5	£1,575
Band 6	£1,642
Band 7	£1,710



STLBAW
Lounge Sled Show Wood Surround

Band 3	£1,562
Band 4	£1,622
Band 5	£1,692
Band 6	£1,752
Band 7	£1,814



STLBAHU
Lounge Sled Upholstered Surround/Headrest

Band 3	£1,890
Band 4	£2,009
Band 5	£2,143
Band 6	£2,264
Band 7	£2,385



STLBAHW
Lounge Sled Show Wood Surround/Headrest

Band 3	£2,153
Band 4	£2,257
Band 5	£2,374
Band 6	£2,479
Band 7	£2,582

5 Year
Guarantee

STEPS SLED BASE SOFT SEATING, RECEPTION & BREAKOUT



Reception,
Breakout &
Soft Seating

STEPS 4 STAR BASE

SOFT SEATING, RECEPTION & BREAKOUT



Adding to the Steps family of contemporary lounge seating, we have introduced stylish Aluminium die-cast pyramid bases that mirror the clean, sweeping lines of the upholstery whilst reducing both the physical and visual weight of the chairs.

Available in a variety of fabrics with the option of being finished in a contrasting wood surround which accentuates the sophistication of the model.

Product Features



Frame Colours



Show Wood Colours



Dark Walnut

Lacquer Colours



White Silver Grey

Subject to Surcharge, please contact our Sales Department for further information



STCDG
Compact 4 Star No Surround

Band 3	£1,064
Band 4	£1,089
Band 5	£1,120
Band 6	£1,146
Band 7	£1,171



STCDGAU
Compact 4 Star Upholstered Surround

Band 3	£1,329
Band 4	£1,381
Band 5	£1,440
Band 6	£1,492
Band 7	£1,546



STCDGAW
Compact 4 Star Show Wood Surround

Band 3	£1,387
Band 4	£1,430
Band 5	£1,478
Band 6	£1,523
Band 7	£1,564



STLDG
Lounge 4 Star No Surround

Band 3	£1,239
Band 4	£1,272
Band 5	£1,312
Band 6	£1,346
Band 7	£1,382



STLDGAU
Lounge 4 Star Upholstered Surround

Band 3	£1,554
Band 4	£1,620
Band 5	£1,695
Band 6	£1,762
Band 7	£1,833



STLDGAW
Lounge 4 Star Show Wood Surround

Band 3	£1,686
Band 4	£1,745
Band 5	£1,814
Band 6	£1,875
Band 7	£1,935



STLDGAHU
Lounge 4 Star Upholstered Surround/Headrest

Band 3	£2,012
Band 4	£2,131
Band 5	£2,265
Band 6	£2,386
Band 7	£2,507



STLDGAHW
Lounge 4 Star Show Wood Surround/Headrest

Band 3	£2,276
Band 4	£2,393
Band 5	£2,496
Band 6	£2,602
Band 7	£2,706

Reception, Breakout & Soft Seating

5 Year
Guarantee

STEPS 4 STAR BASE SOFT SEATING, RECEPTION & BREAKOUT



Reception,
Breakout &
Soft Seating

STEPS CASTOR BASE

SOFT SEATING, RECEPTION & BREAKOUT



Adding to the Steps family of contemporary lounge seating, we have introduced stylish Aluminium die-cast pyramid bases that mirror the clean, sweeping lines of the upholstery whilst reducing both the physical and visual weight of the chairs.

Available in a variety of fabrics with the option of being finished in a contrasting wood surround which accentuates the sophistication of the model.

Product Features



Frame Colours

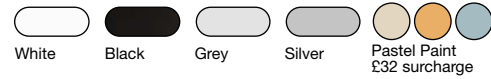

Show Wood Colours



Lacquer Colours

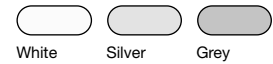

Subject to Surcharge, please contact our Sales Department for further information



STCDM
Compact Castor No Surround

Band 3	£1,075
Band 4	£1,101
Band 5	£1,129
Band 6	£1,157
Band 7	£1,183



STCDMAU
Compact Castor Upholstered Surround

Band 3	£1,339
Band 4	£1,390
Band 5	£1,450
Band 6	£1,502
Band 7	£1,555



STCDMAW
Compact Castor Show Wood Surround

Band 3	£1,396
Band 4	£1,440
Band 5	£1,489
Band 6	£1,531
Band 7	£1,577

5 Year
Guarantee

STEPS CASTOR BASE

SOFT SEATING, RECEPTION & BREAKOUT



Reception,
Breakout &
Soft Seating

Kvadrat Remix 2 0123 (Band 4) Inner and Kvadrat Remix 2 0433 (Band 4) Outer with Black Castor Base

HECTA

SOFT SEATING, RECEPTION & BREAKOUT

5 Year Guarantee

This classically designed chair is both timeless and elegant. Its moulded seat shell and tailored upholstery provide a feeling of luxury and comfort.

The high-back wing chair also offers a sense of tranquillity due to it's acoustic properties and as such is perfect for breakout areas, lounges and busy spaces where an oasis of peace is desired.

The Hecta is available with three styles of base with either one-tone or two-tone upholstery which has comfort as well as a look which is contemporary as well as timeless and elegant.

Metal Base Colours



Wooden Base Colours



Product Features



Please Note

Available in selected fabrics only - Please contact our Sales Department for further information.



HECW
Upholstered Arm Chair
with 4 Leg Wooden Base

Band 1	£1,679
Band 2	£1,733
Band 3	£1,808
Band 4	£1,878
Band 5	£1,954
Band 6	£2,024
Band 7	£2,092



HECS
Upholstered Arm Chair
with 4 Star Base

Band 1	£1,718
Band 2	£1,774
Band 3	£1,846
Band 4	£1,916
Band 5	£1,994
Band 6	£2,063
Band 7	£2,131



HECP
Upholstered Arm Chair
with Pyramid Wooden Base

Band 1	£1,723
Band 2	£1,779
Band 3	£1,852
Band 4	£1,922
Band 5	£2,000
Band 6	£2,068
Band 7	£2,139



Hecta: Camira Blazer Silverdale with Pyramid Wooden Base. Kulture: Capaldi Seat Unit Kvadrat Canvas 2 0114 & 0614



HECTA

SOFT SEATING, RECEPTION & BREAKOUT



Reception,
Breakout &
Soft Seating

Hecta: Camira Blazer Eynesbury CUZ2W with 4 Star Base

LITTLE HECTA

SOFT SEATING, RECEPTION & BREAKOUT



Little Hecta joins the Gresham portfolio as a complementary side chair with strong ties to its sister product Hecta. A classic silhouette combined with detailed upholstery helps this versatile range provide a playful blend of luxury and comfort. Little Hecta is available with four styles of base and a choice of one or two-tone upholstery making it appropriate for specification through various applications in both hospitality and office environments.

- Moulded Foam Construction
- Fully Upholstered
- Steel Swivel Pedestal Base Options
- Wood Base Options
- Decorative Railroad Stitch Detail to Perimeter Seam
- Single or Two-tone Upholstery

Product Features



Metal Base Colours



Wooden Base Colours



HECWCH
Meeting Chair with
Wooden 4 Leg Base

Band 1	£927
Band 2	£951
Band 3	£982
Band 4	£1,010
Band 5	£1,043
Band 6	£1,073
Band 7	£1,102
Leather Group 1	POA



HECPCCH
Meeting Chair with
Wooden Pyramid Base

Band 1	£921
Band 2	£942
Band 3	£972
Band 4	£997
Band 5	£1,026
Band 6	£1,054
Band 7	£1,080
Leather Group 1	POA



HECSCH
Meeting Chair with
Metal 4 Star Base

Band 1	£850
Band 2	£869
Band 3	£896
Band 4	£919
Band 5	£947
Band 6	£972
Band 7	£995
Leather Group 1	POA



HECKCH
Meeting Chair with
Metal Pyramid Base

Band 1	£901
Band 2	£922
Band 3	£952
Band 4	£978
Band 5	£1,007
Band 6	£1,035
Band 7	£1,059
Leather Group 1	POA



5 Year
Guarantee

NEW
PRODUCT

LITTLE HECTA

SOFT SEATING, RECEPTION & BREAKOUT

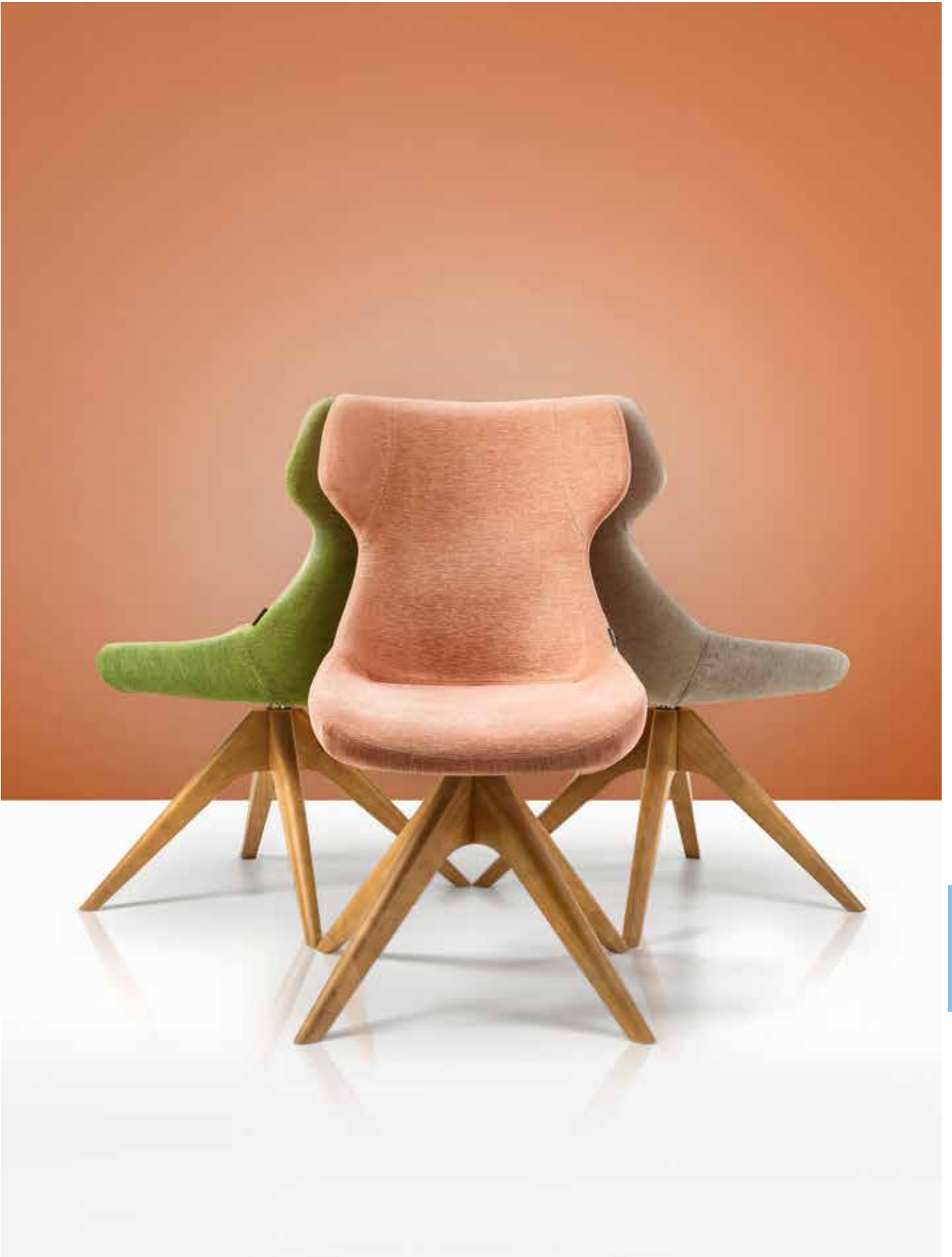

Reception,
Breakout &
Soft Seating

MASCA

SOFT SEATING, RECEPTION & BREAKOUT



Masca is a contemporary lounge chair family offered in high and medium back options, with either a polished 4-star base or wooden four legged frame.

This style is ideal for receptions, waiting or lounge areas where comfort and panache are paramount.

Metal Base Colours



Polished

Wooden Base Colours



Natural



Dark Walnut

Product Features



Please Note

Available in selected fabrics only - Please contact our Sales Department for further information.



MASC11
Medium Back 4 Star Base
(with Glides)

Band 4	£1,204
Band 5	£1,229
Band 6	£1,252
Band 7	£1,273
Leather Group 1	POA



MASC12
Medium Back 4 Star Castor
Base
(with Castors)

Band 4	£1,219
Band 5	£1,244
Band 6	£1,267
Band 7	£1,287
Leather Group 1	POA



MASC13
Medium Back Pyramid
Base

Band 4	£1,286
Band 5	£1,312
Band 6	£1,333
Band 7	£1,357
Leather Group 1	POA



MASC14
Medium Back Pyramid
Base
(with Castors)

Band 4	£1,301
Band 5	£1,327
Band 6	£1,347
Band 7	£1,370
Leather Group 1	POA



MASC4
Medium Back Wooden
Frame

Band 4	£1,220
Band 5	£1,281
Band 6	£1,339
Band 7	£1,397
Leather Group 1	POA



MASC21
High Back 4 Star Base
(with Glides)

Band 4	£1,362
Band 5	£1,388
Band 6	£1,410
Band 7	£1,431
Leather Group 1	POA



MASC22
High Back 4 Star Castor
Base
(with Castors)

Band 4	£1,375
Band 5	£1,401
Band 6	£1,424
Band 7	£1,446
Leather Group 1	POA



MASC23
High Back Pyramid Base
(with Glides)

Band 4	£1,412
Band 5	£1,436
Band 6	£1,458
Band 7	£1,483
Leather Group 1	POA



MASC24
High Back Pyramid Base
(with Castors)

Band 4	£1,425
Band 5	£1,450
Band 6	£1,471
Band 7	£1,494
Leather Group 1	POA



MASC2
High Back Wooden Frame

Band 4	£1,375
Band 5	£1,448
Band 6	£1,518
Band 7	£1,588
Leather Group 1	POA

Reception,
Breakout &
Soft Seating

5 Year
Guarantee

MASCA

SOFT SEATING, RECEPTION & BREAKOUT

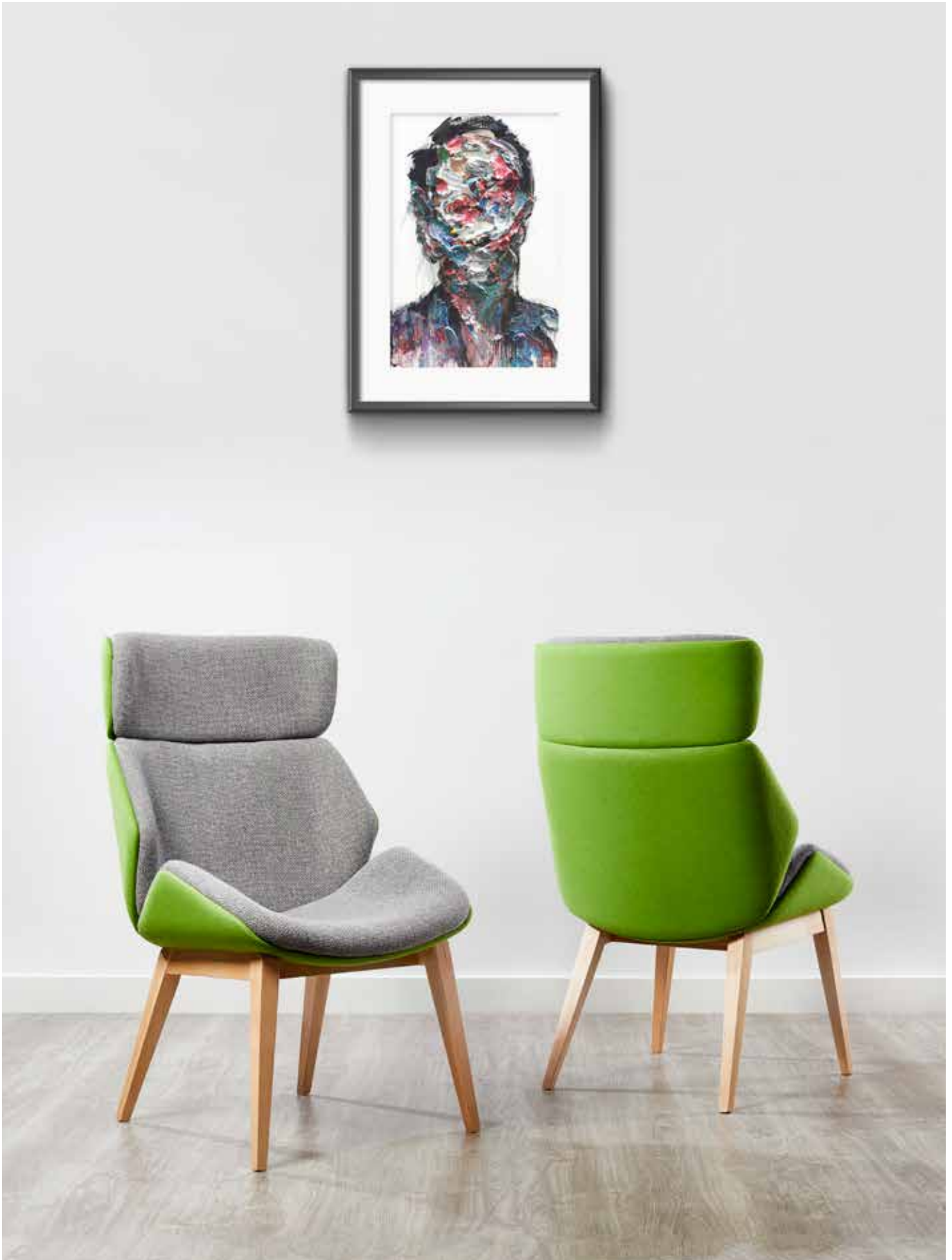

Reception,
Breakout &
Soft Seating

Camira Blazer Newport CUZ1L (Band 4) Outer and Camira Advantage Mineral AD010 (Band 1) Inner with Natural Wooden Legs

BETSY

SOFT SEATING, RECEPTION & BREAKOUT



Betsy has been designed as a contemporary tub lounge chair collection with sweeping curves and a selection of stylish frames. Available in single and two seat variants, the Betsy family can be used throughout corporate environments where comfort and light-weight visual style is key.

- Available in Two-tone fabric and a choice of bases.
- Generous seat & back for added comfort.
- Four star bases fitted with gas lift mechanism, raising the chair from reception to work/dining height.
- Matching tables available.

Frame Finishes

Metal

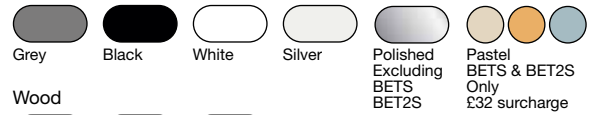

Wood



Product Features



Please Note

Band 1 and Band 2 are available as selected fabrics only - Please contact our Sales Department for further information.



BET2S
Two Seat Sofa Skid Frame



BET2Z
Two Seat Sofa Wooden Frame

Band 1	£1,192
Band 2	£1,243
Band 3	£1,320
Band 4	£1,392
Band 5	£1,467
Band 6	£1,537
Band 7	£1,607

Band 1	£1,411
Band 2	£1,463
Band 3	£1,542
Band 4	£1,609
Band 5	£1,687
Band 6	£1,758
Band 7	£1,829



Camira Rivet Crucibal EGL24 (Band 1) Inner and Svensson Accessoire Bok (Band 6) Outer with Black Skid Frame

BETSY

SOFT SEATING, RECEPTION & BREAKOUT



BETS
Skid Frame

Band 1	£637
Band 2	£662
Band 3	£700
Band 4	£735
Band 5	£775
Band 6	£809
Band 7	£842
Leather Group 1	POA



BET4
Four Star Base
(With Glides)
R / T

Band 1	£849
Band 2	£872
Band 3	£914
Band 4	£948
Band 5	£985
Band 6	£1,022
Band 7	£1,056
Leather Group 1	POA



BET4W
Four Star Base
(With Castors)
T

Band 1	£867
Band 2	£895
Band 3	£934
Band 4	£967
Band 5	£1,007
Band 6	£1,041
Band 7	£1,079
Leather Group 1	POA



BETP
Pyramid Base
(With Glides)
R

Band 1	£891
Band 2	£916
Band 3	£954
Band 4	£989
Band 5	£1,027
Band 6	£1,063
Band 7	£1,097
Leather Group 1	POA



BETPW
Pyramid Base
(With Castors)
R

Band 1	£906
Band 2	£934
Band 3	£973
Band 4	£1,007
Band 5	£1,046
Band 6	£1,082
Band 7	£1,116
Leather Group 1	POA



BETZ
Wooden Frame

Band 1	£983
Band 2	£1,009
Band 3	£1,050
Band 4	£1,084
Band 5	£1,122
Band 6	£1,158
Band 7	£1,191
Leather Group 1	POA

R. Optional Auto Return Column available.
(Suffix code with R. Example: BET4R)
Surcharge.....£13

T. Optional Tilt Mechanism available.
(Suffix code with T. Example: BET4T)
Surcharge.....£45



From L/R Camira Rivet Spark EGL10 (Band 1) Inner and Svensson Accessoire Riff (Band 6) Outer with White Pyramid Base
Camira Rivet Crucibal EGL24 (Band 1) Inner and Svensson Accessoire Bok (Band 6) Outer with Black Skid Frame with White Pyramid Base

ADORE

SOFT SEATING, RECEPTION & BREAKOUT

5 Year Guarantee

As the name suggests, you'll just love this family of contemporary lounge chairs with matching stool.

- The concave form of its shell holds you in place for a relaxing sit.
- Choice of widths and frame options.
- Easy to specify throughout your working landscape.

Frame Colours

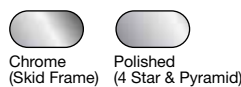

Product Features



Please Note

Available in selected fabrics only - Please contact our Sales Department for further information.



AD1
Low Skid Frame with Headrest

Band 1	£748
Band 2	£776
Band 3	£831
Band 4	£881
Band 5	£928
Band 6	£977
Band 7	£1,025
Leather Group 1	POA



AD2
Low Skid Frame

Band 1	£662
Band 2	£689
Band 3	£731
Band 4	£768
Band 5	£806
Band 6	£846
Band 7	£884
Leather Group 1	POA



AD3
Skid Frame Stool
760mm Seat Height

Band 1	£498
Band 2	£510
Band 3	£536
Band 4	£555
Band 5	£580
Band 6	£603
Band 7	£625
Leather Group 1	POA



AD5
Skid Frame

Band 1	£603
Band 2	£625
Band 3	£667
Band 4	£703
Band 5	£739
Band 6	£781
Band 7	£819
Leather Group 1	POA



AD11
4 Star Base
(with Glides)

Band 1	£767
Band 2	£784
Band 3	£809
Band 4	£834
Band 5	£860
Band 6	£883
Band 7	£905
Leather Group 1	POA



AD12
4 Star Base
(with Castors)

Band 1	£782
Band 2	£798
Band 3	£825
Band 4	£849
Band 5	£872
Band 6	£897
Band 7	£920
Leather Group 1	POA



AD13
Pyramid Base
(with Glides)

Band 1	£854
Band 2	£869
Band 3	£896
Band 4	£919
Band 5	£945
Band 6	£967
Band 7	£992
Leather Group 1	POA



AD14
Pyramid Base
(with Castors)

Band 1	£866
Band 2	£884
Band 3	£911
Band 4	£934
Band 5	£960
Band 6	£982
Band 7	£1,006
Leather Group 1	£1,006

5 Year
Guarantee

ADORE

SOFT SEATING, RECEPTION & BREAKOUT



Camira Synergy Compose LDS72 (Band 3) with Chrome Pyramid Base

Reception,
Breakout &
Soft Seating

MOTILE

SOFT SEATING, RECEPTION & BREAKOUT



These compact lounge chairs are noted for their modern stylish appearance.

- Panelled form upholstery for added style.
- Offered in a number of frame options.

Base Colours



Product Features



Please Note

Available in selected fabrics only -
Please contact our Sales Department for further information.



MOTSF
Skid Frame

Band 1	£1,104
Band 2	£1,134
Band 3	£1,186
Band 4	£1,233
Band 5	£1,278
Band 6	£1,325
Band 7	£1,371
Leather Group 1	POA



MOT4BR
4 Star Base with Glides
and Auto Return

Band 1	£1,176
Band 2	£1,203
Band 3	£1,251
Band 4	£1,296
Band 5	£1,340
Band 6	£1,385
Band 7	£1,427
Leather Group 1	POA



Camira Synergy Affinity LDS74 (Band 3) Inner and Camira Rivet Forge EGL12 (Band 1) Outer with White Skid Frame

The LG30 Classic lounge chair offers the ultimate in style and comfort for waiting rooms, reception areas, hospitality and modern workspaces. With lacquered wooden legs and a durable upholstered shell in a range of fabric options, this soft seating option is a fresh alternative to conventional lounge or reception seating. The simple, clean silhouette of the LG30 Classic chair suits virtually any interior for a modern, updated look.

Product Features



Wood Colours



Ash



LG30AT
4 Leg Wooden Base
Tapered Leg

Band 1	£793
Band 2	£827
Band 3	£877
Band 4	£921
Band 5	£970
Band 6	£1,015
Band 7	£1,059



LG30HA
4 Leg Wooden Base
Tapered Leg

Band 1	£820
Band 2	£853
Band 3	£896
Band 4	£935
Band 5	£981
Band 6	£1,022
Band 7	£1,060



LG30ST
4 Leg Wooden Base
Tapered Leg

Band 1	£930
Band 2	£962
Band 3	£1,006
Band 4	£1,045
Band 5	£1,091
Band 6	£1,131
Band 7	£1,172



Gabriel Crisp 04432 Back and 04411 Seat (Band 4) (Red) Gabriel Crisp 04741 (Band 4) (Blue)

BETIBO

CONFERENCE, MEETING & CAFÉ SEATING



Gresham's new Betibo family of chairs. Designed for high-volume use, the Betibo family is perfect for use in conference rooms, cafes, or university meeting rooms where you have large groups of people to accommodate. Available as a standard-sized chair with or without arms, your guests will enjoy ultimate comfort during their visit. The Betibo family also includes a stool option that pairs perfectly with high tables such as our Deck, GD10 or GD1 Poseur brands to create a functional yet stylish work area. Alternatively, the stool will complement your breakfast bar or standing tables to create a relaxed environment for any hospitality area. Available in a variety of fabrics, our Betibo family of chairs will fit into your design scheme perfectly.

Product Features



Wooden Base Colours



TIB1
Chair with Wooden Legs

Band 1	£372
Band 2	£406
Band 3	£452
Band 4	£493
Band 5	£542
Band 6	£584
Band 7	£626
Leather Group 1	POA



TIB1A
Chair with Wooden Legs & Arm

Band 1	£463
Band 2	£496
Band 3	£545
Band 4	£584
Band 5	£633
Band 6	£675
Band 7	£718
Leather Group 1	POA



TIB2
Stool with Wooden Legs

Band 1	£498
Band 2	£517
Band 3	£545
Band 4	£567
Band 5	£594
Band 6	£617
Band 7	£641
Leather Group 1	POA



Reception,
Breakout &
Soft Seating

The LG10 combines a number of tactile materials to create a striking furniture piece. Its generously padded upholstery provides ultimate style and comfort. The innovative design incorporates a plastic frame which is available in both black and white. Combined with beech arms and exposed fixing details, this product is truly unique. LG10 was designed to suit a variety of interior spaces and to provide maximum visual impact.

Product Features



Frame Colours



White

Wood Arm Colours



Beech

Additional Information

Available in a variety of fabrics.



LG10A
1 Seater



LG10B
2 Seater

Band 1	£1,425
Band 2	£1,476
Band 3	£1,554
Band 4	£1,621
Band 5	£1,698
Band 6	£1,767
Band 7	£1,836

Band 1	£1,953
Band 2	£2,124
Band 3	£2,381
Band 4	£2,611
Band 5	£2,863
Band 6	£3,092
Band 7	£3,320



Panaz Linear 919 Zinc (Band 3)

OPSO

CONFERENCE, MEETING & CAFÉ SEATING



Opso Designed by Richard Jones

Introducing Opso, a brand new, innovative soft seating bench designed by Richard Jones. Renowned for his pared back, understated creations. This inverted triangular bench is visually eye-catching and will create a lasting impression; and with the accompanying table, it can be arranged into a myriad of configurations to suit any environment. Available in single or two tone fabrics with oak Texwood legs, the Opso offers an oasis of comfort within the workplace.

Product Features



Frame Colours



Oak
Texwood

Additional Information

Available in a variety of fabrics.



OP14BENSEAT
Upholstered Bench

Band 1	£1,702
Band 2	£1,753
Band 3	£1,820
Band 4	£1,881
Band 5	£1,953
Band 6	£2,016
Band 7	£2,078



Code	Description	Band 1	Band 2	Band 3	Band 4	Band 5	Band 6	Band 7
OP3WAYTAB	3 Way Linking Table	£1,034	£1,055	£1,082	£1,106	£1,136	£1,160	£1,186
OP4WAYTAB	4 Way Linking Table	£1,034	£1,055	£1,082	£1,106	£1,136	£1,160	£1,186



Reception,
Breakout &
Soft Seating

Opso Bench in AGUA Mystique Titan Midnight and AGUA Finezza Collection Ebony

5 Year
Guarantee

NEW
PRODUCT

OPSO

SOFT SEATING, RECEPTION & BREAKOUT



Reception,
Breakout &
Soft Seating

Opso Bench in AGUA Mystique Titan Midnight and AGUA Finezza Collection Ebony

GALLEN

SOFT SEATING, RECEPTION & BREAKOUT

5 Year Guarantee

A mix of comfort and style, Gallen combines a more traditional buttoned back cushion with a modern, contemporary shape.

- Large seat cushions for increased comfort.
- Tapered wooden legs.
- Mono seat and back cushions.
- Button detailing as standard.
- Available with optional fitted service modules
- Each module contains 1x UK power outlet and 1x twin USB fast charge outlet. Supplied with 3m lead to UK plug.
- Suffix code with 'P' to specify sofa with service module.

Leg Colours



Product Features



Optional Extras

2 & 3 Seater Service Module surcharge	£707
1 Seater Service Module surcharge	£391

1x USB-A
1x USB-C



TWIN USB
FAST CHARGE



GAL1H
1 Seater High Back

Band 1	£2,861
Band 2	£3,016
Band 3	£3,221
Band 4	£3,413
Band 5	£3,629
Band 6	£3,819
Band 7	£4,013



GAL2H
2 Seater High Back

Band 1	£3,718
Band 2	£3,974
Band 3	£4,310
Band 4	£4,631
Band 5	£4,987
Band 6	£5,304
Band 7	£5,619



GAL3H
3 Seater High Back

Band 1	£4,695
Band 2	£5,055
Band 3	£5,528
Band 4	£5,977
Band 5	£6,476
Band 6	£6,920
Band 7	£7,349



Camira Synergy Kindness LDS51 (Band 3) Sofa and Armchair with Camira Synergy Quilt Channel Serendipity QSC08 (Band 7) High Back with Black Wood Feet



GAL1
1 Seater With Arms

Band 1	£1,680
Band 2	£1,757
Band 3	£1,886
Band 4	£2,003
Band 5	£2,123
Band 6	£2,241
Band 7	£2,356
Leather Group 1	£2,445



GAL2
2 Seater With Arms

Band 1	£2,247
Band 2	£2,355
Band 3	£2,554
Band 4	£2,728
Band 5	£2,905
Band 6	£3,081
Band 7	£3,255
Leather Group 1	£3,559



GAL3
3 Seater With Arms

Band 1	£2,715
Band 2	£2,856
Band 3	£3,106
Band 4	£3,331
Band 5	£3,550
Band 6	£3,773
Band 7	£4,000
Leather Group 1	£4,292



GALC
Corner Unit

Band 1	£2,715
Band 2	£2,856
Band 3	£3,106
Band 4	£3,331
Band 5	£3,550
Band 6	£3,773
Band 7	£4,000
Leather Group 1	£4,292



Camira Synergy Guild LDS63 (Band 3) Armchair with Natural Wood Feet

GALLEN

SOFT SEATING, RECEPTION & BREAKOUT



GAL1R
1 Seater with R/Hand Arm

Band 1	£1,680
Band 2	£1,757
Band 3	£1,886
Band 4	£2,003
Band 5	£2,123
Band 6	£2,241
Band 7	£2,356
Leather Group 1	£2,445



GAL1L
1 Seater with L/Hand Arm

Band 1	£1,680
Band 2	£1,757
Band 3	£1,886
Band 4	£2,003
Band 5	£2,123
Band 6	£2,241
Band 7	£2,356
Leather Group 1	£2,445



GAL1X
1 Seater without Arms

Band 1	£1,680
Band 2	£1,757
Band 3	£1,886
Band 4	£2,003
Band 5	£2,123
Band 6	£2,241
Band 7	£2,356
Leather Group 1	£2,445



GAL2R
2 Seater with R/Hand Arm

Band 1	£2,247
Band 2	£2,355
Band 3	£2,554
Band 4	£2,728
Band 5	£2,905
Band 6	£3,081
Band 7	£3,255
Leather Group 1	£3,559



GAL2L
2 Seater with L/Hand Arm

Band 1	£2,247
Band 2	£2,355
Band 3	£2,554
Band 4	£2,728
Band 5	£2,905
Band 6	£3,081
Band 7	£3,255
Leather Group 1	£3,559



GAL2X
2 Seater without Arms

Band 1	£2,247
Band 2	£2,355
Band 3	£2,554
Band 4	£2,728
Band 5	£2,905
Band 6	£3,081
Band 7	£3,255
Leather Group 1	£3,559



Camira Blazer Silcoates CUZ30 (Band 4) Sofa & Cushion and Camira Xtreme Solano YS072 (Band 1) Cushion (Optional service modules shown)

Reception, Breakout & Soft Seating



GALLEN SOFT SEATING, RECEPTION & BREAKOUT



GAL3R
3 Seater with R/Hand Arm

Band 1	£2,715
Band 2	£2,856
Band 3	£3,106
Band 4	£3,331
Band 5	£3,550
Band 6	£3,773
Band 7	£4,000
Leather Group 1	£4,292



GAL3L
3 Seater with L/Hand Arm

Band 1	£2,715
Band 2	£2,856
Band 3	£3,106
Band 4	£3,331
Band 5	£3,550
Band 6	£3,773
Band 7	£4,000
Leather Group 1	£4,292



GAL3X
3 Seater without Arms

Band 1	£2,715
Band 2	£2,856
Band 3	£3,106
Band 4	£3,331
Band 5	£3,550
Band 6	£3,773
Band 7	£4,000
Leather Group 1	£4,292



Reception,
Breakout &
Soft Seating

Sofa & Button details Steel 911 Allure & Cushions Compose LDS72 Seat Cushions Compose LDS72

ALVIER WOODEN LEG

SOFT SEATING, RECEPTION & BREAKOUT



This elegant seating collection comprises of a single and two seat sofa with bench options.

- Solid wood frame construction.
- Accompanying coffee tables, available in a variety of top finishes.
- Perfect collection for breakout, reception, hotel lobby or executive office environments.

Frame Colours



Product Features



NS1BW
1 Seater
with Arms

Band 1	£1,492
Band 2	£1,531
Band 3	£1,612
Band 4	£1,633
Band 5	£1,744
Band 6	£1,815
Band 7	£1,881
Leather Group 1	POA



NS2BW
2 Seater
with Arms

Band 1	£2,136
Band 2	£2,200
Band 3	£2,322
Band 4	£2,428
Band 5	£2,536
Band 6	£2,642
Band 7	£2,753
Leather Group 1	POA



NS1HW
1 Seater Fixed Back Cushion
with Arms

Band 1	£1,717
Band 2	£1,772
Band 3	£1,876
Band 4	£1,965
Band 5	£2,053
Band 6	£2,142
Band 7	£2,233
Leather Group 1	POA



NS2HW
2 Seater Fixed Back Cushions
with Arms

Band 1	£2,587
Band 2	£2,676
Band 3	£2,842
Band 4	£2,986
Band 5	£3,132
Band 6	£3,278
Band 7	£3,423
Leather Group 1	POA



NS2PBW
2 Seater

Band 1	£2,136
Band 2	£2,200
Band 3	£2,322
Band 4	£2,428
Band 5	£2,536
Band 6	£2,642
Band 7	£2,748
Leather Group 1	POA



NS2PHW
2 Seater with Fixed Back
Cushions

Band 1	£2,587
Band 2	£2,676
Band 3	£2,842
Band 4	£2,986
Band 5	£3,132
Band 6	£3,278
Band 7	£3,423
Leather Group 1	POA



NS1W
Small Bench

Band 1	£935
Band 2	£962
Band 3	£1,007
Band 4	£1,050
Band 5	£1,088
Band 6	£1,129
Band 7	£1,171
Leather Group 1	POA



NS2W
2 Seater Large Bench

Band 1	£1,191
Band 2	£1,230
Band 3	£1,300
Band 4	£1,360
Band 5	£1,420
Band 6	£1,479
Band 7	£1,543
Leather Group 1	POA



NST069W
Table

980W x 680D x 275H	
Group Z	£566



NSCP
Loose Plain Cushion

Band 1	£128
Band 2	£138
Band 3	£147
Band 4	£157
Band 5	£165
Band 6	£174
Band 7	£186
Leather Group 1	POA



NSCB
Loose Piped and
Buttoned Cushion

Band 1	£150
Band 2	£157
Band 3	£168
Band 4	£177
Band 5	£187
Band 6	£198
Band 7	£205
Leather Group 1	POA

5 Year
Guarantee

ALVIER WOODEN LEG SOFT SEATING, RECEPTION & BREAKOUT



Reception,
Breakout &
Soft Seating

Kvadrat Steelcut Trio 3 0466 (Band 7) Outer and Kvadrat Steelcut Trio 3 0176 (Band 7) Inner

ALVIER SLED LEG

SOFT SEATING, RECEPTION & BREAKOUT



This elegant seating collection comprises of a single and two seat sofa with bench options.

- Stylish steel sled frame construction.
- Accompanying coffee tables, available in a variety of top finishes.
- Perfect collection for breakout, reception, hotel lobby or executive office environments.

Frame Colours

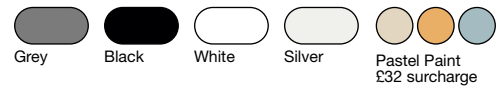

Product Features



NS1BS
1 Seater
with Arms

Band 1	£1,492
Band 2	£1,531
Band 3	£1,612
Band 4	£1,633
Band 5	£1,744
Band 6	£1,815
Band 7	£1,881
Leather Group 1	POA



NS2BS
2 Seater
with Arms

Band 1	£2,136
Band 2	£2,200
Band 3	£2,322
Band 4	£2,428
Band 5	£2,536
Band 6	£2,642
Band 7	£2,748
Leather Group 1	POA



NS1HS
1 Seater Fixed Back Cushion
with Arms

Band 1	£1,717
Band 2	£1,772
Band 3	£1,876
Band 4	£1,965
Band 5	£2,053
Band 6	£2,142
Band 7	£2,233
Leather Group 1	POA



NS2HS
2 Seater Fixed Back Cushions
with Arms

Band 1	£2,587
Band 2	£2,676
Band 3	£2,842
Band 4	£2,986
Band 5	£3,132
Band 6	£3,278
Band 7	£3,423
Leather Group 1	POA



NS2PBS
2 Seater

Band 1	£2,136
Band 2	£2,200
Band 3	£2,322
Band 4	£2,428
Band 5	£2,536
Band 6	£2,642
Band 7	£2,748
Leather Group 1	POA



NS2PHS
2 Seater with Fixed Back
Cushions

Band 1	£2,587
Band 2	£2,676
Band 3	£2,842
Band 4	£2,986
Band 5	£3,132
Band 6	£3,278
Band 7	£3,423
Leather Group 1	POA



NS1S
Small Bench

Band 1	£935
Band 2	£962
Band 3	£1,007
Band 4	£1,050
Band 5	£1,088
Band 6	£1,129
Band 7	£1,171
Leather Group 1	POA



NS2S
2 Seater Large Bench

Band 1	£1,191
Band 2	£1,230
Band 3	£1,300
Band 4	£1,360
Band 5	£1,420
Band 6	£1,479
Band 7	£1,543
Leather Group 1	POA



NST069S
Table
980W x 680D x 275H

Group Z	£566
---------------	------



NSCP
Loose Plain Cushion

Band 1	£128
Band 2	£138
Band 3	£147
Band 4	£157
Band 5	£165
Band 6	£174
Band 7	£186
Leather Group 1	POA



NSCB
Loose Piped and
Buttoned Cushion

Band 1	£150
Band 2	£157
Band 3	£168
Band 4	£177
Band 5	£187
Band 6	£198
Band 7	£205
Leather Group 1	POA

5 Year
Guarantee

ALVIER SLED LEG SOFT SEATING, RECEPTION & BREAKOUT

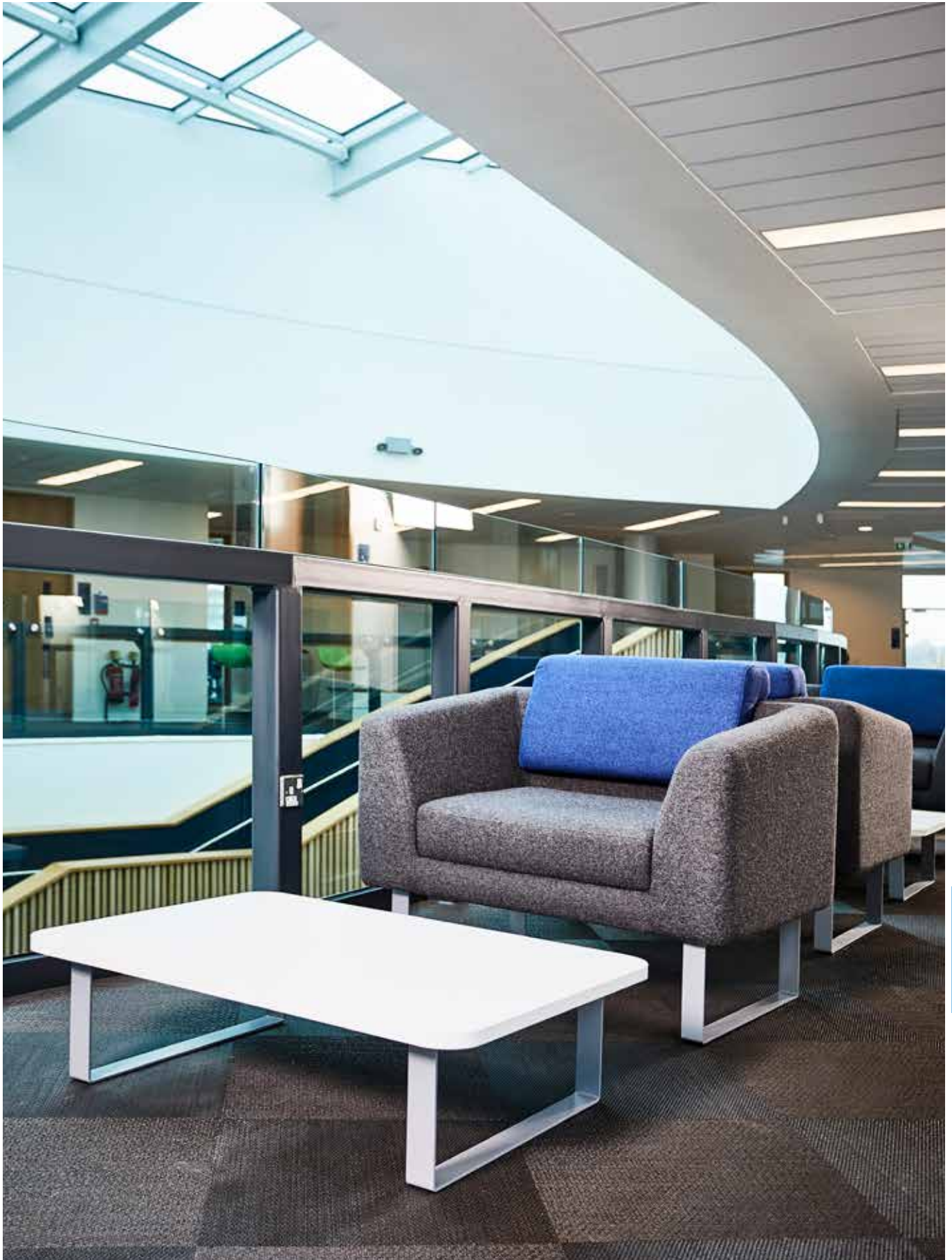

Reception,
Breakout &
Soft Seating

Camira X2 Number AK020 (Band 1) Outer and Camira X2 Maths AK007 (Band 1) Cushion with White Sled Leg

ALVIER TUBE LEG

SOFT SEATING, RECEPTION & BREAKOUT



This elegant seating collection comprises of a single and two seat sofa with bench options.

- Modern steel tube frame construction.
- Accompanying coffee tables, available in a variety of top finishes.
- Perfect collection for breakout, reception, hotel lobby or executive office environments.

Frame Colours

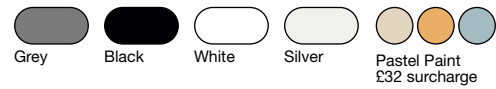

Product Features



NS1BM
1 Seater
with Arms

Band 1	£1,282
Band 2	£1,326
Band 3	£1,401
Band 4	£1,468
Band 5	£1,534
Band 6	£1,604
Band 7	£1,670
Leather Group 1.....	POA



NS2BM
2 Seater
with Arms

Band 1	£1,924
Band 2	£1,993
Band 3	£2,112
Band 4	£2,220
Band 5	£2,326
Band 6	£2,430
Band 7	£2,539
Leather Group 1.....	POA



NS1HM
1 Seater Fixed Back Cushion
with Arms

Band 1	£1,508
Band 2	£1,560
Band 3	£1,665
Band 4	£1,756
Band 5	£1,844
Band 6	£1,932
Band 7	£2,024
Leather Group 1.....	POA



NS2HM
2 Seater Fixed Back Cushions
with Arms

Band 1	£2,378
Band 2	£2,466
Band 3	£2,632
Band 4	£2,777
Band 5	£2,921
Band 6	£3,067
Band 7	£3,213
Leather Group 1.....	POA



NS2PBM
2 Seater

Band 1	£1,924
Band 2	£1,993
Band 3	£2,112
Band 4	£2,220
Band 5	£2,326
Band 6	£2,430
Band 7	£2,539
Leather Group 1.....	POA



NS2PHM
2 Seater with Fixed Back
Cushions

Band 1	£2,378
Band 2	£2,466
Band 3	£2,632
Band 4	£2,777
Band 5	£2,953
Band 6	£3,067
Band 7	£3,213
Leather Group 1.....	POA



NS1M
Small Bench

Band 1	£727
Band 2	£752
Band 3	£797
Band 4	£838
Band 5	£881
Band 6	£920
Band 7	£963
Leather Group 1.....	POA



NS2M
2 Seater Large Bench

Band 1	£982
Band 2	£1,022
Band 3	£1,088
Band 4	£1,149
Band 5	£1,211
Band 6	£1,270
Band 7	£1,332
Leather Group 1.....	POA



NST069M
Table

980w x 680d x 275h	
Group Z	£356



NSCP
Loose Plain Cushion

Band 1	£128
Band 2	£138
Band 3	£147
Band 4	£157
Band 5	£165
Band 6	£174
Band 7	£186
Leather Group 1.....	POA



NSCB
Loose Piped and Button
Cushion

Band 1	£150
Band 2	£157
Band 3	£168
Band 4	£177
Band 5	£187
Band 6	£198
Band 7	£205
Leather Group 1.....	POA

5 Year
Guarantee

ALVIER TUBE LEG SOFT SEATING, RECEPTION & BREAKOUT



Gabriel Atlantic 65075 (Band 3) with Silver Tube Legs

Reception,
Breakout &
Soft Seating

IZZEY

SOFT SEATING, RECEPTION & BREAKOUT

5 Year Guarantee

Redefining traditional high, winged back reading chairs, Izzey offers an inviting retreat for those seeking personal space. This armchair and sofa family is ideal for informal, discreet meetings or individual relaxation. Available with two back heights, in single and twin seat options that satisfies simple privacy requirements in open plan areas.

Frame Colours



Product Features



Please Note

Available in selected fabrics only - Please contact our Sales Department for further information.



IZH1
High Back Cut Out Arm 1 Seater

Band 4	£2,002
Band 5	£2,095
Band 6	£2,186
Band 7	£2,280
Leather Group 1	POA



IZH2
High Back Cut Out Arm 2 Seater

Band 4	£2,924
Band 5	£3,079
Band 6	£3,230
Band 7	£3,384
Leather Group 1	POA



IZLO1
Low Back Cut Out Arm 1 Seater

Band 4	£1,911
Band 5	£1,993
Band 6	£2,074
Band 7	£2,157
Leather Group 1	POA



IZLO2
Low Back Cut Out Arm 2 Seater

Band 4	£2,761
Band 5	£2,906
Band 6	£3,054
Band 7	£3,197
Leather Group 1	POA



IZH1FA
High Back Full Arm 1 Seater

Band 4	£2,002
Band 5	£2,095
Band 6	£2,186
Band 7	£2,280
Leather Group 1	POA



IZH2FA
High Back Full Arm 2 Seater

Band 4	£2,924
Band 5	£3,079
Band 6	£3,230
Band 7	£3,384
Leather Group 1	POA



IZLO1FA
Low Back Full Arm 1 Seater

Band 4	£1,911
Band 5	£1,993
Band 6	£2,074
Band 7	£2,157
Leather Group 1	POA



IZLO2FA
Low Back Full Arm 2 Seater

Band 4	£2,761
Band 5	£2,906
Band 6	£3,054
Band 7	£3,197
Leather Group 1	POA

5 Year
Guarantee

IZZEY

SOFT SEATING, RECEPTION & BREAKOUT



Reception,
Breakout &
Soft Seating

Camira X2 Number AK020 (Band 1) with Natural Wooden Legs

IZZHEY LITE

SOFT SEATING, RECEPTION & BREAKOUT



Izzy Lite is a playfully stylish chair that coordinates with the rest of this winged backed range. Where other family members create enclosed, personal space, 'Lite' encourages users to interact with the world around them. This compact tub chair is designed for relaxed, informal gatherings where small clusters can be arranged together. Perfect for contemporary socialising.

Product Features



Please Note

Available in selected fabrics only - Please contact our Sales Department for further information.



IZLT
Static

Band 3	£1,143
Band 4	£1,264
Band 5	£1,386
Band 6	£1,508
Band 7	£1,630
Leather Group 1	POA



IZLTS
Swivel

Band 3	£1,386
Band 4	£1,508
Band 5	£1,630
Band 6	£1,752
Band 7	£1,872
Leather Group 1	POA



IZLTW
Mobile

Band 3	£1,198
Band 4	£1,320
Band 5	£1,442
Band 6	£1,565
Band 7	£1,684
Leather Group 1	POA

5 Year
Guarantee

IZZHEY LITE

SOFT SEATING, RECEPTION & BREAKOUT

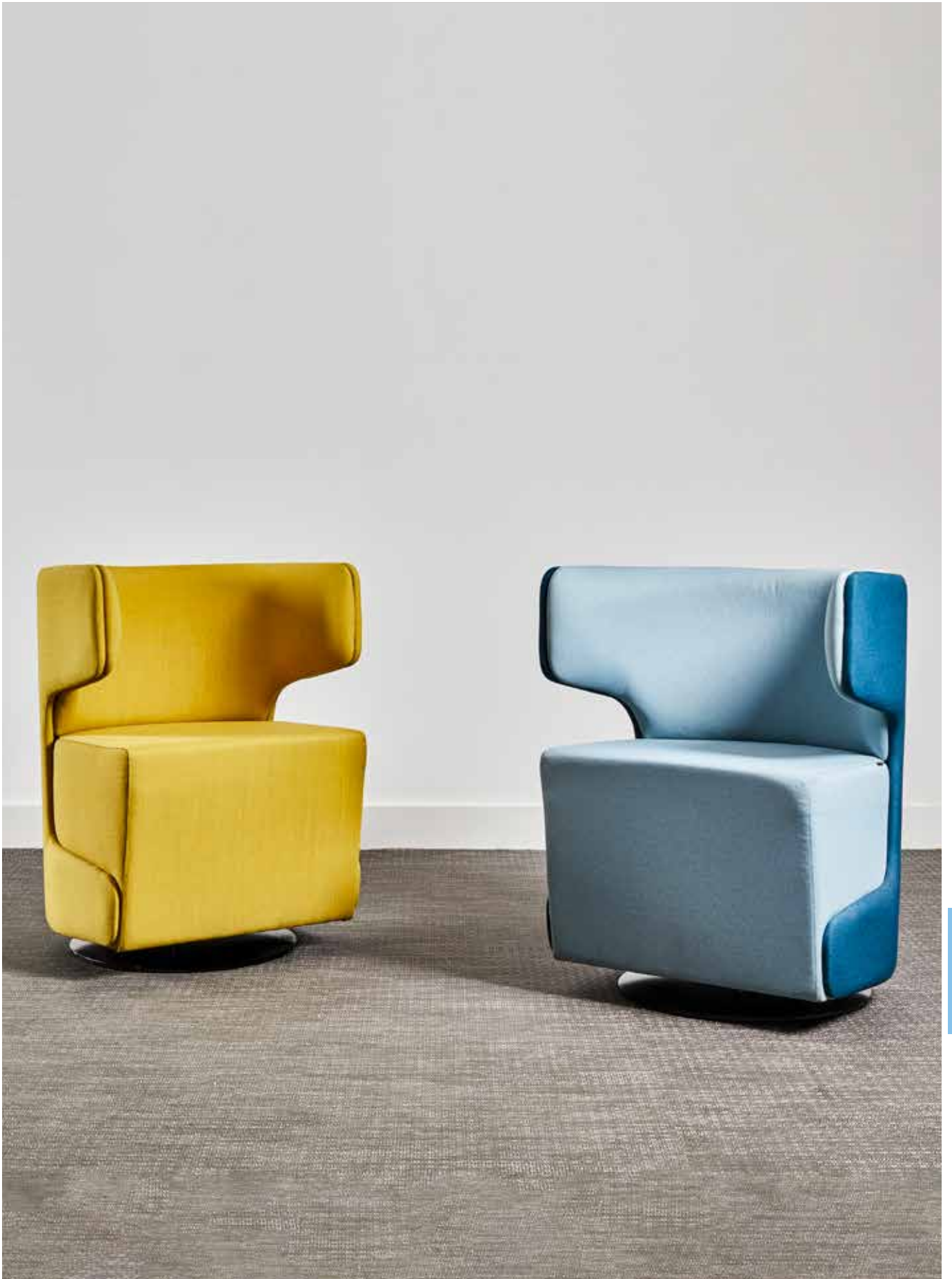

Reception,
Breakout &
Soft Seating

From L/R Gabriel Crisp 04211 (Band 4) and Gabriel Crisp 04751 (Band 4) Inner and Gabriel Crisp 04601 (Band 4) Outer with Swivel Base

TIROS

SOFT SEATING, RECEPTION & BREAKOUT



The perfect balance of form and function, our Tiros seating collection combines comfort with practicality. A cushioned back and base is complemented by the useful addition of an in-built table, just the right size for a laptop and a cup of coffee. Boasting a statement metal frame, which encases the cocoon-style seat within, the design - available in 4 variations: a high or low back single-seater and a high or low back two-seater - offering a chic solution for hospitality and workplace settings. The Tiros range is available with a Black, White, Grey or Silver Frame, and upholstered in a singular or two-tone fabric.

Product Features



Frame Colours



Optional Extra

Writing Tablet..... £201



TIR1LB
1 Seater Low Back

Band 1	£1,220
Band 2	£1,323
Band 3	£1,466
Band 4	£1,591
Band 5	£1,738
Band 6	£1,868
Band 7	£1,997



TIR1HB
1 Seater High Back

Band 1	£1,365
Band 2	£1,484
Band 3	£1,647
Band 4	£1,789
Band 5	£1,957
Band 6	£2,106
Band 7	£2,251



TIR2LB
2 Seater Low Back

Band 1	£1,656
Band 2	£1,797
Band 3	£1,990
Band 4	£2,159
Band 5	£2,359
Band 6	£2,537
Band 7	£2,710



TIR2HB
2 Seater High Back

Band 1	£1,879
Band 2	£2,037
Band 3	£2,256
Band 4	£2,447
Band 5	£2,673
Band 6	£2,873
Band 7	£3,069



Reception,
Breakout &
Soft Seating

5 Year
Guarantee

NEW
PRODUCT

TIROS

SOFT SEATING, RECEPTION & BREAKOUT



Reception,
Breakout &
Soft Seating

OSANA BENCH

SOFT SEATING, RECEPTION & BREAKOUT



A modern twist on classic aesthetics, our Osana Bench was created for collaboration. Equally, with some tweaks to its configuration, space can be made for solo work, relaxation or contemplation. Thanks to a sleek, understated design, Osana works well in workplace, residential and hospitality settings due to its ability to seamlessly complement its surroundings. Choose from either a Natural Oak or Dark Walnut finish for the frame, dialling up, or paring back on the statement.

Product Features



Frame Colours



Natural Ash



Dark Walnut



KB1SF
1 Seater Wooden Base

£351



KB2SF
2 Seater Wooden Base

£453



KB3SF
3 Seater Wooden Base

£539

KBBKT
Linking Bracket

£39





OSANA BENCH

SOFT SEATING, RECEPTION & BREAKOUT



KBCS
Seat with Arm and Back

Band 1	£745
Band 2	£786
Band 3	£844
Band 4	£895
Band 5	£953
Band 6	£1,007
Band 7	£1,058



KBSS
Seat with Back

Band 1	£653
Band 2	£687
Band 3	£736
Band 4	£778
Band 5	£828
Band 6	£873
Band 7	£916



KBPC
Seat Pad

Band 1	£483
Band 2	£503
Band 3	£532
Band 4	£557
Band 5	£586
Band 6	£613
Band 7	£639



KBTS
Table Top

£137



Reception,
Breakout &
Soft Seating

UNOA BOOTH

SOFT SEATING, RECEPTION & BREAKOUT



As the needs of the workplace have evolved over the last two-years, we, in turn, have adapted our product offering to include pieces such as the Unoa Booth. Allowing for small meetings to take place in a comfortable yet private setting, Unoa's acoustic properties are unparalleled for a solution of its size. The design also allows for inclusion of a monitor* for supporting presentations and video calls, which, thanks to the optimal acoustics of the booth, can be carried out with minimal disturbance to those working nearby. Choose from either a Natural Oak or Dark Walnut finish for Unoa's frame.

Product Features



Frame Colours



Natural Ash



Dark Walnut

*Monitor not included



UNOBA1
Half Booth without Table
Standard Upholstery

Band 1	£2,516
Band 2	£2,635
Band 3	£2,800
Band 4	£2,945
Band 5	£3,115
Band 6	£3,266
Band 7	£3,414



UNOBA2
Full Booth with Table
Standard Upholstery

Band 1	£6,894
Band 2	£7,199
Band 3	£7,618
Band 4	£7,988
Band 5	£8,421
Band 6	£8,806
Band 7	£9,184



Reception,
Breakout &
Soft Seating



UNOA BOOTH

SOFT SEATING, RECEPTION & BREAKOUT



Reception, Breakout & Soft Seating

TAKE UP

SOFT SEATING, RECEPTION & BREAKOUT

5 Year
Guarantee

Create your own environment with this acoustic, high-backed sofa system.

- Perfect whether needing privacy, wanting to socialise or function within a considered environment.
- Available in three height options, with and without arms.
- Associated tables and integrated technology available, Take Up works with you.

Product Features



Additional Information

Due to the nature of this product we advise use of fabrics from Band 3 and above (Please contact our sales department for further information) Table Tops available in all standard GOF MFC finishes. Integrated technology available.

Foot



Black
Glide



TAKE UP SOFT SEATING, RECEPTION & BREAKOUT



TKUMD
2 Tier
with Arms

Band 3	£2,589
Band 4	£2,750
Band 5	£2,909
Band 6	£3,068
Band 7	£3,226
Leather Group 1	POA



TKUML
2 Tier
with Left Arm

Band 3	£2,122
Band 4	£2,251
Band 5	£2,383
Band 6	£2,512
Band 7	£2,643
Leather Group 1	POA



TKUMR
2 Tier
with Right Arm

Band 3	£2,122
Band 4	£2,251
Band 5	£2,383
Band 6	£2,512
Band 7	£2,643
Leather Group 1	POA



TKUMS
2 Tier
without Arms

Band 3	£1,566
Band 4	£1,660
Band 5	£1,749
Band 6	£1,836
Band 7	£1,946
Leather Group 1	POA



TKUMST
2 Tier
with Table

Band 3	£1,566
Band 4	£1,660
Band 5	£1,749
Band 6	£1,836
Band 7	£1,946
Leather Group 1	POA



TKUMCA
2 Tier Corner

Band 3	£2,967
Band 4	£3,107
Band 5	£3,244
Band 6	£3,381
Band 7	£3,515
Leather Group 1	POA



TKUMCTA
2 Tier Corner
with Table

Band 3	£2,967
Band 4	£3,107
Band 5	£3,244
Band 6	£3,381
Band 7	£3,515
Leather Group 1	POA



TKUSD
Low Arm
with Arms

Band 3	£2,422
Band 4	£2,572
Band 5	£2,721
Band 6	£2,872
Band 7	£3,022
Leather Group 1	POA



TKUSL
Low Arm
with Left Arm

Band 3	£1,963
Band 4	£2,075
Band 5	£2,185
Band 6	£2,295
Band 7	£2,409
Leather Group 1	POA



TKUSR
Low Arm
with Right Arm

Band 3	£1,963
Band 4	£2,075
Band 5	£2,185
Band 6	£2,295
Band 7	£2,409
Leather Group 1	POA



TKUFD
Single Tier
with Arms

Band 3	£2,378
Band 4	£2,552
Band 5	£2,724
Band 6	£2,895
Band 7	£3,069
Leather Group 1	POA



TKUFL
Single Tier
with Left Arm

Band 3	£1,886
Band 4	£2,019
Band 5	£2,151
Band 6	£2,283
Band 7	£2,416
Leather Group 1	POA



TKUFR
Single Tier
with Right Arm

Band 3	£1,886
Band 4	£2,019
Band 5	£2,151
Band 6	£2,283
Band 7	£2,416
Leather Group 1	POA



TKUFS
Single Tier
without Arms

Band 3	£1,422
Band 4	£1,514
Band 5	£1,604
Band 6	£1,695
Band 7	£1,786
Leather Group 1	POA



TKUFST
Single Tier
with Table

Band 3	£1,422
Band 4	£1,514
Band 5	£1,604
Band 6	£1,695
Band 7	£1,786
Leather Group 1	POA



TKUFCA
Single Tier Corner

Band 3	£2,612
Band 4	£2,756
Band 5	£2,898
Band 6	£3,043
Band 7	£3,186
Leather Group 1	POA



TKUFCTA
Single Tier Corner
with Table

Band 3	£2,612
Band 4	£2,756
Band 5	£2,898
Band 6	£3,043
Band 7	£3,186
Leather Group 1	POA

TAKE UP

SOFT SEATING, RECEPTION & BREAKOUT



TKULD
3 Tier with Arms

Band 3	£3,085
Band 4	£3,307
Band 5	£3,531
Band 6	£3,754
Band 7	£3,975
Leather Group 1	POA



TKULL
3 Tier with Left Arm

Band 3	£2,490
Band 4	£2,651
Band 5	£2,814
Band 6	£2,976
Band 7	£3,138
Leather Group 1	POA



TKULR
3 Tier with Right Arm

Band 3	£2,490
Band 4	£2,651
Band 5	£2,814
Band 6	£2,976
Band 7	£3,138
Leather Group 1	POA



TKULS
3 Tier without Arms

Band 3	£1,760
Band 4	£1,866
Band 5	£1,975
Band 6	£2,079
Band 7	£2,186
Leather Group 1	POA



TKULST
3 Tier with Table

Band 3	£1,760
Band 4	£1,866
Band 5	£1,975
Band 6	£2,079
Band 7	£2,186
Leather Group 1	POA



TKULCA
3 Tier Corner

Band 3	£3,311
Band 4	£3,470
Band 5	£3,622
Band 6	£3,784
Band 7	£3,941
Leather Group 1	POA



TKULCTA
3 Tier Corner with Table

Band 3	£3,311
Band 4	£3,470
Band 5	£3,622
Band 6	£3,784
Band 7	£3,941
Leather Group 1	POA



Camira Blazer Silcoates CUZ30 (Band 4) Tier 1 and Outer with Camira Blazer Dunhurst CUZ58 (Band 4) Tier 2

TAKE UP SOFT SEATING, RECEPTION & BREAKOUT



TKUSCA
Scatter Cushion

Band 3	£113
Band 4	£129
Band 5	£147
Band 6	£164
Band 7	£179
Leather Group 1	POA



TKUCUS
Divider Arm

Band 3	£278
Band 4	£304
Band 5	£327
Band 6	£353
Band 7	£373
Leather Group 1	POA



TKUTOP
Divider table

Price	£174
-------------	------



TKU55
Single

Band 3	£494
Band 4	£539
Band 5	£586
Band 6	£635
Band 7	£677
Leather Group 1	POA



TKU58
Large Single

Band 3	£964
Band 4	£1,023
Band 5	£1,082
Band 6	£1,137
Band 7	£1,196
Leather Group 1	POA



TKU58T
Large Single Table

Band 3	£964
Band 4	£1,023
Band 5	£1,082
Band 6	£1,137
Band 7	£1,196
Leather Group 1	POA



TKU516
Double

Band 3	£1,373
Band 4	£1,470
Band 5	£1,566
Band 6	£1,665
Band 7	£1,761
Leather Group 1	POA



TKU516T
Large Double Table

Band 3	£1,373
Band 4	£1,470
Band 5	£1,566
Band 6	£1,665
Band 7	£1,761
Leather Group 1	POA



Camira Blazer Barnard CUZ2S (Band 4) Tier 1 and Outer with Camira Blazer Dartmouth CUZ2Q (Band 4) Tier 2

TAKE UP BOOTH

SOFT SEATING, RECEPTION & BREAKOUT



A variation of our high-back Take Up sofa system.

- Perfect for creating privacy and where audio visual communication may be required.
- Available for two or four users and in three height options.
- Associated table available with 25mm MFC top panel.

TV or Monitors are not included.

Optional Extras

TKBB Optional TV / Monitor Bracket £297
 For fitting to 1600 high and 1200 high connector walls.
 Can support up to 42" monitors (not supplied)

Additional Information

Due to the nature of this product we advise use of fabrics from Band 3 and above. We recommend that you request fabric samples prior to ordering. Two Tone Upholstery is available at a surcharge. Table Tops available in all standard GOF MFC finishes.

Product Features

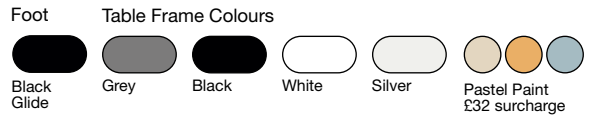

TKBL084
4 user, 3 tier, 1600mm high

Band 3	£13,771
Band 4	£14,856
Band 5	£15,578
Band 6	£16,304
Band 7	£17,025
Leather Group 1.....	POA



TKBL082
2 user, 3 tier, 1600mm high

Band 3	£8,792
Band 4	£9,550
Band 5	£9,951
Band 6	£10,348
Band 7	£10,750
Leather Group 1.....	POA



TKBL084T
4 user, 3 tier, 1600mm high with table

Band 3	£14,303
Band 4	£15,387
Band 5	£16,109
Band 6	£16,833
Band 7	£17,554
Leather Group 1.....	POA



TKBL082T
2 user, 3 tier, 1600mm high with table

Band 3	£9,264
Band 4	£10,023
Band 5	£10,424
Band 6	£10,820
Band 7	£11,220
Leather Group 1.....	POA



TKBM084
4 user, 2 tier, 1200mm high

Band 3	£11,420
Band 4	£12,322
Band 5	£12,920
Band 6	£13,522
Band 7	£14,123
Leather Group 1.....	POA



TKBM082
2 user, 2 tier, 1200mm high

Band 3	£7,179
Band 4	£7,816
Band 5	£8,159
Band 6	£8,497
Band 7	£8,837
Leather Group 1.....	POA



TKBM084T
4 user, 2 tier, 1200mm high with table

Band 3	£11,950
Band 4	£12,853
Band 5	£13,453
Band 6	£14,053
Band 7	£14,654
Leather Group 1.....	POA



TKBM082T
2 user, 2 tier, 1200mm high with table

Band 3	£7,652
Band 4	£8,288
Band 5	£8,630
Band 6	£8,968
Band 7	£9,307
Leather Group 1.....	POA

Reception, Breakout & Soft Seating

TAKE UP BOOTH

SOFT SEATING, RECEPTION & BREAKOUT

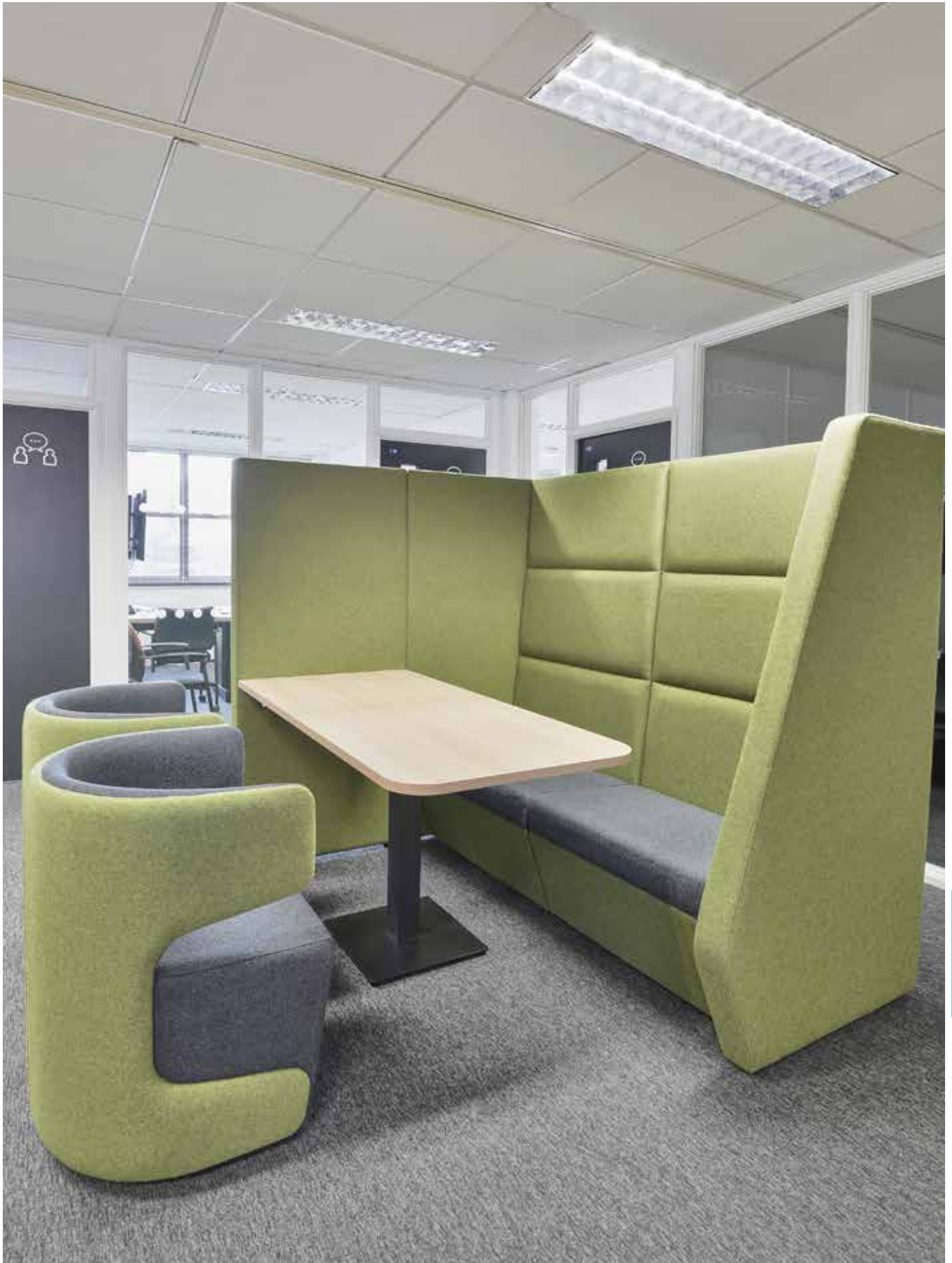

Camira (Band 4) Outer with Camira Blazer Camphill CUZ1K Seat Bromsgrove CUZ35

TAKE UP BOOTH

SOFT SEATING, RECEPTION & BREAKOUT



TKBL082TR
2 user, 3 tier, 1600mm high
with table (right hand)

Band 3	£9,596
Band 4	£10,083
Band 5	£10,485
Band 6	£10,882
Band 7	£11,281
Leather Group 1	POA



TKBL082TL
2 user, 3 tier, 1600mm high
with table (left hand)

Band 3	£9,596
Band 4	£10,083
Band 5	£10,485
Band 6	£10,882
Band 7	£11,281
Leather Group 1	POA



TKBL081TR
1 user, 3 tier, 1600mm high
with table (right hand)

Band 3	£6,773
Band 4	£7,370
Band 5	£7,609
Band 6	£7,843
Band 7	£8,084
Leather Group 1	POA



TKBL081TL
1 user, 3 tier, 1600mm high
with table (left hand)

Band 3	£6,773
Band 4	£7,370
Band 5	£7,609
Band 6	£7,843
Band 7	£8,084
Leather Group 1	POA



TKBM082TR
2 user, 2 tier, 1200mm high
with table (right hand)

Band 3	£7,710
Band 4	£8,349
Band 5	£8,689
Band 6	£9,030
Band 7	£9,369
Leather Group 1	POA



TKBM082TL
2 user, 2 tier, 1200mm high
with table (left hand)

Band 3	£7,710
Band 4	£8,349
Band 5	£8,689
Band 6	£9,030
Band 7	£9,369
Leather Group 1	POA



TKBM081TR
1 user, 2 tier, 1200mm high
with table (right hand)

Band 3	£5,531
Band 4	£6,038
Band 5	£6,249
Band 6	£6,454
Band 7	£6,663
Leather Group 1	POA



TKBM081TL
1 user, 2 tier, 1200mm high
with table (left hand)

Band 3	£5,531
Band 4	£6,038
Band 5	£6,249
Band 6	£6,454
Band 7	£6,663
Leather Group 1	POA



Reception, Breakout & Soft Seating

Camira Blazer Silcoates CUZ30 (Band 4) Tier 1 and Outer with Camira Blazer Dunhurst CUZ58 (Band 4) Tier 2 and 3

TAKE UP BOOTH

SOFT SEATING, RECEPTION & BREAKOUT



Camira (Band 3) Outer with Camira Synergy Engage LDS57 Seat Support LDS55 with White Framed White MFC Table

TAKE OFF

SOFT SEATING, RECEPTION & BREAKOUT



Take Off is a modular sofa system that can be used in reception or open plan work spaces where users need a 'time-out'.

- Available with and without backs or arms.
- Can be configured to delineate mid floor or perimeter space.
- Easily maintained upholstery and robust frame makes it ideal for heavy traffic areas.

Frame Colours

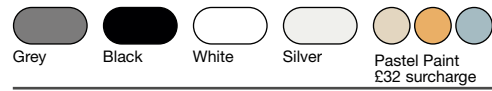

Product Features



Additional Information

Table Tops available in all standard GOF MFC finishes.



AS06LBA
Half Back with Left Arm

Band 1	£1,843
Band 2	£1,912
Band 3	£2,033
Band 4	£2,142
Band 5	£2,250
Band 6	£2,359
Band 7	£2,466
Leather Group 1	.POA



AS06RBA
Half Back with Right Arm

Band 1	£1,843
Band 2	£1,912
Band 3	£2,033
Band 4	£2,142
Band 5	£2,250
Band 6	£2,359
Band 7	£2,466
Leather Group 1	.POA



AS06FLA
Full Back with Left Arm

Band 1	£2,108
Band 2	£2,179
Band 3	£2,300
Band 4	£2,411
Band 5	£2,552
Band 6	£2,630
Band 7	£2,735
Leather Group 1	.POA



AS06FRA
Full Back with Right Arm

Band 1	£2,108
Band 2	£2,179
Band 3	£2,300
Band 4	£2,411
Band 5	£2,552
Band 6	£2,630
Band 7	£2,735
Leather Group 1	.POA



AS06FA
Full Back with Arms

Band 1	£2,395
Band 2	£2,483
Band 3	£2,641
Band 4	£2,780
Band 5	£2,920
Band 6	£3,061
Band 7	£3,200
Leather Group 1	.POA



AS06TB
2 Seater Twin Back

Band 1	£1,900
Band 2	£1,966
Band 3	£2,083
Band 4	£2,186
Band 5	£2,289
Band 6	£2,394
Band 7	£2,497
Leather Group 1	.POA



AS06LB
2 Seater Half Back L/H

Band 1	£1,558
Band 2	£1,602
Band 3	£1,679
Band 4	£1,753
Band 5	£1,820
Band 6	£1,891
Band 7	£1,963
Leather Group 1	.POA

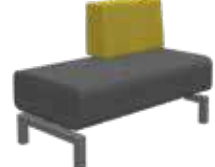

AS06RB
2 Seater Half Back R/H

Band 1	£1,558
Band 2	£1,602
Band 3	£1,679
Band 4	£1,753
Band 5	£1,820
Band 6	£1,891
Band 7	£1,963
Leather Group 1	.POA



AS06FB
Full Back 2 Seater

Band 1	£1,823
Band 2	£1,879
Band 3	£1,975
Band 4	£2,057
Band 5	£2,142
Band 6	£2,226
Band 7	£2,311
Leather Group 1	.POA



AS66FB
Full Back Single Seater

Band 1	£1,124
Band 2	£1,152
Band 3	£1,208
Band 4	£1,255
Band 5	£1,304
Band 6	£1,355
Band 7	£1,402
Leather Group 1	.POA



AS06
2 Seater without Back

Band 1	£1,022
Band 2	£1,041
Band 3	£1,084
Band 4	£1,120
Band 5	£1,157
Band 6	£1,191
Band 7	£1,228
Leather Group 1	.POA



AS66
Single Seater without Back

Band 1	£747
Band 2	£762
Band 3	£796
Band 4	£825
Band 5	£855
Band 6	£883
Band 7	£913
Leather Group 1	.POA

Reception, Breakout & Soft Seating

5 Year
Guarantee

TAKE OFF SOFT SEATING, RECEPTION & BREAKOUT



ASQ

Quadrant Seater without Back
Band 1£976
Band 2£998
Band 3£1,038
Band 4£1,075
Band 5£1,112
Band 6£1,147
Band 7£1,184
Leather Group 1POA



A1206Z
Rectangular
£666



A1212Z
Large Square
£765



A0606Z
Small Square
£504



ATQZ
Quadrant
£580



ATRZ
Radial
£679



Svensson VY 8200 (Band 6) (Grey Back) and Svensson Soft/Mill 8124 (Band 7) (Grey Seat) with Svensson VY 6636 (Band 6) (Yellow Seat) with Black Frame

Reception,
Breakout &
Soft Seating

TAKE OFF PLUS LOW BACK

SOFT SEATING, RECEPTION & BREAKOUT

5 Year Guarantee

Take Off Plus is an extension to our popular Take Off sofa system with the addition of stylised surrounds, integrated tables and technology.

Upholstered surrounds are available in two heights allowing Take Off Plus to blend collaborative working hubs with breakout spaces or quiet, concentration areas - making this distinctive family ideal for the modern workplace landscape where space is at a premium and multi-functionality is key.

The lower backed models are designed to coordinate with the higher models or for use on their own. These modules can be used equally effectively in open planned clusters, around the perimeter of a room or individually placed. The lower surrounds provide users with a feeling of security whilst allowing specifiers to inject two-toned colour options into their workspace.

Frame Options



Sled Frame
Suffix Code -K

Metal Colours

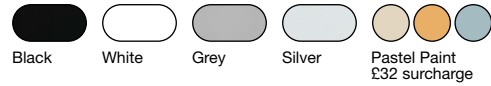

Camira X2 Subtract AK013 (Band 1) with Black Sled Frame

TAKE OFF PLUS LOW BACK SOFT SEATING, RECEPTION & BREAKOUT



TP3SL
1 Seater
Low Surround

Band 1	£2,265
Band 2	£2,363
Band 3	£2,508
Band 4	£2,639
Band 5	£2,782
Band 6	£2,914
Band 7	£3,040



TP3L
2 Seater
Low Surround

Band 1	£3,255
Band 2	£3,433
Band 3	£3,695
Band 4	£3,931
Band 5	£4,192
Band 6	£4,426
Band 7	£4,658



TP11L
3 Seater
Low Surround

Band 1	£3,717
Band 2	£4,033
Band 3	£4,500
Band 4	£4,926
Band 5	£5,394
Band 6	£5,817
Band 7	£6,234



TP4L
4 Seater
Low Surround

Band 1	£4,611
Band 2	£4,940
Band 3	£5,427
Band 4	£5,867
Band 5	£6,358
Band 6	£6,792
Band 7	£7,229



TP1L
Small Open Sym.
Low Surround

Band 1	£8,681
Band 2	£9,254
Band 3	£10,106
Band 4	£10,880
Band 5	£11,734
Band 6	£12,497
Band 7	£13,262



TP2LL
Large Corner L/H
Low Surround

Band 1	£8,979
Band 2	£9,604
Band 3	£10,536
Band 4	£11,381
Band 5	£12,314
Band 6	£13,147
Band 7	£13,981



TP2LR
Large Corner R/H
Low Surround

Band 1	£8,979
Band 2	£9,604
Band 3	£10,536
Band 4	£11,381
Band 5	£12,314
Band 6	£13,147
Band 7	£13,981



TP8L
Large Sym.
Low Surround

Band 1	£13,347
Band 2	£14,271
Band 3	£15,646
Band 4	£16,891
Band 5	£18,271
Band 6	£19,501
Band 7	£20,731



TP5L
Small Sym.
Low Surround

Band 1	£9,224
Band 2	£9,877
Band 3	£10,854
Band 4	£11,735
Band 5	£12,713
Band 6	£13,585
Band 7	£14,459



TP6LL
Small Corner L/H
Low Surround

Band 1	£6,918
Band 2	£7,409
Band 3	£8,142
Band 4	£8,801
Band 5	£9,535
Band 6	£10,190
Band 7	£10,843



TP6LR
Small Corner R/H
Low Surround

Band 1	£6,918
Band 2	£7,409
Band 3	£8,142
Band 4	£8,801
Band 5	£9,535
Band 6	£10,190
Band 7	£10,843



TP92TL
2 Seater with Table
Low Surround

Band 1	£6,185
Band 2	£6,393
Band 3	£6,665
Band 4	£6,990
Band 5	£7,280
Band 6	£7,655
Band 7	£8,030

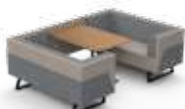

TP7TL
4 Seater with Table
Low Surround

Band 1	£7,442
Band 2	£7,796
Band 3	£8,324
Band 4	£8,801
Band 5	£9,331
Band 6	£9,803
Band 7	£10,275



TP106TL
6 Seater with Table
Low Surround

Band 1	£8,566
Band 2	£9,289
Band 3	£10,368
Band 4	£11,342
Band 5	£12,419
Band 6	£13,385
Band 7	£14,349

TAKE OFF PLUS HIGH BACK

SOFT SEATING, RECEPTION & BREAKOUT



Take Off Plus is an extension to our popular Take Off sofa system with the addition of stylised surrounds, integrated tables and technology.

Upholstered surrounds are available in two heights allowing Take Off Plus to blend collaborative working hubs with breakout spaces or quiet, concentration areas - making this distinctive family ideal for the modern workplace landscape where space is at a premium and multi-functionality is key.

The taller backed models within this family are set to the ideal height to offer privacy for users whilst allowing those around to see whether pods are occupied or not. They provide acoustic dampening when socialising or holding meetings in open-planned areas, without restricting existing lighting or air circulation within the room in which they are installed.

Take Off Plus Media Units have intergrated cable access behind TV mount and below table height.

Frame Options

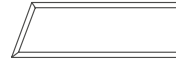

Sled Frame
Suffix Code -K

Metal Colours

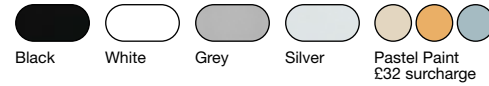

TP3SH
1 Seater
High Surround

Band 1	£3,085
Band 2	£3,264
Band 3	£3,533
Band 4	£3,775
Band 5	£4,042
Band 6	£4,281
Band 7	£4,524



TP3H
2 Seater
High Surround

Band 1	£3,735
Band 2	£3,978
Band 3	£4,342
Band 4	£4,671
Band 5	£5,033
Band 6	£5,360
Band 7	£5,682



TP11H
3 Seater
High Surround

Band 1	£4,619
Band 2	£4,961
Band 3	£5,471
Band 4	£5,928
Band 5	£6,437
Band 6	£6,893
Band 7	£7,348



TP4H
4 Seater
High Surround

Band 1	£5,309
Band 2	£5,664
Band 3	£6,192
Band 4	£6,670
Band 5	£7,199
Band 6	£7,673
Band 7	£8,145



High Back with White Sled Frame

TAKE OFF PLUS HIGH BACK SOFT SEATING, RECEPTION & BREAKOUT

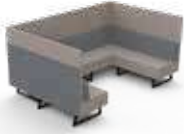

TP1H
Small Open Sym.
High Surround

Band 1	£9,809
Band 2	£10,428
Band 3	£11,353
Band 4	£12,189
Band 5	£13,113
Band 6	£13,939
Band 7	£14,765



TP2HL
Large Corner L/H
High Surround

Band 1	£10,123
Band 2	£10,802
Band 3	£11,816
Band 4	£12,732
Band 5	£13,746
Band 6	£14,653
Band 7	£15,559



TP2HR
Large Corner R/H
High Surround

Band 1	£10,123
Band 2	£10,802
Band 3	£11,816
Band 4	£12,732
Band 5	£13,746
Band 6	£14,653
Band 7	£15,559



TP8H
Large Sym.
High Surround

Band 1	£15,074
Band 2	£16,075
Band 3	£17,568
Band 4	£18,920
Band 5	£20,412
Band 6	£21,749
Band 7	£23,083

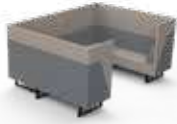

TP5H
Small Sym.
High Surround

Band 1	£10,372
Band 2	£11,079
Band 3	£12,136
Band 4	£13,093
Band 5	£14,151
Band 6	£15,097
Band 7	£16,044



TP6HL
Small Corner L/H
High Surround

Band 1	£7,771
Band 2	£8,303
Band 3	£9,095
Band 4	£9,812
Band 5	£10,605
Band 6	£11,315
Band 7	£12,024



TP6HR
Small Corner R/H
High Surround

Band 1	£7,771
Band 2	£8,303
Band 3	£9,095
Band 4	£9,812
Band 5	£10,605
Band 6	£11,315
Band 7	£12,024



TP7TH
4 Seater with Table
High Surround

Band 1	£10,254
Band 2	£10,800
Band 3	£11,614
Band 4	£12,349
Band 5	£13,162
Band 6	£13,888
Band 7	£14,616



TP92TH
2 Seater with Table
High Surround

Band 1	£7,593
Band 2	£8,035
Band 3	£8,548
Band 4	£9,170
Band 5	£9,703
Band 6	£10,405
Band 7	£11,108

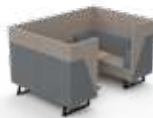

TP7TH
4 Seater with Table
High Surround

Band 1	£7,771
Band 2	£8,303
Band 3	£9,095
Band 4	£9,812
Band 5	£10,605
Band 6	£11,315
Band 7	£12,024



TP106TH
6 Seater with Table
High Surround

Band 1	£10,254
Band 2	£10,800
Band 3	£11,614
Band 4	£12,349
Band 5	£13,162
Band 6	£13,888
Band 7	£14,616



TP92TMH
2 Seater Media Unit
High Surround

Band 1	£7,708
Band 2	£8,150
Band 3	£8,663
Band 4	£9,285
Band 5	£9,818
Band 6	£10,520
Band 7	£11,108



TP94TMH
4 Seater Media Unit
High Surround

Band 1	£10,587
Band 2	£11,110
Band 3	£11,891
Band 4	£12,600
Band 5	£13,381
Band 6	£14,082
Band 7	£14,780



TP96TMH
6 Seater Media Unit
High Surround

Band 1	£12,744
Band 2	£13,518
Band 3	£14,675
Band 4	£15,722
Band 5	£16,880
Band 6	£17,912
Band 7	£18,946

TAKE OFF LITE

SOFT SEATING, RECEPTION & BREAKOUT



Take-Off Lite is a modular upholstered sofa system that can be used to delineate mid floor or perimeter spaces in those 'away-from-desk' areas, making it great for busy workplaces or public use.

Its seat and back can be matched, or complemented to provide additional visual interest, whilst Take-Off Lite's light-weight skid frame provides simple elegance whilst allowing modules to be easily configured to the desired layout.

Modules are available with or without backs, in single or twin seat options. Each unit can be matched to each other in any combination or used individually providing flexibility for your working landscape.

Frame Colours

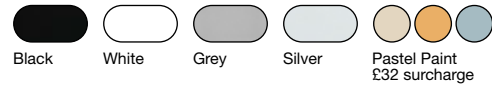

TL06
Single Seater with No Back

Band 1	£471
Band 2	£491
Band 3	£520
Band 4	£549
Band 5	£580
Band 6	£608
Band 7	£635



TL06FB
Single Seater with Full Back

Band 1	£625
Band 2	£660
Band 3	£710
Band 4	£756
Band 5	£806
Band 6	£855
Band 7	£898



TL12
2 Seater with No Back

Band 1	£676
Band 2	£702
Band 3	£739
Band 4	£775
Band 5	£815
Band 6	£849
Band 7	£883



TL12RB
2 Seater with
Right Hand Back

Band 1	£825
Band 2	£882
Band 3	£965
Band 4	£1,041
Band 5	£1,125
Band 6	£1,201
Band 7	£1,277



TL12FB
2 Seater with Full Back

Band 1	£901
Band 2	£970
Band 3	£1,074
Band 4	£1,165
Band 5	£1,268
Band 6	£1,359
Band 7	£1,448



TL12LB
2 Seater with
Left Hand Back

Band 1	£825
Band 2	£882
Band 3	£965
Band 4	£1,041
Band 5	£1,125
Band 6	£1,201
Band 7	£1,277



NST066S
Square Table

Group Z	£509
---------------	------



NST069S
Rectangular Table

Group Z	£566
---------------	------

5 Year
Guarantee

TAKE OFF LITE SOFT SEATING, RECEPTION & BREAKOUT



Reception,
Breakout &
Soft Seating

Camira Camira Patina Covered PAT14 Back Rest Camira Blazer Silverdale CUZ28 Seat with Grey Sled Frame

LS24

SOFT SEATING, RECEPTION & BREAKOUT

5 Year Guarantee

The LS24 is a timeless product that has been recently extended to include larger curved units. Reconfigurable and effective in a vast array of layouts, with a distinct design allowing for an imaginative use of fabric. Ideal for use in both small and large areas.

Product Features



Foot Colours



Additional Information

Available in a variety of fabrics.



LS24D1
Small Curve with Low Back

Band 1	£1,183
Band 2	£1,272
Band 3	£1,409
Band 4	£1,529
Band 5	£1,663
Band 6	£1,783
Band 7	£1,907



LS24D2
Small Curve with High Back

Band 1	£1,239
Band 2	£1,334
Band 3	£1,479
Band 4	£1,612
Band 5	£1,756
Band 6	£1,883
Band 7	£2,013



LS24E1
Large Curve with Low Back

Band 1	£2,207
Band 2	£2,328
Band 3	£2,512
Band 4	£2,677
Band 5	£2,860
Band 6	£3,024
Band 7	£3,225



LS24E2
Large Curve with High Back

Band 1	£2,231
Band 2	£2,365
Band 3	£2,563
Band 4	£2,745
Band 5	£2,942
Band 6	£3,120
Band 7	£3,300



From L/R Camira Blazer Stanford CUZ2R, Sheffield CUZ1T, Barlborough CUZ3D (Band 4) surrounded by Colorado Mirage Pod in Oxford CUZ09

LS24 SOFT SEATING, RECEPTION & BREAKOUT



LS24A1
1 Seater with Low Back

Band 1	£920
Band 2	£974
Band 3	£1,054
Band 4	£1,125
Band 5	£1,205
Band 6	£1,278
Band 7	£1,349



LS24A2
1 Seater with High Back

Band 1	£962
Band 2	£1,014
Band 3	£1,095
Band 4	£1,167
Band 5	£1,247
Band 6	£1,318
Band 7	£1,390



LS24B1
2 Seater with Low Back

Band 1	£1,491
Band 2	£1,570
Band 3	£1,694
Band 4	£1,804
Band 5	£1,924
Band 6	£2,034
Band 7	£2,143



LS24B2
2 Seater with High Back

Band 1	£1,532
Band 2	£1,620
Band 3	£1,749
Band 4	£1,865
Band 5	£1,993
Band 6	£2,108
Band 7	£2,222



LS24C1
3 Seater with Low Back

Band 1	£1,854
Band 2	£1,956
Band 3	£2,111
Band 4	£2,251
Band 5	£2,403
Band 6	£2,543
Band 7	£2,680



LS24C2
3 Seater with High Back

Band 1	£1,879
Band 2	£1,985
Band 3	£2,146
Band 4	£2,291
Band 5	£2,452
Band 6	£2,595
Band 7	£2,739



Kvadrat Canvas 2 0556 (Band 4) (Orange) and Kvadrat Canvas 2 0614 (Band 4) with White and Black Feet

KULTURE CAPALDI

SOFT SEATING, RECEPTION & BREAKOUT

5 Year
Guarantee

Kulture

Kulture Capaldi is an easily reconfigurable modular sofa designed specifically with the contract market in mind. The organically shaped rectangular units can be used individually, laid out in structured patterns or scattered throughout a space to create adaptable seating arrangements. The versatility of the design is endless, modules can be connected together in various ways, optimising soft seating in areas with space constraints in both public zones and private areas.

Product Features



Foot Colours



Black

Additional Information

Available in a variety of fabrics.

Example Configurations

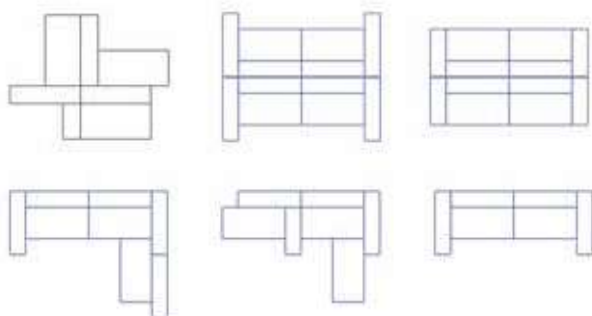

Typical Linking Configuration

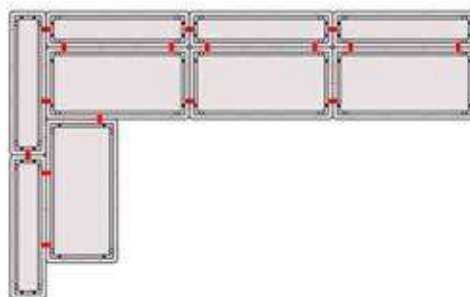

5 Year
Guarantee

KULTURE CAPALDI

SOFT SEATING, RECEPTION & BREAKOUT



KCSEAT
Seat Unit

W1180 x D590 x H440	
Band 1	£822
Band 2	£865
Band 3	£924
Band 4	£981
Band 5	£
1,041	
Band 6	£
1,097	
Band 7	£
1,152	



KCSEATING
Seat Unit

W1475 x D590 x H440	
Band 1	£895
Band 2	£937
Band 3	£996
Band 4	£1,053
Band 5	£1,115
Band 6	£1,170
Band 7	£1,224



KCBACK
Back Unit

W1180 x D295 x H762	
Band 1	£696
Band 2	£754
Band 3	£831
Band 4	£901
Band 5	£983
Band 6	£
1,055	
Band 7	£
1,126	



KCLINK
Linking Brackets

£116



KCLARM
Long Arm Unit

W885 x D295 x H630	
Band 1	£526
Band 2	£551
Band 3	£583
Band 4	£613
Band 5	£648
Band 6	£677
Band 7	£708



KCSARM
Short Arm Unit

W590 x D295 x H630	
Band 1	£478
Band 2	£504
Band 3	£536
Band 4	£567
Band 5	£600
Band 6	£631
Band 7	£661



Reception,
Breakout &
Soft Seating

NEOS

SOFT SEATING, RECEPTION & BREAKOUT



Available in Two-tone fabric and a choice of bases.

- Generous seat & back for added comfort.
- Four star bases fitted with gas lift mechanism, raising the chair from reception to work/dining height.
- Matching tables available.

R. Optional Auto Return Column available.
(Suffix code with R. Example: NPEPR)
Surcharge.....£13

T. Optional Tilt Mechanism available.
(Suffix code with T. Example: NPE4WT)
Surcharge.....£45

Frame Finishes

Metal

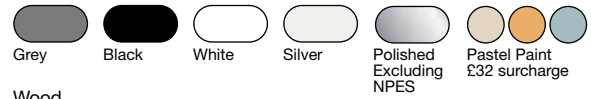

Wood



Product Features



NPES
Skid Frame

Band 1	£706
Band 2	£725
Band 3	£751
Band 4	£774
Band 5	£800
Band 6	£824
Band 7	£846
Leather Group 1	POA



NPE4W
Four Star Base
(With Castors)
T

Band 1	£754
Band 2	£769
Band 3	£795
Band 4	£820
Band 5	£845
Band 6	£870
Band 7	£895
Leather Group 1	POA



NPEP
Pyramid Base
(With Glides)
R

Band 1	£846
Band 2	£865
Band 3	£893
Band 4	£914
Band 5	£941
Band 6	£965
Band 7	£988
Leather Group 1	POA



NPEPW
Pyramid Base
(With Castors)
R

Band 1	£862
Band 2	£878
Band 3	£905
Band 4	£929
Band 5	£957
Band 6	£980
Band 7	£1,003
Leather Group 1	POA



Svensson Iconic 5553 (Band 5) with White Skid Frame

STRATT PLUS

SOFT SEATING, RECEPTION & BREAKOUT

Stratt Plus is a timeless product that has been recently extended to include larger curved units.

- Reconfigurable and effective in a vast array of configurations.
- Distinct design allows for an imaginative use of fabric.
- Ideal for use in both small and large areas.

Foot Colours



Product Features



STR1W
1 Seater with Wooden Leg

Band 1	£938
Band 2	£977
Band 3	£1,040
Band 4	£1,097
Band 5	£1,158
Band 6	£1,217
Band 7	£1,272
Leather Group 1	£1,925



STR2W
2 Seater with Wooden Leg

Band 1	£1,485
Band 2	£1,537
Band 3	£1,632
Band 4	£1,717
Band 5	£1,803
Band 6	£1,884
Band 7	£1,974
Leather Group 1	£2,742



STR3W
3 Seater with Wooden Leg

Band 1	£1,667
Band 2	£1,734
Band 3	£1,864
Band 4	£1,976
Band 5	£2,086
Band 6	£2,197
Band 7	£2,308
Leather Group 1	£3,343



R8CURPW
Small Curve 45°
with Wooden Leg

Band 1	£1,063
Band 2	£1,147
Band 3	£1,251
Band 4	£1,343
Band 5	£1,435
Band 6	£1,526
Band 7	£1,618
Leather Group 1	£2,079



R16CURPW
Large Curve with Wooden
Leg

Band 1	£2,013
Band 2	£2,094
Band 3	£2,238
Band 4	£2,365
Band 5	£2,493
Band 6	£2,619
Band 7	£2,750
Leather Group 1	£3,611

STR1M
1 Seater with Chrome Leg

Band 1	£1,142
Band 2	£1,180
Band 3	£1,243
Band 4	£1,301
Band 5	£1,360
Band 6	£1,416
Band 7	£1,474
Leather Group 1	£1,963

STR2M
2 Seater with Chrome Leg

Band 1	£1,686
Band 2	£1,737
Band 3	£1,834
Band 4	£1,919
Band 5	£2,002
Band 6	£2,089
Band 7	£2,172
Leather Group 1	£2,959

STR3M
3 Seater with Chrome Leg

Band 1	£1,871
Band 2	£1,940
Band 3	£2,064
Band 4	£2,177
Band 5	£2,287
Band 6	£2,397
Band 7	£2,510
Leather Group 1	£3,571

R8CURPM
Small Curve 45°
with Chrome Leg

Band 1	£1,287
Band 2	£1,345
Band 3	£1,450
Band 4	£1,543
Band 5	£1,632
Band 6	£1,724
Band 7	£1,817
Leather Group 1	£2,383

R16CURPM
Large Curve with Chrome
Leg

Band 1	£2,409
Band 2	£2,487
Band 3	£2,631
Band 4	£2,758
Band 5	£2,887
Band 6	£3,015
Band 7	£3,144
Leather Group 1	£3,915



Camira X2 Polygon AK002 (Band 1) Seat and Camira Synergy Team LDS21 (Band 3) Back with Chrome Leg

SOUND STATION

SOFT SEATING, RECEPTION & BREAKOUT

2 Year Guarantee

The Sound Station Chair is a multi-purpose piece, a sound cocoon, allowing the user a comfortable and uninterrupted experience whilst making phone calls or listening to music in the office or in public spaces. It is the first chair with built-in Apple AirPlay technology, also supporting Bluetooth connectivity to virtually any device containing music and audio books such as laptop, mp3 player, mobile phone, tablet computer or even TV or Apple TV system.

Base Options

Painted Plywood or Metal Powder-Coated Base

Audio Systems Options

Available on SST2.

BOSE: producer of superior, high-end loudspeakers, amplifiers and audio systems; renowned worldwide.

ADRAudio: known to few audio aficionados and many concert organizers, ADRAudio designs state-of-the-art loudspeakers and live audio systems for the world's most respected artists.



SST1
No Technology
Audiovisual Isolation
£7,784



SST2
Technology
Audiovisual Isolation /
Intergrated Sound System &
Receiver
£12,345



SSTPAD
iPad Holder
£1,045



SSTP
Foot Rest
£993

SOUND STATION FABRIC OPTIONS FAME BY GABRIEL



T 63016
B RAL 2001

T 64089
B RAL 3004

T 64168
B RAL 3022

T 65084
B RAL 5022

T 66075
B RAL 5013

T 66118
B RAL 5001

T 67016
B RAL 5020

T 68004
B RAL 6008

T 68035
B RAL 6020

T 68069
B RAL 6006



Gabriel Fame 68035

The Richmond sofa has been created as a blend of contemporary and traditional furniture. Its angular form is delicately rounded to help emphasise the comfort of the entire range.

- Deep seat cushions.
- Minimalist foot.
- Curved aesthetic.

Foot Colour



Product Features



RIC1
1 Seater

Band 1	£1,658
Band 2	£1,729
Band 3	£1,860
Band 4	£1,977
Band 5	£2,092
Band 6	£2,207
Band 7	£2,325
Leather Group 1	£2,421



RIC2
2 Seater

Band 1	£2,431
Band 2	£2,524
Band 3	£2,689
Band 4	£2,833
Band 5	£2,977
Band 6	£3,122
Band 7	£3,270
Leather Group 1	£3,513



RIC3
3 Seater

Band 1	£2,798
Band 2	£2,919
Band 3	£3,136
Band 4	£3,332
Band 5	£3,525
Band 6	£3,716
Band 7	£3,912
Leather Group 1	£4,151



Vescom Bowen 7030.17 (Band 6)

NAO

SOFT SEATING, RECEPTION & BREAKOUT

5 Year Guarantee

The Nao collection includes stand-alone units that can be grouped to create varied arrangements.

- Suitable for busy workplaces breakout zones as well as more relaxed soft seating spaces.
- Well proportioned design.
- Panel details for extra customisation.

Foot Colour

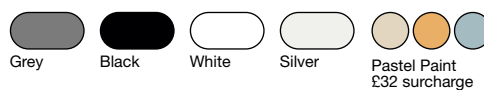

Product Features



NAO1
1 Seater

Band 1	£1,389
Band 2	£1,455
Band 3	£1,578
Band 4	£1,688
Band 5	£1,794
Band 6	£1,907
Band 7	£2,013
Leather Group 1	£2,486



NAO2
2 Seater

Band 1	£1,892
Band 2	£1,984
Band 3	£2,151
Band 4	£2,300
Band 5	£2,449
Band 6	£2,594
Band 7	£2,742
Leather Group 1	£3,311



NAO3
3 Seater

Band 1	£2,286
Band 2	£2,402
Band 3	£2,615
Band 4	£2,804
Band 5	£2,994
Band 6	£3,181
Band 7	£3,370
Leather Group 1	£4,015



Gabriel Fame 67067 (Band 4) Outer and Gabriel Fame 66133 (Band 4) Panel with Chrome Frame

CLAIRE SOFT SEATING, RECEPTION & BREAKOUT

Classic proportions, clean lines and sophisticated design, Claire provides an excellent sit with the added elegance of a stylish leg frame.

- Individual removable cushions.
- Piped Edges for added quality.
- Robust frame construction.

Frame Colours

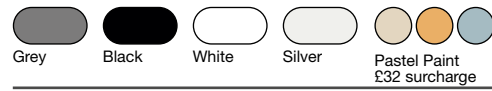

Product Features



Optional Extra

SCUSH Scatter Cushion (Band 1) £113



CY1
1 Seater

Band 1	£1,652
Band 2	£1,733
Band 3	£1,883
Band 4	£2,019
Band 5	£2,149
Band 6	£2,284
Band 7	£2,416
Leather Group 1	£2,739



CY2
2 Seater

Band 1	£2,472
Band 2	£2,585
Band 3	£2,789
Band 4	£2,970
Band 5	£3,151
Band 6	£3,334
Band 7	£3,513
Leather Group 1	£4,001



CY3
3 Seater

Band 1	£3,008
Band 2	£3,152
Band 3	£3,413
Band 4	£3,649
Band 5	£3,878
Band 6	£4,112
Band 7	£4,343
Leather Group 1	£4,988



Camira Aspect Malham ACT29 (Band 2) with Grey Frame

CHATTE

SOFT SEATING, RECEPTION & BREAKOUT

5 Year Guarantee

Sophistication and practicality best describe the Chatte collection.

- Timeless style.
- Available in single, two and three seater versions.
- Range of leg options.

Wooden Foot Colours



Product Features



Optional Extras



SCL Stiletto Chrome Leg
Price is surcharge to wooden leg price £61



CH1W
1 Seater with Wooden Legs

Band 1	£691
Band 2	£723
Band 3	£782
Band 4	£832
Band 5	£884
Band 6	£936
Band 7	£988
Leather Group 1	£1,313



CH2W
2 Seater with Wooden Legs

Band 1	£1,164
Band 2	£1,230
Band 3	£1,347
Band 4	£1,455
Band 5	£1,559
Band 6	£1,666
Band 7	£1,772
Leather Group 1	£2,298



CH3W
3 Seater with Wooden Legs

Band 1	£1,484
Band 2	£1,633
Band 3	£1,730
Band 4	£1,874
Band 5	£2,013
Band 6	£2,153
Band 7	£2,293
Leather Group 1	£2,920



CH1M
1 Seater with Chrome Legs

Band 1	£855
Band 2	£887
Band 3	£945
Band 4	£997
Band 5	£1,050
Band 6	£1,100
Band 7	£1,151
Leather Group 1	£1,489



CH2M
2 Seater with Chrome Legs

Band 1	£1,329
Band 2	£1,395
Band 3	£1,514
Band 4	£1,619
Band 5	£1,724
Band 6	£1,831
Band 7	£1,937
Leather Group 1	£2,466



CH3M
3 Seater with Chrome Legs

Band 1	£1,649
Band 2	£1,733
Band 3	£1,893
Band 4	£2,035
Band 5	£2,177
Band 6	£2,315
Band 7	£2,457
Leather Group 1	£3,090

5 Year
Guarantee

CHATTE

SOFT SEATING, RECEPTION & BREAKOUT



Reception,
Breakout &
Soft Seating

Camira X2 Subtract AK013 (Band 1) with Chrome Legs

OXY

SOFT SEATING, RECEPTION & BREAKOUT

5 Year Guarantee

Oxy is a sophisticated range that is at home in a number of interiors.

- Offered as a 2 and 3 seater sofa with matching arm chair.
- Stylish flared arm design.
- Single seat cushion.

Foot Colour



Chrome

Product Features



Optional Extras

SCUSH Scatter Cushion (Band 1)

£113



OXY1
1 Seater

Band 1	£891
Band 2	£935
Band 3	£1,020
Band 4	£1,088
Band 5	£1,161
Band 6	£1,234
Band 7	£1,305
Leather Group 1	£1,600



OXY2
2 Seater

Band 1	£1,253
Band 2	£1,325
Band 3	£1,446
Band 4	£1,555
Band 5	£1,662
Band 6	£1,772
Band 7	£1,880
Leather Group 1	£2,575



OXY3
3 Seater

Band 1	£1,589
Band 2	£1,688
Band 3	£1,865
Band 4	£2,023
Band 5	£2,180
Band 6	£2,336
Band 7	£2,493
Leather Group 1	£3,167



Camira Advantage Mineral AD010 (Band 1)

ATRIUM

SOFT SEATING, RECEPTION & BREAKOUT

Simple in shape, Atrium is easily reconfigurable making it ideal for busy workplaces as well as public use and educational spaces.

- Available with a choice of legs and in a wide variety of fabrics.

Foot Colours

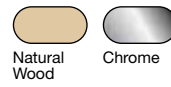

Product Features



ATF1W
1 Seater
Wooden Legs

Band 1	£564
Band 2	£591
Band 3	£641
Band 4	£690
Band 5	£734
Band 6	£782
Band 7	£827
Leather Group 1	£1,166



ATF2W
2 Seater
Wooden Legs

Band 1	£1,124
Band 2	£1,183
Band 3	£1,285
Band 4	£1,375
Band 5	£1,468
Band 6	£1,559
Band 7	£1,652
Leather Group 1	£2,330



ATF1
1 Seater
Chrome Legs

Band 1	£564
Band 2	£591
Band 3	£641
Band 4	£690
Band 5	£734
Band 6	£782
Band 7	£827
Leather Group 1	£1,166



ATF2
2 Seater
Chrome Legs

Band 1	£1,124
Band 2	£1,183
Band 3	£1,285
Band 4	£1,375
Band 5	£1,468
Band 6	£1,559
Band 7	£1,652
Leather Group 1	£2,330



Gabriel Atlantic 65037 (Band 3) Seat with Chrome Legs

OUTWOOD

SOFT SEATING, RECEPTION & BREAKOUT

5 Year Guarantee

Outwood is a modular range that is ideally suited for use in an array of different environments.

- Customisable and reconfigurable.
- Deep cushions add extra comfort.
- Outwood is the collection that fits around the user.

Foot



Black
Glide

Product Features



OR1
1 Seater

Band 1	£415
Band 2	£450
Band 3	£520
Band 4	£580
Band 5	£640
Band 6	£699
Band 7	£762
Leather Group 1	POA



ORA
1 Seater with Arms

Band 1	£769
Band 2	£827
Band 3	£927
Band 4	£1,020
Band 5	£1,106
Band 6	£1,196
Band 7	£1,285
Leather Group 1	POA



ORR
1 Seater with Right Arm

Band 1	£591
Band 2	£647
Band 3	£750
Band 4	£838
Band 5	£927
Band 6	£1,020
Band 7	£1,106
Leather Group 1	POA



ORL
1 Seater with Left Arm

Band 1	£591
Band 2	£647
Band 3	£750
Band 4	£838
Band 5	£927
Band 6	£1,020
Band 7	£1,106
Leather Group 1	POA



ORGT
Glass Top Table
750W x 750D x 440H

Band 1	£352
Band 2	£386
Band 3	£446
Band 4	£504
Band 5	£555
Band 6	£613
Band 7	£668
Leather Group 1	POA



ORMTR
Wood Top Table
750W x 750D x 440H

Band 1	£352
Band 2	£386
Band 3	£446
Band 4	£504
Band 5	£555
Band 6	£613
Band 7	£668
Leather Group 1	POA

5 Year
Guarantee

OUTWOOD

SOFT SEATING, RECEPTION & BREAKOUT



Reception,
Breakout &
Soft Seating

From L/R Camira Blazer Oriol CUZ18 (Band 4) and Camira Blazer Ulster CUZ1F (Band 4)

SOLENT

SOFT SEATING, RECEPTION & BREAKOUT

5 Year Guarantee

Solent is a visually distinctive offering that is based around the link between seat and back.

- Deep cushioned seat.
- Comfortable curved back.
- Perfect for use in a wide variety of environments such as touchdown, breakout, meeting spaces and waiting areas.
- Allows for an imaginative use of fabrics.
- Available with Wooden or Chrome foot.

Foot Colours

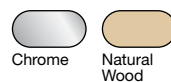

Product Features



	1 Seater	
	SOL1W Wooden Leg	SOL1M Chrome Leg
Band 1	£742.....	£919
Band 2	£789.....	£951
Band 3	£867.....	£1,031
Band 4	£937.....	£1,101
Band 5	£1,007.....	£1,171
Band 6	£1,081.....	£1,243
Band 7	£1,149.....	£1,312
Leather Group 1	£1,686.....	£1,881

	2 Seater	
	SOL2W Wooden Leg	SOL2M Chrome Leg
Band 1	£1,270.....	£1,433
Band 2	£1,352.....	£1,515
Band 3	£1,496.....	£1,660
Band 4	£1,626.....	£1,788
Band 5	£1,756.....	£1,917
Band 6	£1,883.....	£2,047
Band 7	£2,013.....	£2,176
Leather Group 1	£2,561.....	£2,792

	3 Seater	
	SOL3W Wooden Leg	SOL3M Chrome Leg
Band 1	£1,594.....	£1,759
Band 2	£1,713.....	£1,877
Band 3	£1,922.....	£2,089
Band 4	£2,109.....	£2,276
Band 5	£2,299.....	£2,462
Band 6	£2,487.....	£2,649
Band 7	£2,674.....	£2,837
Leather Group 1	£3,191.....	£3,399



Camira Halcyon Aspen Tigerlilly HPA11 (Band 3) Seat and Camira Halcyon Aspen Almond HPA10 (Band 3) with Chrome Feet

LYNSTOCK CHOICE RECEPTION

SOFT SEATING, RECEPTION & BREAKOUT

Lynstock Choice is ideal for waiting area or heavy-traffic environments that need a uniform look.

- Constructed with a welded steel frame.
- Generously upholstered foam back and seat panels which allows specifiers to match interior decors.
- Chairs are available with or without arms, left or right hand arm.

Product Features



Frame Colours

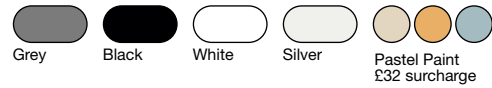

910
Chair

Band 1	£301
Band 2	£326
Band 3	£371
Band 4	£413
Band 5	£454
Band 6	£494
Band 7	£536
Leather Group 1	£625



910RM
Chair with Right Hand
Moulded Arm

Band 1	£331
Band 2	£360
Band 3	£406
Band 4	£445
Band 5	£486
Band 6	£529
Band 7	£571
Leather Group 1	£662



910LM
Chair with Left Hand
Moulded Arm

Band 1	£331
Band 2	£360
Band 3	£406
Band 4	£445
Band 5	£486
Band 6	£529
Band 7	£571
Leather Group 1	£662



910AM
Chair with Moulded Arms

Band 1	£367
Band 2	£393
Band 3	£438
Band 4	£478
Band 5	£522
Band 6	£564
Band 7	£606
Leather Group 1	£698



Bute Elgin Oxford CF667/0808 (Band 6) with Grey Frame

PENNINE

SOFT SEATING, RECEPTION & BREAKOUT

5 Year Guarantee

Pennine is the ideal choice for heavy-traffic environments that need the 'wood-frame' look.

- Laminated Beech frames provide strength and style.
- Cushioned upholstery allows specifiers to choose to match interior decors.
- Chairs are available with or without arms, left or right hand arm or stackable with matching reception tables.

Frame Colours



Beech

Product Features



XO1
4 Leg Half Back (Stackable)

Band 1	£280
Band 2	£290
Band 3	£322
Band 4	£341
Band 5	£364
Band 6	£386
Band 7	£408
Leather Group 1	£533



XO2
4 Leg Half Back with Arms (Stackable)

Band 1	£305
Band 2	£318
Band 3	£342
Band 4	£364
Band 5	£387
Band 6	£408
Band 7	£429
Leather Group 1	£554



XO3
4 Leg Full Back with Arms

Band 1	£370
Band 2	£392
Band 3	£429
Band 4	£465
Band 5	£498
Band 6	£533
Band 7	£567
Leather Group 1	£718



XO4
4 Leg Full Back

Band 1	£330
Band 2	£353
Band 3	£389
Band 4	£424
Band 5	£458
Band 6	£491
Band 7	£526
Leather Group 1	£668



Chieftain Just Colour Battleship Grey (Band 2)

Newton offers a timeless range of wood framed modular products that can be used collectively or individually.

- Welcoming wood finishes.
- Deep cushions for extra comfort.
- Ideal for residential surroundings where comfort and support is paramount.

Frame Colours



Beech

Product Features



651
Medium Back

Band 1	£572
Band 2	£595
Band 3	£641
Band 4	£687
Band 5	£727
Band 6	£765
Band 7	£806
Leather Group 1	POA



651A
Medium Back Armchair

Band 1	£635
Band 2	£660
Band 3	£703
Band 4	£742
Band 5	£784
Band 6	£824
Band 7	£863
Leather Group 1	POA



650A
High Back Armchair

Band 1	£710
Band 2	£735
Band 3	£784
Band 4	£824
Band 5	£866
Band 6	£905
Band 7	£948
Leather Group 1	POA



653T
Table 500W x 560D x 490H
Price

£401



Panaz Highland 226 Lime (Band 2)

CUBES & ARROWS

SOFT SEATING, RECEPTION & BREAKOUT

5 Year Guarantee

Easy to reconfigure in any breakout or touch down area, Cubes and Arrows tessellate to enable a range of contemporary shapes to be created.

- Available with a number of base options and in our vast range of fabrics.
- Cubes and Arrows lend themselves to large atrium areas as well as difficult to plan areas.

Product Features



Foot Colours



ES01
Cube Single Seat with Glides

Band 1	£311
Band 2	£332
Band 3	£372
Band 4	£411
Band 5	£446
Band 6	£483
Band 7	£519
Leather Group 1	£591



ES01M
Cube Single Seat with Metal Legs

Band 1	£411
Band 2	£433
Band 3	£474
Band 4	£510
Band 5	£546
Band 6	£583
Band 7	£618
Leather Group 1	£696



ES01C
Cube Single Seat with Castors

Band 1	£411
Band 2	£433
Band 3	£474
Band 4	£510
Band 5	£546
Band 6	£583
Band 7	£618
Leather Group 1	£696



AR1
Arrow Single Seat with Glides

Band 1	£490
Band 2	£511
Band 3	£552
Band 4	£588
Band 5	£626
Band 6	£662
Band 7	£697
Leather Group 1	£870



AR1M
Arrow Single Seat with Metal Legs

Band 1	£578
Band 2	£603
Band 3	£640
Band 4	£677
Band 5	£716
Band 6	£752
Band 7	£789
Leather Group 1	£957

5 Year
Guarantee

CUBES & ARROWS

SOFT SEATING, RECEPTION & BREAKOUT



Reception,
Breakout &
Soft Seating

Camira X2 Subtract AK013 (Band 1) with Glides

MOONS & ROUNDS

SOFT SEATING, RECEPTION & BREAKOUT

5 Year
Guarantee

The perfect match for any breakout or touch down area, Moons & Rounds nest together to provide a seamless blend of function and style.

- Simple to configure.
- Multiple options.
- Perfect for a number of different areas.

Product Features



Foot Colours

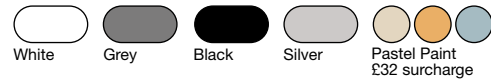

From L/R Svensson Accessoire River, Nest and Bok (Band 6) with Black Metal Legs

MOONS & ROUNDS

SOFT SEATING, RECEPTION & BREAKOUT



R500

Small Round with Glides

Band 1	£443
Band 2	£467
Band 3	£506
Band 4	£544
Band 5	£578
Band 6	£615
Band 7	£649
Leather Group 1	£870



R500M

Small Round with Metal Legs

Band 1	£544
Band 2	£566
Band 3	£605
Band 4	£637
Band 5	£670
Band 6	£703
Band 7	£737
Leather Group 1	£960



R500C

Small Round with Castors

Band 1	£544
Band 2	£566
Band 3	£605
Band 4	£637
Band 5	£670
Band 6	£703
Band 7	£737
Leather Group 1	£960



R800

Medium Round

Band 1	£674
Band 2	£709
Band 3	£769
Band 4	£827
Band 5	£882
Band 6	£937
Band 7	£993
Leather Group 1	£1,101



R800M

Medium Round with Chrome Legs

Band 1	£782
Band 2	£817
Band 3	£877
Band 4	£934
Band 5	£988
Band 6	£1,044
Band 7	£1,097
Leather Group 1	£1,205



R800C

Medium Round with Castors

Band 1	£782
Band 2	£817
Band 3	£877
Band 4	£934
Band 5	£988
Band 6	£1,044
Band 7	£1,097
Leather Group 1	£1,205



R1000

Large Round with Glides

Band 1	£890
Band 2	£928
Band 3	£1,002
Band 4	£1,065
Band 5	£1,132
Band 6	£1,197
Band 7	£1,224
Leather Group 1	£1,717



R1000M

Large Round with Metal Legs

Band 1	£988
Band 2	£1,027
Band 3	£1,102
Band 4	£1,166
Band 5	£1,233
Band 6	£1,299
Band 7	£1,363
Leather Group 1	£1,816



M500

Small Moon with Glides

Band 1	£468
Band 2	£490
Band 3	£531
Band 4	£568
Band 5	£605
Band 6	£639
Band 7	£675
Leather Group 1	£918



M500M

Small Moon with Metal Legs

Band 1	£568
Band 2	£587
Band 3	£629
Band 4	£661
Band 5	£694
Band 6	£729
Band 7	£762
Leather Group 1	£1,005



M500C

Small Moon with Castors

Band 1	£568
Band 2	£587
Band 3	£629
Band 4	£661
Band 5	£694
Band 6	£729
Band 7	£762
Leather Group 1	£1,005



M800

Medium Moon

Band 1	£754
Band 2	£767
Band 3	£853
Band 4	£906
Band 5	£963
Band 6	£1,023
Band 7	£1,074
Leather Group 1	£1,178



M800

Large Moon with Glides

Band 1	£936
Band 2	£977
Band 3	£1,053
Band 4	£1,116
Band 5	£1,183
Band 6	£1,245
Band 7	£1,311
Leather Group 1	£1,801



M800C

Large Moon with Metal Legs

Band 1	£1,035
Band 2	£1,075
Band 3	£1,149
Band 4	£1,216
Band 5	£1,281
Band 6	£1,344
Band 7	£1,410
Leather Group 1	£1,896



M1000

Medium Moon with Chrome Legs

Band 1	£855
Band 2	£891
Band 3	£951
Band 4	£1,007
Band 5	£1,060
Band 6	£1,118
Band 7	£1,173
Leather Group 1	£1,280



M1000M

Medium Moon with Castors

Band 1	£855
Band 2	£891
Band 3	£951
Band 4	£1,007
Band 5	£1,060
Band 6	£1,118
Band 7	£1,173
Leather Group 1	£1,280

CURVES, OVALS & RECTANGLES

SOFT SEATING, RECEPTION & BREAKOUT



When used alone, or when accompanying fellow products from the Cubes and Arrows collection, Curves and Ovals add a playful edge whereas Rectangles add practicality and space. These simple shapes can revitalise any reception, breakout or lounge area.

- Simple to configure.
- Multiple options.
- Perfect for a number of different areas.

Product Features



Foot Colours

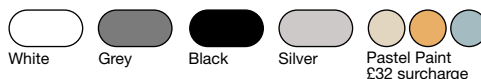

Additional Information

Available in a variety of fabrics.



EC2
2 Seater Curve with Glides

Band 1	£910
Band 2	£953
Band 3	£1,037
Band 4	£1,097
Band 5	£1,183
Band 6	£1,253
Band 7	£1,328
Leather Group 1	POA



EC2M
2 Seater Curve Metal Legs

Band 1	£1,064
Band 2	£1,102
Band 3	£1,171
Band 4	£1,232
Band 5	£1,295
Band 6	£1,352
Band 7	£1,413
Leather Group 1	POA



ER2
2 Seater Oval

Band 1	£709
Band 2	£765
Band 3	£866
Band 4	£954
Band 5	£1,044
Band 6	£1,135
Band 7	£1,223
Leather Group 1	POA



ER2M
2 Seater Oval with Metal Legs

Band 1	£867
Band 2	£904
Band 3	£1,022
Band 4	£1,111
Band 5	£1,201
Band 6	£1,291
Band 7	£1,380
Leather Group 1	POA



ES02
2 Seater Unit with Glides

Band 1	£583
Band 2	£616
Band 3	£676
Band 4	£731
Band 5	£784
Band 6	£837
Band 7	£891
Leather Group 1	£1,045



ES02M
2 Seater Unit with Metal Legs

Band 1	£738
Band 2	£771
Band 3	£834
Band 4	£887
Band 5	£938
Band 6	£993
Band 7	£1,045
Leather Group 1	£1,198

CURVES, OVALS & RECTANGLES

SOFT SEATING, RECEPTION & BREAKOUT



LS35

SOFT SEATING, RECEPTION & BREAKOUT



A developed version of Moons & Rounds brings the LS35 collection, a tapered silhouette with contrasting cushioned top.

Matching coffee tables and dining tables are also available to create an informal dining space or breakout area.

Product Features



Additional Information

Table tops available in all standard 25mm GOF MFC.



LS35A
Tapered Stool with Glides

Band 1	£411
Band 2	£434
Band 3	£464
Band 4	£491
Band 5	£522
Band 6	£550
Band 7	£577



LS35B
Low Table
385mm Coffee Height

Band 1	£353
Band 2	£371
Band 3	£395
Band 4	£421
Band 5	£445
Band 6	£469
Band 7	£491



LS35C
High Table
710mm Dining Height

Band 1	£640
Band 2	£664
Band 3	£693
Band 4	£721
Band 5	£752
Band 6	£779
Band 7	£806



Camira Blazer Silcoates CUZ30 (Band 4) Base and Camira Blazer Plymouth CUZ1R (Band 4) Top and White MFC

Doodh stands out from the rest with its beautifully angled legs. Sturdy yet light enough to move around easily, this strong and compact wooden stool and table collection is popular for use in breakout spaces, bars and cafés.

Specifying a hide top on the stool adds a quirky touch to any living space.

Product Features



Leg Colours



Additional Information

Table tops available in all standard 25mm GOF MFC or Laminate finishes. Laminate Tops are Under Chamfered.



NSST
3 Leg Wooden Stool

Band 1	£600
Band 2	£624
Band 3	£659
Band 4	£691
Band 5	£725
Band 6	£756
Band 7	£789
Leather/Hide.....	POA



NSCT
3 Leg Wooden Coffee Table

MFC Top.....	£550
Kiko Top.....	£690



INTRODUCTION

BEAM SEATING

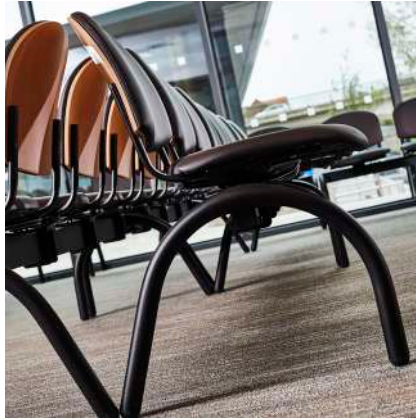



Items are available in a variety of fabrics. A number of products possess certain upholstery restrictions - these are therefore available in selected fabrics only and are identified within this brochure.

For further information regarding fabric suitability - Please contact our Sales Department



Arms are available on designated product ranges as indicated within the relevant product thumbnails. Colour / Finish options are indicated on relevant product pages - where applicable.

For further information regarding Arm options - Please contact our Sales Department.



Items include Reflex Foam Structure as standard.

Level 'S' tested to BS5459: Part 2: 2000.

Extreme Comfort.

Consistent Shape Retention.

Durability and long life.

Excellent Fire Retardant Properties.

We recommend that you request fabric samples prior to ordering.

Two tone upholstery is available on selected products.
Please contact our Sales Department for further information.

You can find dimensions for all products in the technical data section of this brochure.

Please Note: All images shown are for illustrative purposes.

Some aspects of certain products may differ.
Please contact our customer services department with any queries.

SJX BEAM BEAM SEATING



SJX Beam is the perfect seating solution for a variety of applications, with fully upholstered, mesh back and upholstered seat or plastic seat and back options and four coloured plastics. The shape of the seat back promotes good posture for long periods of sitting, preventing back ache. For areas with high traffic, alternative floor fixing end frames are offered to allow for units to be bolted to the floor for health and safety reasons. SJX Beam is available as two, three, four or five seats with table configurations.

Plastic Colours



Frame Colours

End frames available in Black.
Underframes are Black only.
Polished Chrome end frames
£153 surcharge.



-FF alternative floor fixing end frame (Black only)

Additional Information

Tables are available in any standard MFC wood finish and can be placed in any position, please specify at point of order. Position is as viewed from the front. When ordering please state position of arms as viewed from the front. Alternative floor fixing end frames are available (please suffix code with **-FF**).

Technical Data

Seat Height: 460mm; Height Over Arms 685mm

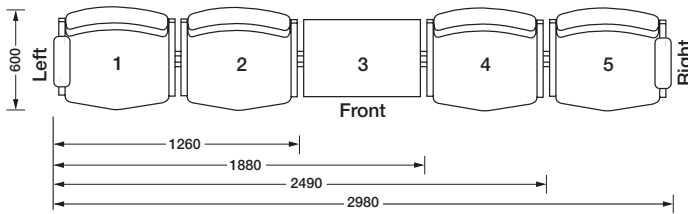

All dimensions are approximate and are for guidance only.

SJXB2SU 2 Seats Fully Upholstered	SJXB2STU 2 Seats/1 Table Fully Upholstered	SJXB3SU 3 Seats Fully Upholstered	SJXB3STU 3 Seats/1 Table Fully Upholstered	SJXB4SU 4 Seats Fully Upholstered
Band 1£752	Band 1£823	Band 1£1,017	Band 1£1,087	Band 1£1,287
Band 2£769	Band 2£842	Band 2£1,046	Band 2£1,120	Band 2£1,328
Band 3£808	Band 3£881	Band 3£1,102	Band 3£1,175	Band 3£1,402
Band 4£839	Band 4£913	Band 4£1,150	Band 4£1,224	Band 4£1,467
Band 5£872	Band 5£944	Band 5£1,199	Band 5£1,272	Band 5£1,533
Band 6£905	Band 6£980	Band 6£1,249	Band 6£1,320	Band 6£1,599
Band 7£937	Band 7£1,012	Band 7£1,296	Band 7£1,367	Band 7£1,662



SJX BEAM BEAM SEATING

2 Year
Guarantee

<p>SJXB4STU 4 Seats/ 1 Table Fully Upholstered</p> <p>Band 1£1,360 Band 2£1,397 Band 3£1,471 Band 4£1,535 Band 5£1,601 Band 6£1,667 Band 7£1,732</p>	<p>SJXB5SU 5 Seats Fully Upholstered</p> <p>Band 1£1,563 Band 2£1,614 Band 3£1,707 Band 4£1,788 Band 5£1,869 Band 6£1,951 Band 7£2,034</p>	<p>SJXB2SM 2 Seats Mesh Back/Upholstered Seat</p> <p>Band 1£752 Band 2£769 Band 3£808 Band 4£839 Band 5£872 Band 6£905 Band 7£937</p>	<p>SJXB2STM 2 Seats/1 Table Mesh Back/Upholstered Seat</p> <p>Band 1£823 Band 2£842 Band 3£881 Band 4£913 Band 5£944 Band 6£980 Band 7£1,012</p>	<p>SJXB3SM 3 Seats Mesh Back/Upholstered Seat</p> <p>Band 1£1,017 Band 2£1,046 Band 3£1,102 Band 4£1,150 Band 5£1,199 Band 6£1,249 Band 7£1,296</p>
<p>SJXB3STM 3 Seats/1 Table Mesh Back/Upholstered Seat</p> <p>Band 1£1,087 Band 2£1,120 Band 3£1,175 Band 4£1,224 Band 5£1,272 Band 6£1,320 Band 7£1,367</p>	<p>SJXB4SM 4 Seats Mesh Back/Upholstered Seat</p> <p>Band 1£1,287 Band 2£1,328 Band 3£1,402 Band 4£1,467 Band 5£1,533 Band 6£1,599 Band 7£1,662</p>	<p>SJXB4STM 4 Seats/ 1 Table Mesh Back/Upholstered Seat</p> <p>Band 1£1,360 Band 2£1,397 Band 3£1,471 Band 4£1,535 Band 5£1,601 Band 6£1,667 Band 7£1,732</p>	<p>SJXB5SM 5 Seats Mesh Back/Upholstered Seat</p> <p>Band 1£1,563 Band 2£1,614 Band 3£1,707 Band 4£1,788 Band 5£1,869 Band 6£1,951 Band 7£2,033</p>	<p>SJXB2SP 2 Seats Plastic Seat & Back</p> <p>Price£559</p>
<p>SJXB2STP 2 Seats/1 Table Plastic Seat & Back</p> <p>Price£630</p>	<p>SJXB3SP 3 Seats Plastic Seat & Back</p> <p>Price£747</p>	<p>SJXB3STP 3 Seats/1 Table Plastic Seat & Back</p> <p>Price£820</p>	<p>SJXB4SP 4 Seats Plastic Seat & Back</p> <p>Price£947</p>	<p>SJXB4STP 4 Seats/ 1 Table Plastic Seat & Back</p> <p>Price£1,018</p>
<p>SJXB5SP 5 Seats Plastic Seat & Back</p> <p>Price£1,143</p>	<p>SJXBARM Optional Black Moulded Arm (pair)</p> <p>Price£42</p>	<p>-FF Floor fixing end frame Surcharge per unit</p> <p>Price£59</p>		



ZELA BEAM BEAM SEATING



Zela Beam is a versatile and comfortable, modern polypropylene conference seat, which utilises the very latest moulding techniques, with fully upholstered, upholstered seat or plastic seat and back options, and the opportunity to choose from a selection of eight coloured plastics to personalise your space. This hard wearing, elegant and versatile, Beam Seating range is perfect for small reception areas, large waiting rooms and transport lounges. Zela Beam is available as two, three, four or five seats with table configurations.

Technical Data

Seat Height: 460mm; Height Over Arms 685mm

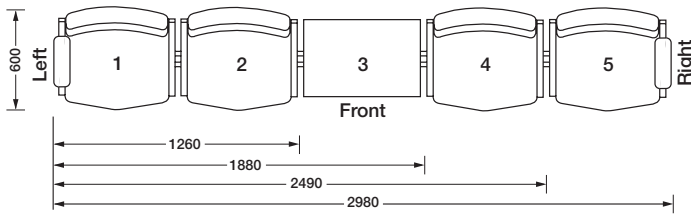

All dimensions are approximate and are for guidance only.

Plastic Colours

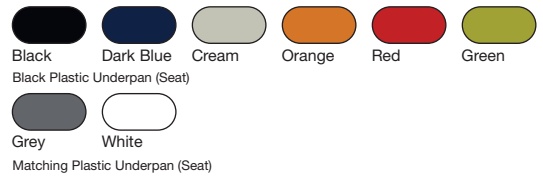

Frame Colours

End frames available in Black. Underframes are Black only. Polished Chrome end frames £153 surcharge.

Additional Information

Tables are available in any standard MFC wood finish and can be placed in any position, please specify at point of order. Position is as viewed from the front. Fully upholstered has a choice of Black, White or Grey shell. Underpan Black as standard except when White or Grey back plastics are used, which have matching underpans / Back Plastic (Un-upholstered) available in a choice of 8 colours. When ordering please state position of arms as viewed from the front.

ZLB2BP 2 Seats Fully Upholstered	ZLB2TBP 2 Seats/1 Table Fully Upholstered	ZLB3BP 3 Seats Fully Upholstered	ZLB3TBP 3 Seats/1 Table Fully Upholstered	ZLB4BP 4 Seats Fully Upholstered
Band 1£618	Band 1£742	Band 1£931	Band 1£1,053	Band 1£1,240
Band 2£637	Band 2£761	Band 2£958	Band 2£1,081	Band 2£1,277
Band 3£669	Band 3£794	Band 3£1,000	Band 3£1,126	Band 3£1,339
Band 4£698	Band 4£822	Band 4£1,044	Band 4£1,170	Band 4£1,393
Band 5£725	Band 5£850	Band 5£1,086	Band 5£1,209	Band 5£1,450
Band 6£754	Band 6£877	Band 6£1,128	Band 6£1,252	Band 6£1,504
Band 7£781	Band 7£905	Band 7£1,171	Band 7£1,294	Band 7£1,707



2 Year
Guarantee

ZELA BEAM BEAM SEATING

<p>ZLB4TBP 4 Seats/1 Table Fully Upholstered</p> <p>Band 1£1,363 Band 2£1,400 Band 3£1,462 Band 4£1,517 Band 5£1,572 Band 6£1,630 Band 7£1,686</p>	<p>ZLB5BP 5 Seats Fully Upholstered</p> <p>Band 1£1,550 Band 2£1,594 Band 3£1,670 Band 4£1,743 Band 5£1,812 Band 6£1,880 Band 7£1,952</p>	<p>ZLB2SP 2 Seats Plastic back/upholstered seat</p> <p>Band 1£572 Band 2£591 Band 3£622 Band 4£651 Band 5£678 Band 6£706 Band 7£734</p>	<p>ZLB2TSP 2 Seats/1 Table Plastic back/upholstered seat</p> <p>Band 1£698 Band 2£714 Band 3£747 Band 4£775 Band 5£804 Band 6£831 Band 7£858</p>	<p>ZLB3SP 3 Seats Plastic back/upholstered seat</p> <p>Band 1£860 Band 2£885 Band 3£934 Band 4£974 Band 5£1,017 Band 6£1,057 Band 7£1,101</p>
<p>ZLB3TSP 3 Seats/1 Table Plastic back/upholstered seat</p> <p>Band 1£984 Band 2£1,012 Band 3£1,055 Band 4£1,100 Band 5£1,142 Band 6£1,183 Band 7£1,224</p>	<p>ZLB4SP 4 Seats Plastic back/upholstered seat</p> <p>Band 1£1,146 Band 2£1,183 Band 3£1,245 Band 4£1,301 Band 5£1,356 Band 6£1,411 Band 7£1,467</p>	<p>ZLB4TSP 4 Seats/1 Table Plastic back/upholstered seat</p> <p>Band 1£1,272 Band 2£1,306 Band 3£1,367 Band 4£1,425 Band 5£1,483 Band 6£1,535 Band 7£1,593</p>	<p>ZLB5SP 5 Seats Plastic back/upholstered seat</p> <p>Band 1£1,434 Band 2£1,476 Band 3£1,556 Band 4£1,626 Band 5£1,695 Band 6£1,763 Band 7£1,837</p>	<p>ZLB2SX 2 Seats Plastic seat & back</p> <p>Price£529</p>
<p>ZLB2TSX 2 Seats/1 Table Plastic seat & back</p> <p>Price£651</p>	<p>ZLB3SX 3 Seats Plastic seat & back</p> <p>Price£792</p>	<p>ZLB3TSX 3 Seats/1 Table Plastic seat & back</p> <p>Price£914</p>	<p>ZLB4SX 4 Seats Plastic seat & back</p> <p>Price£1,053</p>	<p>ZLB4TSX 4 Seats/1 Table Plastic seat & back</p> <p>Price£1,178</p>
<p>ZLB5SX 5 Seats Plastic seat & back</p> <p>Price£1,317</p>	<p>ZLBARM Black Arm (each)</p> <p>Price£24</p>	<p>Polished Aluminium Arm surcharge (each)</p> <p>Price£46</p>		



JONQUIL BEAM

BEAM SEATING



Jonquil Beam applies itself to several environments. Ideal in a number of healthcare settings including public seating areas, waiting rooms, reception areas, corridors, doctor's surgeries and clinics. Choose from fully upholstered, beech veneer back with upholstered seat, beech veneer seat and back or plastic seat and back that's available in four colours. The seat and back design is generously contoured, and when upholstered with high-density foam, the padding provides good comfort during prolonged use. Jonquil Beam is available as two, three or four seats with table configurations.

Technical Data

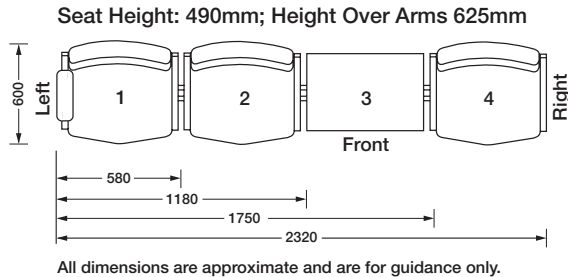

Plastic Colours



Frame Colours

End frames available in Black.
Underframes are Black only.
Polished Chrome end frames
£153 surcharge.

Additional Information

Tables are available in any standard MFC wood finish and can be placed in any position, please specify at point of order. Position is as viewed from the front. When ordering arms please state position as viewed from the front.

JONB2SU 2 Seats Fully Upholstered Chairs	JONB2STU 2 Seats / 1 Table Fully Upholstered Chairs	JONB3SU 3 Seats Fully Upholstered Chairs	JONB3STU 3 Seats / 1 Table Fully Upholstered Chairs	JONB4SU 4 Seats Fully Upholstered Chairs
Band 1£708	Band 1£828	Band 1£976	Band 1£1,094	Band 1£1,248
Band 2£727	Band 2£842	Band 2£1,000	Band 2£1,120	Band 2£1,284
Band 3£760	Band 3£878	Band 3£1,049	Band 3£1,168	Band 3£1,345
Band 4£789	Band 4£904	Band 4£1,089	Band 4£1,209	Band 4£1,401
Band 5£814	Band 5£933	Band 5£1,135	Band 5£1,252	Band 5£1,456
Band 6£842	Band 6£945	Band 6£1,175	Band 6£1,291	Band 6£1,511
Band 7£871	Band 7£987	Band 7£1,218	Band 7£1,334	Band 7£1,569
Leather Group 1 POA	Leather Group 1 POA	Leather Group 1 POA	Leather Group 1 POA	Leather Group 1 POA



2 Year
Guarantee

JONQUIL BEAM BEAM SEATING

JONB2SUV*
2 Seats
Beech Veneer
Upholstered Chairs

Band 1	£1,055
Band 2	£1,077
Band 3	£1,109
Band 4	£1,140
Band 5	£1,172
Band 6	£1,202
Band 7	£1,229
Leather Group 1	POA

JONB2STUV*
2 Seats / 1 Table
Beech Veneer
Upholstered Chairs

Band 1	£1,186
Band 2	£1,208
Band 3	£1,240
Band 4	£1,269
Band 5	£1,303
Band 6	£1,332
Band 7	£1,361
Leather Group 1	POA

JONB3SUV*
3 Seats
Beech Veneer
Upholstered Chairs

Band 1	£1,428
Band 2	£1,462
Band 3	£1,509
Band 4	£1,556
Band 5	£1,602
Band 6	£1,649
Band 7	£1,691
Leather Group 1	POA

JONB3STUV*
3 Seats / 1 Table
Beech Veneer
Upholstered Chairs

Band 1	£1,559
Band 2	£1,592
Band 3	£1,641
Band 4	£1,686
Band 5	£1,733
Band 6	£1,777
Band 7	£1,821
Leather Group 1	POA

JONB4SUV*
4 Seats
Beech Veneer
Upholstered Chairs

Band 1	£1,931
Band 2	£1,974
Band 3	£2,039
Band 4	£2,098
Band 5	£2,164
Band 6	£2,222
Band 7	£2,280
Leather Group 1	POA

JONB2SV
2 Seats
Beech Veneer Seat & Back

Price£754

JONB2STV
2 Seats / 1 Table
Beech Veneer Seat & Back

Price£884

JONB3SV
3 Seats
Beech Veneer Seat & Back

Price£1,014

JONB3STV
3 Seats / 1 Table
Beech Veneer Seat & Back

Price£1,145

JONB4SV
4 Seats
Beech Veneer Seat & Back

Price£1,374

JONB2SP
2 Seats
Plastic Seat & Back

Price£517

JONB2STP
2 Seats / 1 Table
Plastic Seat & Back

Price£636

JONB3SP
3 Seats
Plastic Seat & Back

Price£706

JONB3STP
3 Seats / 1 Table
Plastic Seat & Back

Price£825

JONB4SP
4 Seats
Plastic Seat & Back

Price£910

JONBARM
(each)
Arms - Black only

Price£22



ELSA TRIANGULAR BEAM BEAM SEATING



Elsa Beam is a premium and robust beam system that lends the design from our Heavy Duty chair range for a secure and comfortable waiting room row seat. The units are ideal for hospital and medical reception rooms, waiting areas and other public area environments. The fully upholstered CMHR foam back is offered in high, full and three-quarter size with a similarly upholstered seat for ultra-comfort for long periods of sitting. Elsa Beam is available as two, three or four seats with table configurations and a choice of a triangular frame or angular frame for a modern look and premium feel. Triangular end frames have pre-drilled holes for floor fixing.

Technical Data

Seat Height: 490mm; Height Over Arms 625mm

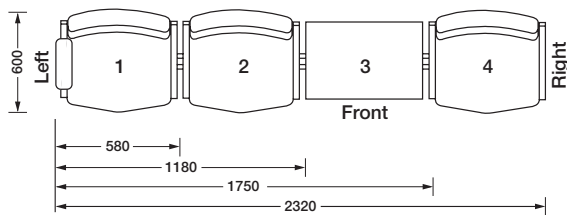

All dimensions are approximate and are for guidance only.

EHR2 2 Seats High Back		EHR2T 2 Seats/1 Table High Back		EHR3 3 Seats High Back		EHR3T 3 Seats/1 Table High Back		EHR4 4 Seats High Back	
Band 1	£794	Band 1	£910	Band 1	£1,132	Band 1	£1,278	Band 1	£1,500
Band 2	£839	Band 2	£956	Band 2	£1,203	Band 2	£1,346	Band 2	£1,595
Band 3	£924	Band 3	£1,040	Band 3	£1,328	Band 3	£1,471	Band 3	£1,762
Band 4	£997	Band 4	£1,114	Band 4	£1,438	Band 4	£1,585	Band 4	£1,911
Band 5	£1,073	Band 5	£1,187	Band 5	£1,552	Band 5	£1,695	Band 5	£2,062
Band 6	£1,146	Band 6	£1,262	Band 6	£1,662	Band 6	£1,808	Band 6	£2,211
Band 7	£1,222	Band 7	£1,335	Band 7	£1,775	Band 7	£1,920	Band 7	£2,359

Frame Colours

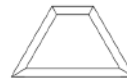
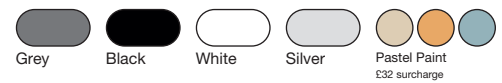

Additional Information

Tables are available in any standard MFC wood finish and can be placed in any position, please specify at point of order. Position is as viewed from the front.

When ordering arms please state position of as viewed from the front.

Optional Moulded Arm (each) £35



2 Year
Guarantee

ELSA TRIANGULAR BEAM BEAM SEATING

EFR2 2 Seats Full Back

Band 1	£761
Band 2	£808
Band 3	£892
Band 4	£965
Band 5	£1,041
Band 6	£1,115
Band 7	£1,188

EFR2T 2 Seats/1 Table Full Back

Band 1	£875
Band 2	£922
Band 3	£1,006
Band 4	£1,080
Band 5	£1,155
Band 6	£1,228
Band 7	£1,303

EFR3 3 Seats Full Back

Band 1	£1,082
Band 2	£1,151
Band 3	£1,280
Band 4	£1,390
Band 5	£1,500
Band 6	£1,612
Band 7	£1,724

EFR3T 3 Seats/1 Table Full Back

Band 1	£1,227
Band 2	£1,296
Band 3	£1,424
Band 4	£1,533
Band 5	£1,647
Band 6	£1,758
Band 7	£1,871

EFR4 4 Seats Full Back

Band 1	£1,434
Band 2	£1,529
Band 3	£1,696
Band 4	£1,846
Band 5	£1,996
Band 6	£2,143
Band 7	£2,294

EQR2 2 Seats 3/4 Back

Band 1	£660
Band 2	£689
Band 3	£736
Band 4	£779
Band 5	£824
Band 6	£867
Band 7	£912

EQR2T 2 Seats/1 Table 3/4 Back

Band 1	£795
Band 2	£823
Band 3	£872
Band 4	£915
Band 5	£960
Band 6	£1,005
Band 7	£1,046

EQR3 3 Seats 3/4 Back

Band 1	£892
Band 2	£933
Band 3	£1,007
Band 4	£1,073
Band 5	£1,140
Band 6	£1,204
Band 7	£1,268

EQR3T 3 Seats/1 Table 3/4 Back

Band 1	£1,024
Band 2	£1,068
Band 3	£1,142
Band 4	£1,207
Band 5	£1,273
Band 6	£1,339
Band 7	£1,403

EQR4 4 Seats 3/4 Back

Band 1	£1,120
Band 2	£1,176
Band 3	£1,274
Band 4	£1,362
Band 5	£1,450
Band 6	£1,535
Band 7	£1,626



ELSA ANGULAR BEAM BEAM SEATING



Elsa Beam is a premium and robust beam system that lends the design from our Heavy Duty chair range for a secure and comfortable waiting room row seat. The units are ideal for hospital and medical reception rooms, waiting areas and other public area environments. The fully upholstered CMHR foam back is offered in high, full and three-quarter size with a similarly upholstered seat for ultra-comfort for long periods of sitting. Elsa Beam is available as two, three or four seats with table configurations and a choice of a triangular frame or angular frame for a modern look and premium feel.

Technical Data

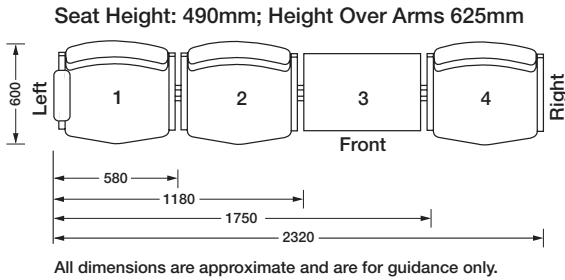

EHA2 2 Seats High Back	
Band 1	£794
Band 2	£839
Band 3	£924
Band 4	£997
Band 5	£1,073
Band 6	£1,146
Band 7	£1,222

EHA2T 2 Seats/1 Table High Back	
Band 1	£910
Band 2	£956
Band 3	£1,040
Band 4	£1,114
Band 5	£1,187
Band 6	£1,262
Band 7	£1,335

EHA3 3 Seats High Back	
Band 1	£1,132
Band 2	£1,203
Band 3	£1,328
Band 4	£1,438
Band 5	£1,552
Band 6	£1,662
Band 7	£1,775

EHA3T 3 Seats/1 Table High Back	
Band 1	£1,278
Band 2	£1,346
Band 3	£1,471
Band 4	£1,585
Band 5	£1,695
Band 6	£1,808
Band 7	£1,920

EHA4 4 Seats High Back	
Band 1	£1,500
Band 2	£1,595
Band 3	£1,762
Band 4	£1,911
Band 5	£2,062
Band 6	£2,211
Band 7	£2,359



Frame Colours

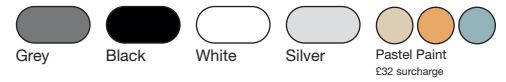

Additional Information

Tables are available in any standard MFC wood finish and can be placed in any position, please specify at point of order. Position is as viewed from the front.

When ordering arms please state position of as viewed from the front.

Optional Moulded Arm (each) £35



2 Year
Guarantee

ELSA ANGULAR BEAM BEAM SEATING

EFA2 2 Seats Full Back

Band 1	£761
Band 2	£808
Band 3	£892
Band 4	£965
Band 5	£1,041
Band 6	£1,115
Band 7	£1,188

EFA2T 2 Seats/1 Table Full Back

Band 1	£875
Band 2	£922
Band 3	£1,006
Band 4	£1,080
Band 5	£1,155
Band 6	£1,228
Band 7	£1,303

EFA3 3 Seats Full Back

Band 1	£1,082
Band 2	£1,151
Band 3	£1,280
Band 4	£1,390
Band 5	£1,500
Band 6	£1,612
Band 7	£1,724

EFA3T 3 Seats/1 Table Full Back

Band 1	£1,227
Band 2	£1,296
Band 3	£1,424
Band 4	£1,533
Band 5	£1,647
Band 6	£1,758
Band 7	£1,871

EFA4 4 Seats Full Back

Band 1	£1,434
Band 2	£1,529
Band 3	£1,696
Band 4	£1,846
Band 5	£1,996
Band 6	£2,143
Band 7	£2,294

EQA2 2 Seats 3/4 Back

Band 1	£660
Band 2	£689
Band 3	£736
Band 4	£779
Band 5	£824
Band 6	£867
Band 7	£912

EQA2T 2 Seats/1 Table 3/4 Back

Band 1	£795
Band 2	£823
Band 3	£872
Band 4	£915
Band 5	£960
Band 6	£1,005
Band 7	£1,046

EQA3 3 Seats 3/4 Back

Band 1	£892
Band 2	£933
Band 3	£1,007
Band 4	£1,073
Band 5	£1,140
Band 6	£1,204
Band 7	£1,268

EQA3T 3 Seats/1 Table 3/4 Back

Band 1	£1,024
Band 2	£1,068
Band 3	£1,142
Band 4	£1,207
Band 5	£1,273
Band 6	£1,339
Band 7	£1,403

EQA4 4 Seats 3/4 Back

Band 1	£1,120
Band 2	£1,176
Band 3	£1,274
Band 4	£1,362
Band 5	£1,450
Band 6	£1,535
Band 7	£1,626



NOTE BEAM BEAM SEATING



- A range of Beam Seating complementing our Note Chair Collection.
- Available in various configurations.

Plastic Colours



Frame Colours



Additional Information

Tables are available in any standard MFC wood finish and can be placed in any position, please specify at point of order. Position is as viewed from the front.

Technical Data

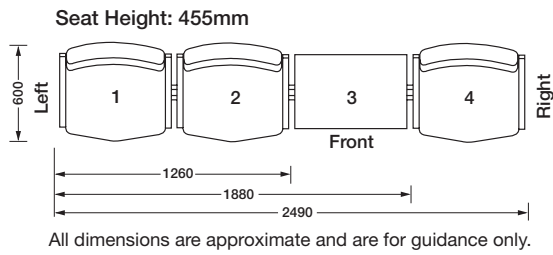

FB2S 2 Seats	FB2ST 2 Seats/1 Table	FB3S 3 Seats	FB3ST 3 Seats/1 Table	FB4S 4 Seats
Price£670	Price£796	Price£855	Price£980	Price..£1,039



NOTE BEAM BEAM SEATING

2 Year
Guarantee

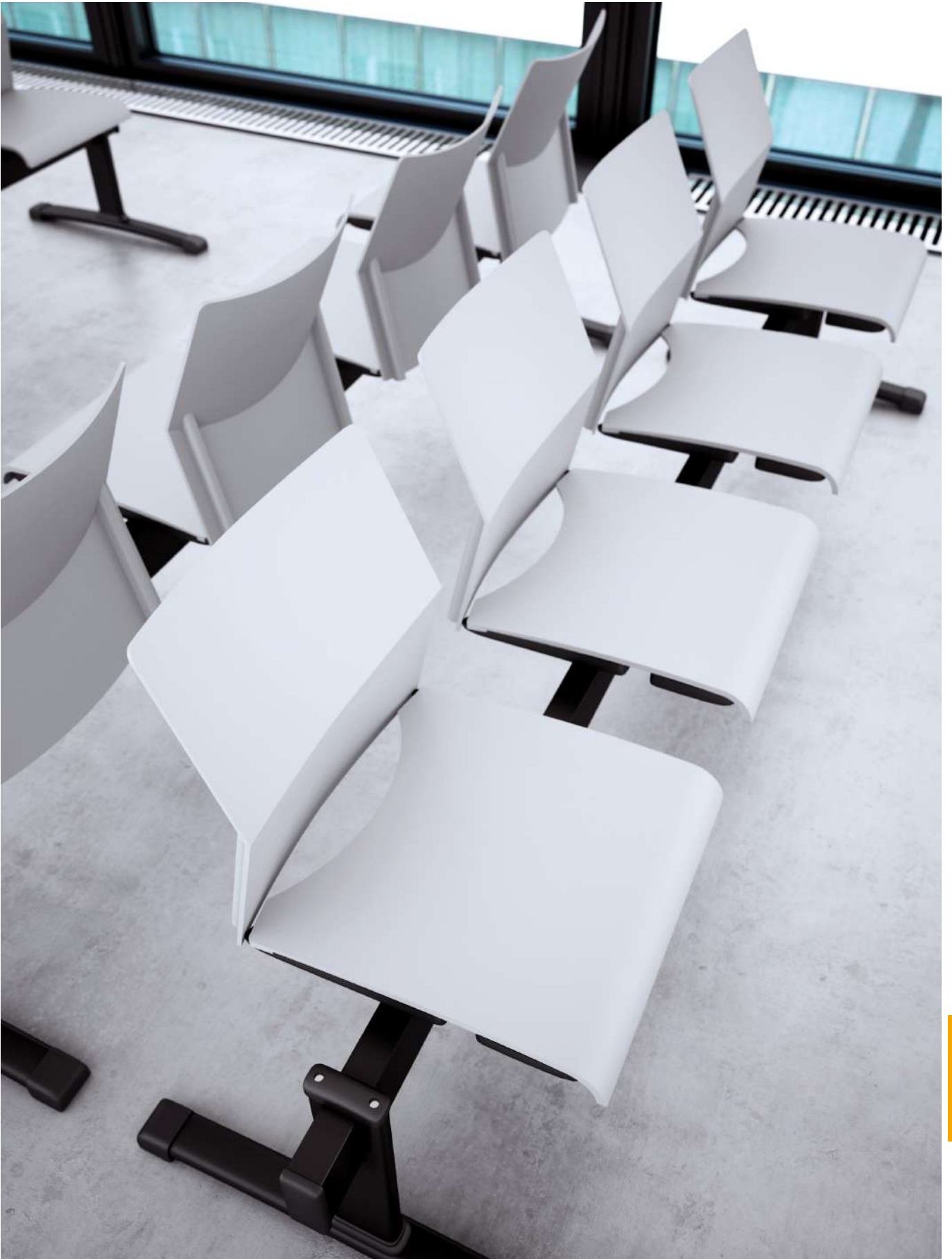

INTRODUCTION

TECHNICAL INFORMATION

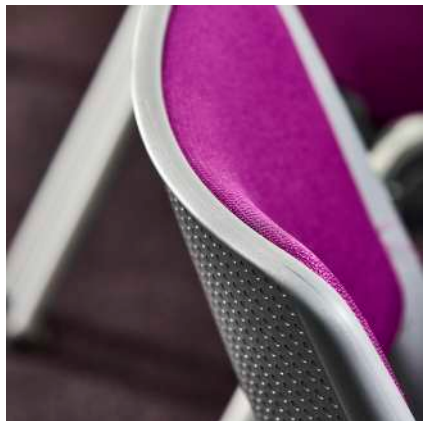

BEAM SEATING SPECIFICATION

TECHNICAL INFORMATION

Please circle required configuration and forward to our Sales Dept. with official order.
Please note only certain ranges are available with five seats.

S = Seat

T = Table

Y or N = Arm (Yes or No)

5 Seat or 4 Seat/1 Table

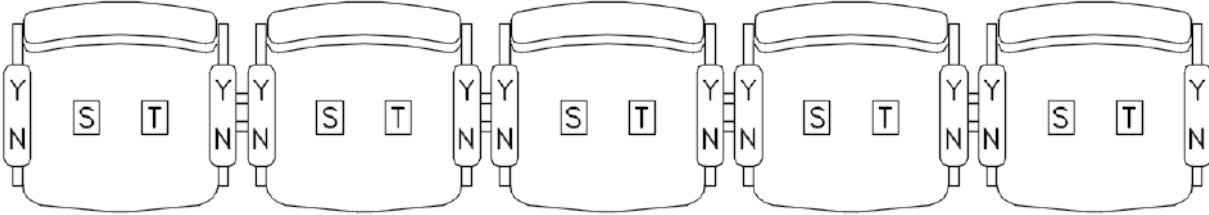

Front of unit.

4 Seat or 3 Seat/1 Table

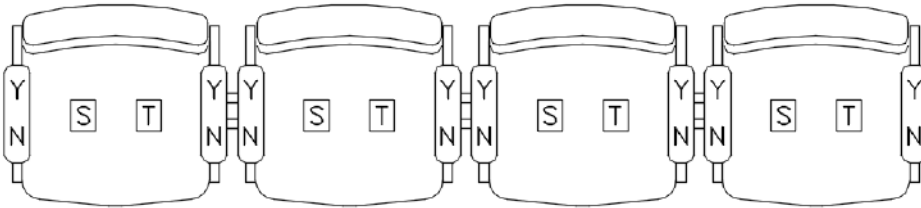

Front of unit.

3 Seat or 2 Seat/1 Table

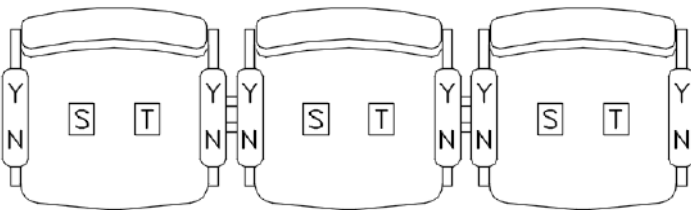

Front of unit.

2 Seat

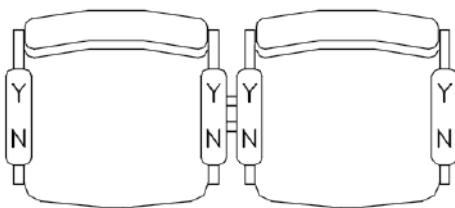

Front of unit.

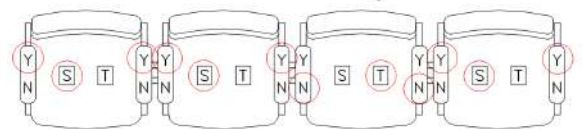

Example

GALLEN DIMENSIONS

TECHNICAL INFORMATION

- Available with optional fitted service modules where shown.
- Each module contains 1x UK power outlet and 1x twin USB fast charge outlet. Supplied with 3m lead to UK plug.
- Suffix code with 'P' to specify sofa with service module.

Additional Information
All dimensions are approximate and should be used as a guide only.

● Denotes position of service module.

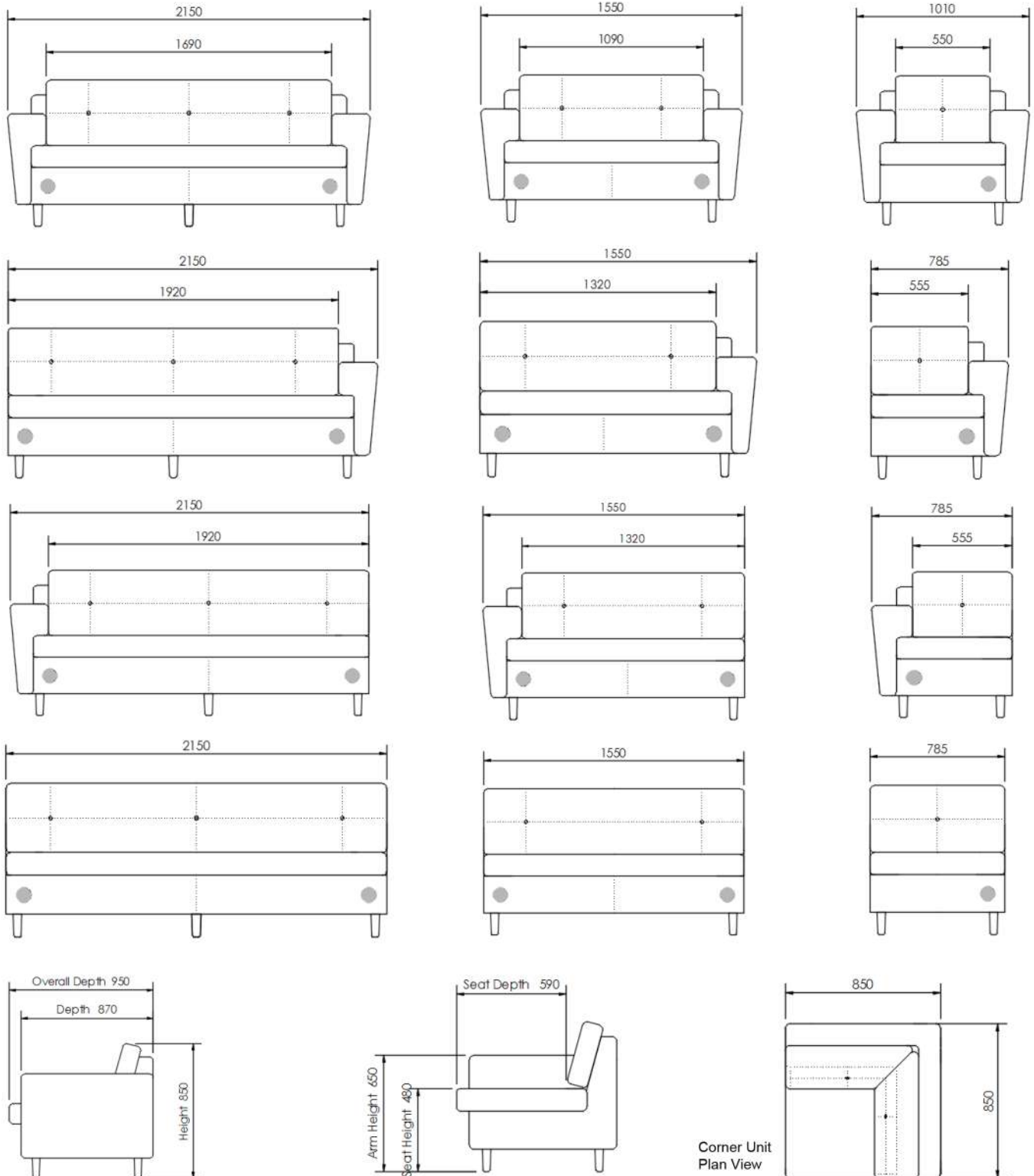

TAKE UP BOOTH DIMENSIONS

TECHNICAL INFORMATION

A variation of our high-back Take Up sofa system.

- All connector walls are supplied with concealed fixings for TV bracket or table use.
- Tables are supplied with square flat bases and fixing brackets.

Additional Information

All dimensions are in millimetres (mm), are approximate and should be used as a guide only.

Unit Side Views

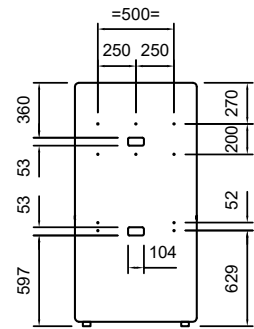
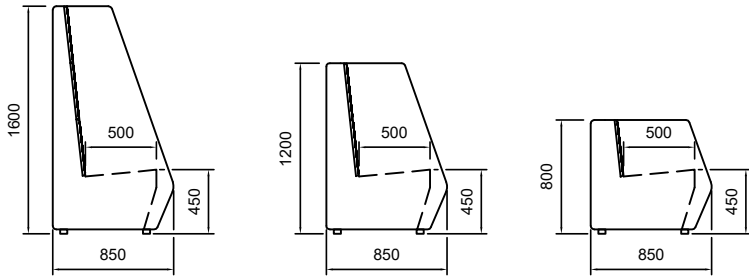

1600 High Connector Wall fixings & cut out positions.

4 User Unit Plan View

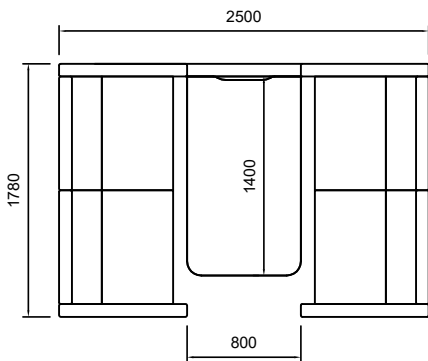

2 User Unit Plan View

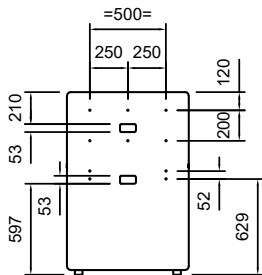
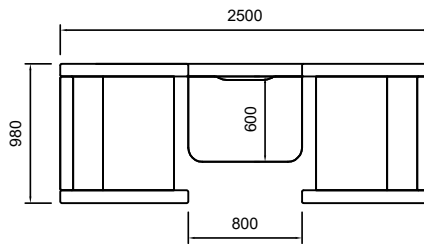

1200 High Connector Wall fixings & cut out positions.

2 User R/Hand Unit Plan View

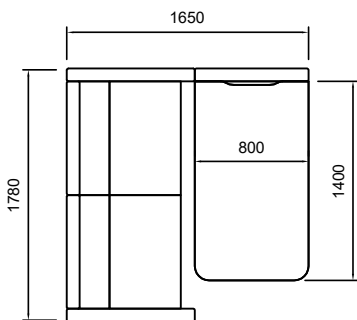

1 User R/Hand Unit Plan View

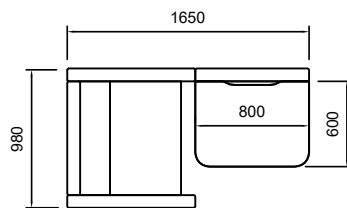

2 User L/Hand Unit Plan View

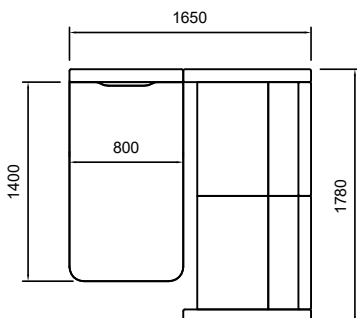

1 User L/Hand Unit Plan View

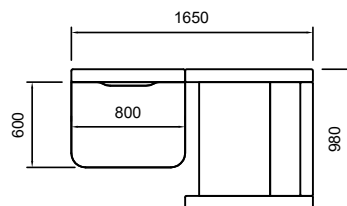

SEATING DIMENSIONS

TECHNICAL INFORMATION

Adlington										
	AO/4	AO/4A2	AO/4A8	AO/9	AO/9A2	AO/9A8	AOC	AOC/A2	AOD/4	AOD/4A2
OA Height:	970-1200	970-1200	970-1200	970-1200	970-1200	970-1200	990	990	1125 - 1495	1125 - 1495
OA Width:	640	640	640	640	640	640	490	580	640	640
OA Depth:	640	640	640	640	640	640	600	600	640	640
OA Arm Height:	-	575-705	645-820	-	575-705	645-820	-	685	-	725 - 1090
Seat Height:	480-585	480-585	480-585	480-585	480-585	480-585	495	495	640-890	640-890
Seat Width:	490	490	490	490	490	490	490	490	490	490
Seat Depth:	465	465	465	465	465	465	465	465	465	465

Adlington		
	AO/4A13	AO/9A13
OA Height:	970-1200	970-1200
OA Width:	640	640
OA Depth:	640	640
OA Arm Height:	605-775	605-775
Seat Height:	480-585	480-585
Seat Width:	490	490
Seat Depth:	465	465

Adlington Mesh									
	AM/4	AM/4A2	AM4A8	AM/9	AM/9A2	AM/9A8	AMD/4	AMD/4A2	
OA Height:	1015-1245	1015-1245	1015-1245	1015-1245	1015-1245	1015-1245	1125 - 1495	1125 - 1495	
OA Width:	640	640	640	640	640	640	640	640	
OA Depth:	640	640	640	640	640	640	640	640	
OA Arm Height:	-	575-705	645-820	-	575-705	645-820	-	725-1090	
Seat Height:	480-585	480-585	480-585	480-585	480-585	480-585	640-890	640-890	
Seat Width:	490	490	490	490	490	490	490	490	
Seat Depth:	465	465	465	465	465	465	465	465	

Adore								
	AD1	AD2	AD3	AD5	AD11	AD12	AD13	AD14
OA Height:	820	700	950	820	790	925	800	855
Seat Height:	400	400	760	460	430	460	435	495
OA Width:	660	660	500	570	580	580	580	580
OA Depth:	560	560	480	530	600	600	600	600

Alsen							
	UJA1	UJA3	UJA4	UJA5	UJA6	UJA7	UJA8
OA Height:	820	820	770	920	825	800	925
Seat Height:	450	450	650	800	450	450	450
OA Width:	510	470	480	480	475	500	500
OA Depth:	540	540	510	510	540	500	500

Alvier Wooden Leg								
	NS1BW	NS2BW	NS1HW	NS2HW	NS1W	NS2W	NS2PBW	NS2PHW
OA Height:	750	750	830	830	450	450	750	830
Seat Height:	450	450	450	450	450	450	450	450
OA Width:	980	1600	980	1600	980	1600	1600	1600
OA Depth:	680	680	680	680	680	680	680	680

Alvier Sled Leg								
	NS1BS	NS2BS	NS1HS	NS2HS	NS1S	NS2S	NS2PBS	NS2PHS
OA Height:	750	750	830	830	450	450	750	830
Seat Height:	450	450	450	450	450	450	450	450
OA Width:	980	1600	980	1600	980	1600	1600	1600
OA Depth:	680	680	680	680	680	680	680	680

Alvier Tube Leg								
	NS1BM	NS2BM	NS1HM	NS2HM	NS1M	NS2M	NS2PBM	NS2PHM
OA Height:	750	750	830	830	450	450	750	830
Seat Height:	450	450	450	450	450	450	450	450
OA Width:	980	1600	980	1600	980	1600	1600	1600
OA Depth:	680	680	680	680	680	680	680	680

Atrium				
	ATF1W	ATF2W	ATF1	ATF2
OA Height:	880	880	880	880
Seat Height:	460	460	460	460
OA Width:	600	1200	600	1200
OA Depth:	610	610	610	610

A51	
	A51
OA Height:	800
OA Width:	505
OA Depth:	500
Seat Height:	450

Betsy							
	BETS	BET4	BET4W	BETP	BETPW	BETZ	BETPZ
OA Height:	790	702-802	760-860	790	850	790	790
Seat Height:	480	392-492	450-550	480	540	480	480
OA Width:	650	650	650	650	650	650	650
OA Depth:	610	610	610	610	610	610	610

Betsy Sofa		
	BET2Z	BET2S
OA Height:	800	800
Seat Height:	470	470
OA Width:	1240	1240
OA Depth:	670	670

SEATING DIMENSIONS

TECHNICAL INFORMATION

BL6	
	BL6
OA Height:	830
OA Width:	440
OA Depth:	525
Seat Height:	460

Bretten		
	BRE1	BREHS
OA Height:	825	1070
OA Width:	480	480
OA Depth:	505	505
Seat Height:	450	760

Bromley 24/7				
	AXR24/7	AXR24/7A22	AX24/7	AX24/7A22
OA Height:	1205-1360	1205-1360	1015-1175	1015-1175
OA Width:	680	705	680	705
OA Depth:	680	680	680	680
OA Arm Height:	-	610-860	-	610-860
Seat Height:	510-610	510-610	510-610	510-610
Seat Width:	520	520	520	520
Seat Depth:	590	590	590	590

Cafe/Bistro								
	TS20W(SP)	TC4D(SP)	TC34N(SP)	TVR1(SP)	EG04N(SP)	EG04W(SP)	EG05N(SP)	EG05W(SP)
OA Height:	835	850	850	850	850	850	845	845
Seat Height:	460	510	500	500	450	450	450	450
OA Width:	495	490	510	510	510	510	510	510
OA Depth:	445	450	455	455	450	450	450	450

Chatte						
	CH1W	CH2W	CH3W	CH1M	CH2M	CH3M
OA Height:	750	750	750	750	750	750
Seat Height:	430	430	430	430	430	430
OA Width:	720	1360	1830	720	1360	1830
OA Depth:	670	670	670	670	670	670

Claire			
	CY1	CY2	CY3
OA Height:	880	880	880
Seat Height:	420	420	420
OA Width:	920	1360	1910
OA Depth:	900	900	900

Coso				
	COS4	COS4A	COS65	COS75
OA Height:	795	805	820	920
OA Width:	465	565	445	445
OA Depth:	545	545	480	480
Seat Height:	445	445	655	755

Cubes and Arrows					
	ES01	ES01M	ES01C	AR1	AR1M
OA Height:	460	460	460	460	460
Seat Height:	460	460	460	460	460
OA Width:	500	500	500	770	770
OA Depth:	500	500	500	500	500

Curves, Ovals and Rectangles						
	EC2	EC2M	ER2	ER2M	ES02	ES02M
OA Height:	460	460	460	460	460	460
Seat Height:	460	460	460	460	460	460
OA Width:	1200	1200	1200	1200	1230	1230
OA Depth:	500	500	450	450	500	500

Doodh		
	NSST	NSCT
OA Height:	450	500
OA Width:	450	800
OA Depth:	450	800
Seat Height:	450	-

Gallen						
	GAL1	GAL2	GAL3	GAL1H	GAL2H	GAL3H
OA Height:	850	850	850	1190	1190	1190
Seat Height:	480	480	480	480	480	480
OA Width:	1010	1560	2150	1010	1560	2150
OA Depth:	950	950	950	950	950	950

Garo	
	KARG1
OA Height:	820
OA Width:	480
OA Depth:	470
Seat Height:	460

GC5		
	GC5B1	GC5B2
OA Height:	850	850
OA Width:	455	455
OA Depth:	680	680
Seat Height:	640	640

SEATING DIMENSIONS

TECHNICAL INFORMATION

GC7								
	GC7A1	GC7B1	GC7C1	GC7C2	GC7D1	GC7D2	GC7E1	GC7E2
OA Height:	855	855	855	900	790-900	835-945	700-900	835-945
OA Width:	598	598	650	650	650	650	650	650
OA Depth:	540	540	610	610	610	610	610	610
Seat Height:	465	465	465	510	400-510	445-555	400-510	445-555

GD2								
	GD2A1	GD2A2	GD2A5	GD2A6	GD2B1	GD2B2	GD2B5	GD2B6
OA Height:	699	414	699	414	751	462	751	466
OA Width:	455.5	380	1050	1050	400	400	1070	1070
OA Depth:	455.5	380	454.9	380	400	400	400	400
Seat Height:	699	414	699	414	751	462	751	466

GD3			
	GD3B1	GD3B2	GD3B3
OA Height:	800	450	450
OA Width:	360	360	360
OA Depth:	360	360	360
Seat Height:	800	450	450

G Series Fabric				
	GSR/7	GS/7	GSC	GSCA
OA Height:	1210-1380	1070-1240	960	960
OA Width:	680	680	530	530
OA Depth:	680	680	525	525
OA Arm Height: -	-	-	-	-
Seat Height:	470-560	470-560	450	450
Seat Width:	490	490	455	455
Seat Depth:	430-470	430-470	460	460

G Series Mesh				
	GSMR/7	GSM/7	GSMC	GSMCA
OA Height:	1210-1380	1070-1240	960	960
OA Width:	680	680	530	53
OA Depth:	680	680	525	525
OA Arm Height: -	-	-	-	-
Seat Height:	470-560	470-560	450	450
Seat Width:	490	490	455	455
Seat Depth:	430-470	430-470	460	460

Harlequin Executive			
	HQHE-SB1	HQME-SB1	HQEC-SB1
OA Height:	1165-1300	950 - 1080	920
OA Width:	650	650	630
OA Depth:	650	650	640
OA Arm Height:	720 - 810	720 - 810	670
Seat Height:	455 - 590	455 - 590	435
Seat Width:	515	515	515
Seat Depth:	470	470	470

Harlequin Mesh			
	HQHM	HQHM/8	HQHM/A13
OA Height:	1100-1250	1100-1250	1100-1250
OA Width:	700	700	700
OA Depth:	700	700	700
OA Arm Height:	-	680-865	640-820
Seat Height:	510-600	510-600	510-600
Seat Width:	500	500	500
Seat Depth:	440	440	440

Heavy Duty										
	110C	120SM	110SWT	LOS1	230	240M	210S	220M	310	320M
OA Height:	840	840	840	840	865	865	860	860	855	860
OA Width:	510	600	550	526	575	600	585	600	575	590
OA Depth:	550	550	550	550	615	625	615	625	575	575
OA Arm Height:	-	620	-	-	-	630	-	630	-	625
Seat Height:	450	450	450	450	485	485	465	475	485	485
Seat Width:	460	460	460	460	515	515	515	515	515	515
Seat Depth:	475	475	475	475	485	485	485	485	485	485

	330	340M	BAR2	BAR3	420M	410S
OA Height:	870	870	860	860	960	960
OA Width:	590	590	700	700	590	575
OA Depth:	575	575	575	575	575	575
OA Arm Height:	-	625	625	625	625	-
Seat Height:	485	485	485	485	485	485
Seat Width:	515	515	625	625	515	515
Seat Depth:	485	485	485	485	485	485

Hour				
	HR1W	HR1N	HR1SW	HR1SN
OA Height:	810	810	1060	1060
OA Width:	540	540	440	440
OA Depth:	540	540	460	460
Seat Height:	460	460	725	725

Hecta			
	HECS	HECW	HECP
OA Height:	1200	1200	1200
OA Width:	820	820	820
OA Depth:	760	760	760
Seat Height:	430	430	430

SEATING DIMENSIONS

TECHNICAL INFORMATION

Industrial					
	INPU/16	INDPU/16	INS/R	INDS/P	INS/P
OA Height:	785-1020	1000-1330	400-505	665-915	580-830
OA Width:	640	640	640	640	640
OA Depth:	640	640	640	640	640
Arm Height:	-	-	-	-	-
Seat Height:	410-525	580-810	400-505	665-810	580-830
Seat Width:	470	460	350	350	350
Seat Depth:	420	415	350	350	350

Izzey				
	IZH1(FA)	IZH2(FA)	IZLO1(FA)	IZLO2(FA)
OA Height:	1180	1180	800	800
Seat Height:	460	460	460	460
OA Width:	760	1400	760	1400
OA Depth:	770	770	770	770

Izzey Lite			
	IZLT	IZLTS	IZLTW
OA Height:	800	800	782
Seat Height:	460	460	442
OA Width:	620	620	620
OA Depth:	570	570	570

Kast						
	KASFMA2	KASFMA1	KASVMA2	KASLBFMA2	KASLBFMA1	KASLBVMA2
OA Height:	1030-1140	1020-1130	1060	1018 - 1140	1020 - 1130	1048
Seat Height:	530	530	530	530	530	530
OA Width:	640	645	640	640	645	640
OA Depth:	470-570	460-550	490	470-570	460-550	490

Kempton			
	K1	KA	KWMA
OA Height:	800	800	800
OA Width:	510	600	625
OA Depth:	565	565	675
OA Arm Height:	-	670	670
Seat Height:	460	460	460
Seat Width:	460	460	460
Seat Depth:	450	450	450

Klyro High Back							
	KLY1H8	KLY1H1	KLY1H4	KLY1H2	KLY1H7	KLY1H5	KLY1H3
OA Height:	1040	1060	1030	1060	1060	1060	1060
OA Width:	800	800	800	800	800	800	800
OA Depth:	780	780	780	780	780	780	780
Seat Height:	410	430	400	430	430	430	430

	KLY2H4	KLY2H2	KLY2H3	KLY2H7
OA Height:	1060	1060	1060	1060
OA Width:	1440	1440	1440	1440
OA Depth:	780	780	780	780
Seat Height:	430	430	430	430

Klyro Low Back							
	KLY1L8	KLY1L1	KLY1L4	KLY1L2	KLY1L7	KLY1L5	KLY1L3
OA Height:	800	820	790	820	820	820	820
OA Width:	800	800	800	800	800	800	800
OA Depth:	780	770	770	770	770	770	770
Seat Height:	410	430	400	430	430	430	430

	KLY2L4	KLY2L2	KLY2L3	KLY2L7
OA Height:	820	820	820	820
OA Width:	1440	1440	1440	1440
OA Depth:	770	770	770	770
Seat Height:	430	430	430	430

Klyro Meeting Chair								
	KLY1AR8	KLY1AR1	KLY1AR7	KLY1AR5	KLY1AR6	KLYP1	KLYP21	KLYP5
OA Height:	870	870	870	870	870	410	410	410
OA Width:	580	580	580	580	580	550	550	550
OA Depth:	630	630	630	630	630	550	550	550
Seat Height:	490	490	490	490	490	N/A	N/A	N/A

Lahr								
	KA61	KA6S	KA6W1	KA6W2	KA6S66	KA6S80	KA6W65	KA6W80
OA Height:	840	840	840	840	1040	1190	1050	1195
OA Width:	460	460	430	460	460	490	460	495
OA Depth:	520	520	500	520	550	560	465	505
Seat Height:	450	450	450	450	660	800	650	805

LC11 Chrome				
	LC11A1	LC11A3	LC11B1	LC11C1
OA Height:	830	840	820	820
OA Width:	535	490	540	540
OA Depth:	525	510	520	520
Seat Height:	450	460	450	450

LC11 Sled				
	LC11M1	LC11M2	LC11N1	LC11N2
OA Height:	1030	1040	1180	1190
OA Width:	480	480	500	500
OA Depth:	550	550	530	530
Seat Height:	650	660	800	810

SEATING DIMENSIONS

TECHNICAL INFORMATION

LC11 Star				
	LC11F3	LC11G3	LC11Q3	LC11Q4
OA Height:	850	850	800-910	800-910
OA Width:	490	490	611	610
OA Depth:	500	500	570	570
Seat Height:	460	460	420-530	420-530

LC11 Stool						
	LC11K1	LC11K2	LC11L1	LC11L2	LC11P1	LC11P2
OA Height:	1050	1060	1200	1210	1030-1220	1040-1230
OA Width:	470	470	500	500	440	440
OA Depth:	500	500	500	500	490	490
Seat Height:	650	660	800	810	650-840	660-850

LC11 Wood		
	LC11H1	LC11H2
OA Height:	830	840
OA Width:	445	445
OA Depth:	510	510
Seat Height:	450	460

LC17	
	LC17A
OA Height:	790
OA Width:	580
OA Depth:	575
Seat Height:	460

LG1 Chrome			
	LG1A1	LG1B1	LG1G1
OA Height:	815	810	970
OA Width:	580	580	525
OA Depth:	500	520	500
Seat Height:	450	450	760

LG1 Plastic	
	LG1E1
OA Height:	815
OA Width:	510
OA Depth:	480
Seat Height:	450

LG1				
	LG1A1	LG1B1	LG1G1	LG1E1
OA Height:	815	810	970	815
OA Width:	580	580	525	510
OA Depth:	500	520	500	480
Seat Height:	450	450	760	450

LG2			
	LG2A	LG2B	LG2C
OA Height:	810	820	940
OA Width:	560	550	530
OA Depth:	510	500	490
Seat Height:	450	450	760

LG4 Chrome				
	LG4A1	LG4B1	LG4J1	LG4M1
OA Height:	825	825	1015	1130
OA Width:	510	480	510	520
OA Depth:	510	490	490	540
Seat Height:	450	450	655	760

LG4 Plastic	
	LG4E1
OA Height:	820
OA Width:	450
OA Depth:	490
Seat Height:	450

LG4 Wood				
	LG4C1	LG4K1	LG4C1UPH	LG4L1UPH
OA Height:	835	1065	835	1065
OA Width:	460	470	460	470
OA Depth:	460	480	460	480
Seat Height:	450	680	450	680

LG10		
	LG10A	LG10B
OA Height:	780	780
OA Width:	920	1680
OA Depth:	820	820
Seat Height:	470	470
Seat Width:	660	1440
Seat Depth:	660	660

LG27	
	LG27
OA Height:	460
OA Width:	590
OA Depth:	480
Seat Height:	460

SEATING DIMENSIONS

TECHNICAL INFORMATION

LG30				
	LG30A	LG30ST	LG30HA	LG30AT
OA Height:	850	855	1100	850
OA Width:	585	620	580	585
OA Depth:	605	480	450	605
Seat Height:	407	430	750	407

LG31							
	LG31C	LG31LS	LG31HS	LG31CUS	LG31LSUS	LG31HSUS	
OA Height:	790	800	900	790	800	900	790
OA Width:	460	460	480	460	460	480	470
OA Depth:	490	495	500	490	495	500	470
Seat Height:	480	650	750	480	650	750	470

LG32		
	LG32A	LG32B
OA Height:	760	950
OA Width:	460	450
OA Depth:	560	480
Seat Height:	490	770

LG33		
	LG33A	LG33B
OA Height:	790	790
OA Width:	590	590
OA Depth:	570	570
Seat Height:	450	450

Link Plus				
	LK1	LKA	LK1SP	LKASP
OA Height:	815	815	815	815
OA Width:	520	625	520	625
OA Depth:	640	640	640	640
OA Arm Height:	-	645	-	645
Seat Height:	445	445	445	445
Seat Width:	470	470	470	470
Seat Depth:	485	485	485	485

LS24										
	LS24A1	LS24A2	LS24B1	LS24B2	LS24C1	LS24C2	LS24D1	LS24D2	LS24E1	LS24E2
OA Height:	710	860	710	860	710	860	710	860	710	860
OA Width:	610	610	1210	1210	1710	1710	1045	1045	1741	1741
OA Depth:	670	670	670	670	670	670	900	900	1256	1256
Seat Height:	460	460	460	460	460	460	460	460	460	460

LS25				
	LS25A	LS25B	LS25C	LS25D
OA Height:	800	810	780	880
OA Width:	460	615	420	420
OA Depth:	550	550	490	490
Seat Height:	430	430	630	730
Seat Width:	-	460	-	-

LS36				
	LS36A	LS36B	LS36C	LS36D
OA Height:	790	800	810	1105
OA Width:	540	540	560	544
OA Depth:	525	525	525	525
Seat Height:	450	450	450	755

LS37	
	LS37A
Seat:	300ø
Base:	400
Seat Height:	590-840

Lynstock Choice				
	910	910RM	910LM	910AM
OA Height:	830	830	830	830
OA Width:	590	590	590	590
OA Depth:	730	730	730	730
Seat Height:	410	410	410	410

Masca										
	MASC2	MASC4	MASC11	MASC12	MASC13	MASC14	MASC21	MASC22	MASC23	MASC24
OA Height:	1020	770	790-930	800-910	835	900	1020-1160	1030-1140	1065	1130
Seat Height:	440	440	420-550	430-540	470	540	420-550	430-540	470	540
OA Width:	595	595	630	630	630	630	630	630	630	630
OA Depth:	580	580	680	680	680	680	680	680	680	680

Meeting Chair									
	M1	MA	MW	M1SP	MASP	MWSP	M1SBP	MASBP	MWSBP
OA Height:	760	760	760	760	760	760	760	760	760
OA Width:	465	525	525	465	525	525	465	525	525
OA Depth:	525	525	525	525	525	525	525	525	525
OA Arm Height:	-	645	-	-	645	-	-	645	-
Seat Height:	440	440	440	440	440	440	440	440	440
Seat Width:	425	425	425	425	425	425	425	425	425
Seat Depth:	440	440	440	440	440	440	440	440	440

Meroux			
	MER1	MERLS	MERHS
OA Height:	835	455	770
OA Width:	450	385	440
OA Depth:	540	385	440
Seat Height:	450	455	770

SEATING DIMENSIONS

TECHNICAL INFORMATION

Metric Executive				
	MCFB	MCHB	M4FB	M4HB
OA Height:	940	835	905	835
OA Width:	565	565	565	565
OA Depth:	630	630	575	575
OA Arm Height:	645	645	635	635
Seat Height:	460	460	460	460
Seat Width:	505	505	505	505
Seat Depth:	470	470	470	470

Metric Plus							
	MSHBM	M4HBM	MCHBM	MCHBPL	M4HBPL	MSFB	MSHB
OA Height:	815-905	835	835	835	835	920-1010	815-905
OA Width:	640	565	565	565	565	640	640
OA Depth:	640	630	630	630	630	640	640
OA Arm Height:	645	645	945	645	645	625-715	625-715
Seat Height:	460	460	460	460	460	440-530	440-530
Seat Width:	505	505	505	505	505	505	505
Seat Depth:	470	470	470	470	470	470	470

Mod		
	MOD1	MODA
OA Height:	850	850
Seat Height:	510	510
OA Width:	530	530
OA Depth:	435	435

Moons & Rounds										
	R500	R500M	R500C	R800	R800M	R800C	R1000	R1000M	M500	M500M
OA Height:	460	460	460	460	460	460	460	460	460	460
Seat Height:	460	460	460	460	460	460	460	460	460	460
OA Width:	500	500	500	800	800	800	1000	1000	500	500
OA Depth:	500	500	500	800	800	800	1000	1000	500	500

Moons & Rounds						
	M500C	M800	M800M	M800C	M1000	M1000M
OA Height:	460	460	460	460	460	460
Seat Height:	460	460	460	460	460	460
OA Width:	500	800	800	800	1000	1000
OA Depth:	500	800	800	800	1000	1000

Motile		
	MOTSF	MOT4BR
OA Height:	820	860
Seat Height:	440	450
OA Width:	650	670
OA Depth:	650	670

Move Up										
	MU/7	MU/7A23	MU/7A24	MU/7A25	MUM/7	MUM/7A23	MUM/7A24	MUM/7A25	MUC	MUMC
OA Height:	975-1150	975-1150	975-1150	975-1150	1030-1200	1030-1200	1030-1200	1030-1200	1015	1070
OA Width:	680	680	680	680	680	680	680	680	520	520
OA Depth:	680	680	680	680	680	680	680	680	600	600
OA Arm Height: -	-	610	610-760	610-770	-	610	610-760	610-770	-	-
Seat Height:	470-560	470-560	470-560	470-560	470-560	470-560	470-560	470-560	500	500
Seat Width:	490	490	490	490	490	490	490	490	520	520
Seat Depth:	430-470	430-470	430-470	430-470	430-470	430-470	430-470	430-470	490	490

Nao			
	NAO1	NAO2	NAO3
OA Height:	780	780	780
Seat Height:	450	450	450
OA Width:	900	1400	1900
OA Depth:	720	720	720

Neos					
	NPES	NPE4	NPE4W	NPEP	NPEPW
OA Height:	790	780-790	820-920	790	850
Seat Height:	460	40-530	460-560	460	530
OA Width:	490	650	650	550	550
OA Depth:	490	650	650	550	550

Newton							
	650A	651	651A	651AR	651AL	652	652A
OA Height:	1160	950	950	950	950	830	830
OA Width:	635	590	635	635	635	590	635
OA Depth:	760	700	700	700	700	675	675
Seat Height:	480	480	480	480	480	480	480

Note				
	FUS1	FUSA	FUS1SP	FUSASP
OA Height:	840	840	840	840
OA Width:	500	500	500	500
OA Depth:	555	555	555	555
OA Arm Height:	-	625	-	625
Seat Height:	455	455	455	455
Seat Width:	440	440	440	440
Seat Depth:	395	395	395	395

SEATING DIMENSIONS

TECHNICAL INFORMATION

Oli	OL4	OLA4	OLC	OL4SP	OLA4SP	OLCSP	OL4SBP	OLA4SBP	OLCSBP	OLS(SP/SBP)
OA Height:	845	845	845	845	845	845	845	845	845	1150
OA Width:	490	500	540	500	490	540	500	490	540	540
OA Depth:	535	535	510	535	535	510	535	535	510	550
OA Arm Height:	-	670	-	-	670	-	-	670	-	-
Seat Height:	460	460	460	460	460	460	460	460	460	750
Seat Width:	440	440	440	440	440	440	440	440	440	440
Seat Depth:	455	455	455	455	455	455	455	455	455	455

Onio	ONIOU1
OA Height:	685
OA Width:	720
OA Depth:	630
Seat height:	390

Opso	OP14BENSEAT	OP4WAYTAB
OA Height:	525	230
OA Width:	1400	460
OA Depth:	420	460

Osana Bench	KB1SF	KB2SF	KB3SF	KBCS	KBSS	KBPC	KBTS
OA Height:	320	320	320	450	450	90	N/A
OA Width:	600	1200	1800	600	600	600	600
OA Depth:	600	600	600	600	600	600	600

Oscar	No Headrest	Headrest
OA Height:	960-1060	1140-1240
OA Width:	650-710	650-710
OA Depth:	700	700
OA Arm Height:	260-340	260-340
Seat Height:	410-510	410-510
Seat Width:	480	480
Seat Depth:	460	460

Outwood	OR1	ORA	ORR(L)
OA Height:	820	820	820
Seat Height:	430	430	430
OA Width:	610	810	710
OA Depth:	750	750	750

Oxy	OXY1	OXY2	OXY3
OA Height:	680	680	680
Seat Height:	430	430	430
OA Width:	840	1400	1940
OA Depth:	760	760	760

Pennine	XO1	XO2	XO3	XO4	XO5	XO6	XO7	XO8
OA Height:	865	865	855	855	855	865	865	865
OA Width:	520	520	545	545	545	545	545	545
OA Depth:	605	605	555	555	555	555	555	555
Seat Height:	465	465	370	370	370	370	440	440

Platinum Ergo	PLH/3	PLH/3A2	PLH/3A8	PLH/3A13	PLM/3	PLM/3A2	PLM/3A8	PLM/3A13	PLHXC
OA Height:	950-1140	950-1140	950-1140	950-1140	920-1120	920-1120	920-1120	920-1120	990
OA Width:	640	640	640	640	640	640	640	640	525
OA Depth:	640	640	640	640	640	640	640	640	600
OA Arm Height:	-	705-795	680-865	640-820	-	705-795	680-865	640-820	-
Seat Height:	420-540	420-540	420-540	420-540	420-540	420-540	420-540	420-540	480
Seat Width:	515	515	515	515	515	515	515	515	515
Seat Depth:	490	490	490	490	490	490	490	490	490

	PLMD/8	PLMD/8A2
OA Height:	1090-1460	1090-1460
OA Width:	640	640
OA Depth:	640	640
OA Arm Height:	-	830-1090
Seat Height:	640-890	640-890
Seat Width:	515	515
Seat Depth:	490	490

Platinum Mesh	PMH/3	PMH/3A2	PMH/3A8	PMH3A13	PMH/3A4D
OA Height:	1080-1320	1080-1320	1080-1320	1080-1320	1080-1320
OA Width:	660	660	660	660	660
OA Depth:	760	760	760	760	760
OA Arm Height:	660-840	660-840	660-840	660-840	660-840
Seat Height:	440-540	440-540	440-540	440-540	440-540
Seat Width:	520	520	520	520	520
Seat Depth:	470	470	470	470	470

SEATING DIMENSIONS

TECHNICAL INFORMATION

Platinum Plus Squared

	PPSH/3	PPSH/3A2	PPSH/3A8	PPSH/3A13	PPSH/3A4D	PPSM/3	PPSM/3A2	PPSM/3A8	PPSM/3A13	PPSM/3A4D
OA Height:	950-1140	950-1140	950-1140	950-1140	950-1140	920-1120	920-1120	920-1120	920-1120	920-1120
OA Width:	680	680	680	680	680	680	680	680	680	680
OA Depth:	680	680	680	680	680	680	680	680	680	680
OA Arm Height:	-	705-795	680-865	640-820	640-820	-	705-795	680-865	640-820	640-820
Seat Height:	440-540	440-540	440-540	440-540	440-540	440-540	440-540	440-540	440-540	440-540
Seat Width:	515	515	515	515	515	515	515	515	515	515
Seat Depth:	490	490	490	490	490	490	490	490	490	490

	PPSHXC	PPSMXC	PPSMD/8	PPSMD/8A2
OA Height:	990	930	1140-1395	1140-1395
OA Width:	525	525	680	680
OA Depth:	600	600	680	680
OA Arm Height:	-	-	-	830-1090
Seat Height:	480	480	680-940	680-940
Seat Width:	515	515	515	515
Seat Depth:	490	490	490	490

Platinum Plus Round

	PPRBH/3	PPRBH/3A2	PPRBH/3A8	PPRBH/3A13	PPRBH/3A4D	PPRBM/3	PPRBM/3A2	PPRBM/3A8	PPRBM/3A13	PPRBM/3A4D
OA Height:	950-1140	950-1140	950-1140	950-1140	950-1140	950-1120	950-1120	950-1120	950-1120	950-1120
OA Width:	680	680	680	680	680	680	680	680	680	680
OA Depth:	680	680	680	680	680	680	680	680	680	680
OA Arm Height:	-	705-795	680-865	640-820	640-820	-	705-795	680-865	640-820	640-820
Seat Height:	440-540	440-540	440-540	440-540	440-540	440-540	440-540	440-540	440-540	440-540
Seat Width:	515	515	515	515	515	515	515	515	515	515
Seat Depth:	490	490	490	490	490	490	490	490	490	490

	PPRBHXC	PPRBMXC	PPRMD/8	PPRMD/8A2
OA Height:	990	890	1140-1395	1140-1395
OA Width:	525	525	680	680
OA Depth:	600	600	680	680
OA Arm Height:	-	-	-	830-1090
Seat Height:	480	480	680-940	680-940
Seat Width:	515	515	515	515
Seat Depth:	490	490	490	490

Platinum Squared

	PSQH/3	PSQH/3A2	PSQH/3A8	PSQH/3A13	PSQM/3	PSQM/3A2	PSQM/3A8	PSQM/3A13	PSQHXC
OA Height:	970-1160	970-1160	970-1160	970-1160	940-1140	940-1140	940-1140	940-1140	970
OA Width:	640	640	640	640	640	640	640	640	525
OA Depth:	640	640	640	640	640	640	640	640	600
OA Arm Height:	-	705-795	680-865	640-820	-	705-795	680-865	640-820	-
Seat Height:	420-540	420-540	420-540	420-540	420-540	420-540	420-540	420-540	480
Seat Width:	515	515	515	515	515	515	515	515	515
Seat Depth:	490	490	490	490	490	490	490	490	490

Platinum Squared

	PSQMD/8	PSQMD/8A2
OA Height:	1130-1460	1130-1460
OA Width:	640	640
OA Depth:	640	640
OA Arm Height:	-	830-1090
Seat Height:	640-890	640-890
Seat Width:	515	515
Seat Depth:	490	490

Qus

	QUSL	QUS4	QUSRT	QUSLT	QUSC	QUSS8	QUSW
OA Height:	770	770	840	840	760	1000	810
OA Width:	460	460	460	460	460	460	460
OA Depth:	495	495	495	495	495	495	495
Seat Height:	440	440	440	440	440	630	480

Relo

	RELOST1	RELOST2	RELOSW1	RELOSW2
OA Height:	850	880	850	880
OA Width:	825	825	825	825
OA Depth:	875	875	875	875
Seat Height:	450	480	450	480

Richmond

	RIC1	RIC2	RIC3
OA Height:	790	790	790
Seat Height:	420	420	420
OA Width:	800	1400	2150
OA Depth:	1020	1020	1020

Santis Ergo

	SIE/7	SIE/7A1	SIE/7A8	SIE/7A13	SIE/7A4D
OA Height:	1100-1180	1100-1180	1100-1180	1100-1180	1100-1180
OA Width:	680	680	680	680	680
OA Depth:	680	680	680	680	680
OA Arm Height:	-	720-810	680-865	640-820	640-820
Seat Height:	490-600	490-600	490-600	490-600	490-600
Seat Width:	515	515	515	515	515
Seat Depth:	490	490	490	490	490

SEATING DIMENSIONS

TECHNICAL INFORMATION

Santis Squared

	SIS/7	SIS/7A1	SIS/7A8	SIS/7A13	SIS/7A4D
OA Height:	1070-1150	1070-1150	1070-1150	1070-1150	1070-1150
OA Width:	680	680	680	680	680
OA Depth:	680	680	680	680	680
OA Arm Height:	-	720-810	670-840	640-820	640-820
Seat Height:	490-600	490-600	490-600	490-600	490-600
Seat Width:	515	515	515	515	515
Seat Depth:	490	490	490	490	490

SJX Plastic

	SJXP1	SJXPA	SJXPRT/PLT	SJX1P1W	SJXPAW	SJXPRTW/PLTW	SJXCP1	SJXCPA	SJXPRT/CPLT
QA Height:	800	800	800	800	800	800	840	840	840
OA Width:	560	590	630	560	590	630	560	590	630
OA Depth:	550	550	550	550	550	550	560	560	560
OA Arm Height:	-	650	650	-	650	650	-	650	560
Seat Height:	455	455	455	455	455	445	480	480	480
Seat Width:	460	460	460	460	460	460	460	460	460
Seat Depth:	470	470	470	470	470	470	470	470	470

SJX Mesh

	SJXM1	SJXMA	SJXMRT/LT	SJXM1W	SJXMAW	SJXMRTW/LTW	SJXMC	SJXMCA	SJXMRT/LT
OA Height:	800	800	800	800	800	800	840	840	840
OA Width:	560	590	630	560	590	630	560	590	630
OA Depth:	550	550	550	550	550	550	560	560	560
OA Arm Height:	-	650	650	-	650	650	-	650	560
Seat Height:	455	455	455	455	455	455	480	480	480
Seat Width:	460	460	460	460	460	460	460	460	460
Seat Depth:	470	470	470	470	470	470	470	470	470

SJX Fully Upholstered

	SJX1	SJXA	SJXRT/LT	SJX1W	SJXAW	SJXRTW/LTW	SJXC	SJXCA	SJXCRT/LT
OA Height:	800	800	800	800	800	800	840	840	840
OA Width:	560	590	630	560	590	630	560	590	630
OA Depth:	550	550	550	550	550	550	560	560	560
OA Arm Height:	-	650	650	-	650	650	-	650	560
Seat Height:	455	455	455	455	455	455	480	480	480
Seat Width:	460	460	460	460	460	460	460	460	460
Seat Depth:	470	470	470	470	470	470	470	470	470

SJX Upholstered Seat

	SJX1SP	SJXASP	SJXRTSP/LTSP	SJX1SPW	SJXASPW	SJXRTSPW/LTSPW	SJXCSP	SJXCASP	SJXCRTSP/LTSP
OA Height:	800	800	800	800	800	800	840	840	840
OA Width:	560	590	630	560	590	630	560	590	630
OA Depth:	550	550	550	550	550	550	560	560	560
OA Arm Height:	-	650	650	-	650	650	-	650	560
Seat Height:	455	455	455	455	455	455	480	480	480
Seat Width:	460	460	460	460	460	460	460	460	460
Seat Depth:	470	470	470	470	470	470	470	470	470

Solent

	SOL1W	SOL2W	SOL3W	SOL1M	SOL2M	SOL3M
OA Height:	830	830	830	830	830	830
Seat Height:	450	450	450	450	450	450
OA Width:	690	1370	1780	690	1370	1780
OA Depth:	830	830	830	830	830	830

Sound Station

	SST1
OA Height:	1578
Seat Height:	415
OA Width:	1276
OA Depth:	665

Steps Compact Castor

	STCDM	STCDMAU	STCDMAW
OA Height:	843	843	843
Seat Height:	447	447	447
OA Width:	495	615	615
OA Depth:	675	675	675

Steps Compact Sled

	STCB	STCBAU	STCBAW
OA Height:	850	850	850
Seat Height:	475	475	475
OA Width:	576	615	615
OA Depth:	680	680	680

Steps Compact Swivel

	STCS	STCSAU	STCSAW
OA Height:	843	843	843
Seat Height:	447	447	447
OA Width:	495	615	615
OA Depth:	675	675	675

Steps Compact 4 Star

	STCDG	STCDGAU	STCDGAW
OA Height:	843	843	843
Seat Height:	447	447	447
OA Width:	495	615	615
OA Depth:	675	675	675

SEATING DIMENSIONS

TECHNICAL INFORMATION

Steps Lounge Castor					
	STLDM	STLDMAU	STLDMAW	STLDMAHU	STLDMAHW
OA Height:	1000	1000	1000	1310	1310
Seat Height:	445	445	445	445	445
OA Width:	785	785	785	785	785
OA Depth:	825	825	825	935	935

Steps Lounge Sled					
	STLBAU	STLBAW	STLBAHU	STLBAHW	
OA Height:	940	940	1285	1285	
Seat Height:	435	435	435	435	
OA Width:	660	780	780	780	
OA Depth:	825	825	930	930	

Steps Lounge Swivel					
	STLS	STLSAU	STLSAW	STLSAHU	STLSAHW
OA Height:	1000	1000	1000	1310	1310
Seat Height:	445	445	445	445	445
OA Width:	785	785	785	785	785
OA Depth:	825	825	825	935	935

Steps Lounge 4 Star					
	STLDG	STLDGAU	STLDGAW	STLDGAHU	STLDGAHW
OA Height:	1000	1000	1000	1310	1310
Seat Height:	445	445	445	445	445
OA Width:	785	785	785	785	785
OA Depth:	825	825	825	935	935

Stratt Plus										
	STR1W	STR2W	STR3W	R8CURPW	R16CURPW	STR1M	STR2M	STR3M	R8CURPM	R16CURPM
OA Height:	920	920	920	920	920	920	920	920	920	920
Seat Height:	450	450	450	450	450	450	450	450	450	450
OA Width:	660	1260	1750	1130	1910	660	1260	1750	1130	1910
OA Depth:	700	700	700	700	700	700	700	700	700	700

Take Off										
	TO20	TO21	TO23	TO24	TO25	TO27	TO28			
OA Height:	1060-1280	1060-1280	1060-1280	990-1205	990-1205	990-1205	980			
OA Width:	620	620	620	620	620	620	585			
OA Depth:	680	680	680	680	680	680	695			
OA Arm Height:	-	700-820	680-820	-	700-820	700-820	665			
Seat Height:	460-560	460-560	460-560	460-560	460-560	460-560	450			
Seat Width:	490	490	490	490	490	490	475			
Seat Depth:	460-570	460-570	460-570	460-570	460-570	460-570	460			
	ATQZ	ATRZ	A1212Z	A1206Z	A0606Z					
OA Height:	450	450	450	450	450					
OA Width:	630	1200	1200	1200	630					
OA Depth:	630	600	1200	630	630					

Take Off Executive										
	TO1	TO2	TO3	TO4	TO5	TO6	TO7	TO8	TO10	TO11
OA Height:	1225-1400	1225-1400	1225-1400	1225-1400	1225-1400	1225-1400	1225-1400	1225-1400	990-1200	990-1200
OA Width:	620	620	620	620	620	620	620	620	620	620
OA Depth:	680	680	680	680	680	680	680	680	680	680
OA Arm Height:	-	700-820	700-790	680-820	-	700-820	700-790	680-820	-	700-820
Seat Height:	460-560	460-560	460-560	460-560	460-560	460-560	460-560	460-560	460-560	460-560
Seat Width:	490	490	490	490	490	490	490	490	490	490
Seat Depth:	460-570	460-570	460-570	460-570	460-570	460-570	460-570	460-570	460-570	460-570

Take Off Executive			
	TO12	TO13	TO14
OA Height:	990-1200	990-1200	965
OA Width:	620	620	600
OA Depth:	680	680	650
OA Arm Height:	700-790	680-820	665
Seat Height:	460-560	460-560	490
Seat Width:	490	490	490
Seat Depth:	460-570	460-570	490

Take Off Lite						
	TL12	TL12FB	TL12RB	TL12LB	TL06	TL06FB
OA Height:	460	840	840	840	460	840
Seat Height:	460	460	460	460	460	460
OA Width:	1200	1200	1200	1200	633	633
OA Depth:	633	633	633	633	633	633

Take Off Plus Low Back										
	TP1L	TP2LL	TP2LR	TP3L	TP4L	TP5L	TP6LL	TP6LR	TP7TL	TP3SL
OA Height:	830	830	830	830	830	830	830	830	830	830
Seat Height:	470	470	470	470	470	470	470	470	470	470
OA Width:	2890	3340	3340	1690	2890	2890	2890	2890	2390	1090
OA Depth:	1895	2890	2890	695	695	2140	2140	2140	1690	695

	TP8L	TP11L	TP106TL
OA Height:	830	830	830
Seat Height:	470	470	470
OA Width:	2890	2290	2390
OA Depth:	3340	695	2290

SEATING DIMENSIONS

TECHNICAL INFORMATION

Take Off Plus High Back

	TP1H	TP2HL	TP2HR	TP3H	TP4H	TP5H	TP6HL	TP6HR	TP7TH	TP3SH
OA Height:	1360	1360	1360	1360	1360	1360	1360	1360	1360	1360
Seat Height:	470	470	470	470	470	470	470	470	470	470
OA Width:	2890	3340	3340	1690	2890	2890	2890	2890	2390	1090
OA Depth:	1895	2890	2890	695	695	2140	2140	2140	1690	695

	TP8H	TP11H	TP106TH	TP94TMH	TP96TMH
OA Height:	1360	1360	1360	1360	1360
Seat Height:	470	470	470	470	470
OA Width:	2890	2290	2390	2390	2390
OA Depth:	3340	695	2290	1690	2290

Take Off Soft Seating

	AS06	ASQ	AS06LB/RB	AS06FB	AS06FLA/FRA	AS06LBA/RBA	AS06TB	AS66FB	AS06FA	AS66
OA Height:	460	460	840	840	840	840	840	840	840	460
Seat Height:	460	460	460	460	460	460	460	460	460	460
OA Width:	1200	640	1200	1200	1400	1400	1400	640	1600	640
OA Depth:	640	640	640	640	640	640	640	640	640	640

Tiros

	TIR1LB	TIR1HB	TIR2LB	TIR2HB
OA Height:	950	1200	950	1200
OA Width:	910	910	1370	1370
OA Depth:	750	750	750	750
Seat Height:	470	470	470	470
Seat Width:	700	700	1200	1200

Unoa Booth

	UNOBA1	UNOBA2
OA Height:	1310	1310
OA Width:	1390	2380
OA Depth:	700	1390
Seat Height:	430	430
Seat Width:	1090	1090
Seat Depth:	550	550

Take Up

	TKULD	TKULL	TKULR	TKULS/ST	TKULCA/CTA	TKUMD	TKUML	TKUMR	TKUMS/ST	TKUMCA/CTA
OA Height:	1600	1600	1600	1600	1600	1200	1200	1200	1200	1200
Seat Height:	480	480	480	480	480	480	480	480	480	480
OA Width:	980	890	890	800	1600	980	890	890	800	1600
OA Depth:	860	860	860	730	-	860	860	860	730	-

	TKUSD	TKUSL	TKUSR	TKU55	TKU58	TKU58T	TKU516	TKU516T
OA Height:	1200	1200	1200	450	450	350	450	350
Seat Height:	450	450	450	450	450	-	450	-
OA Width:	980	890	890	500	800	800	1600	1600
OA Depth:	860	860	860	500	500	500	500	500

Take Up

	TKUFD	TKUFL	TKUFR	TKUFS/ST	TKUECA/CTA
OA Height:	800	800	800	800	800
Seat Height:	480	480	480	480	480
OA Width:	980	890	890	800	1600
OA Depth:	860	860	860	730	-

Tamper Proof

	TPPBC	290
OA Height:	930 - 1090	910 - 1015
OA Width:	640	640
OA Depth:	640	640
OA Arm Height:	-	-
Seat Height:	450 - 560	480 - 585
Seat Width:	500	500
Seat Depth:	470	485

Theia

	EI1 (SP/BP)	EIA (SP/BP)	EIART/LT (SP/BP)	EIH (SP/BP)	EIAH (SP/BP)	EIL (SP/BP)	EIAL (SP/BP)
OA Height:	815	815	815	1080	1080	980	980
OA Width:	540	570	570	540	570	540	540
OA Depth:	580	580	580	600	600	600	600
OA Arm Height:	-	655	655	-	925	-	825
Seat Height:	460	460	460	730	730	630	630

Visa

	VIS1(SP)	VISA(SP)	VIS1V	VISA(SSP)
OA Height:	795	810	795	790
Seat Height:	470	470	470	470
OA Width:	560	605	560	640
OA Depth:	515	525	515	640

Vona

	LS34A
OA Height:	840
OA Width:	580
OA Depth:	470
Seat Height:	420

SELECTED BAND FABRICS

TECHNICAL INFORMATION

BAND 1

Agua	Task	CRIB 5	140,000 100% Polyester
Camira	Advantage	C&M	50,000 60% Polypropylene, 30% Wool, 10% Viscose
Camira	Era	C&M	100,000 100% Polyester
Camira	Gravity	C&M	50,000 100% Polyester
Camira	Manhattan	C&M	50,000 100% Recycled Polyester
Camira	Phoenix	C&M	100,000 100% Polyester
Camira	Rivet	C&M	80,000 100% Repreve® Recycled Polyester (Plastic bottles)
Camira	X2	CRIB 5	100,000 100% Recycled FR Polyester
Camira	Xtreme	CRIB 5	100,000 100% Recycled FR Polyester
✓ Chieftain	Trimcell Classic	C&M	40,000 PVC / PES
✓ Chieftain	Trimcell Legend	C&M	40,000 PVC / PES
Gabriel	Event	C&M	100,000 100% Polyester
Gabriel	Fighter	C&M	130,000 100% Polyester
Gabriel	Medley	C&M	75,000 100% Polyester
Inloom	Alba	CRIB 5	100,000 100% Polyester
Inloom	Bondai	CRIB 5	150,000 100% Polyester
Inloom	Erika	CRIB 5	70,000 100% Polyester
✓ Panaz	Cadet	CRIB 5	350,000 Coating: PVC, PU, Acrylic, Basecloth: Viscose, Polyester

BAND 2

✓ Agua	Aries	CRIB 5	100,000 90% PVC, 10% Polyester
Agua	Juno	CRIB 5	150,000 100% coated polyester
Agua	Libra	CRIB 5	100,000 100% coated polyester
Agua	Linetta	CRIB 5	100,000 Treated Polyester
✓ Agua	Lunar	CRIB 5	100,000 2% PU, 78% PVC, 20% Cotton
✓ Agua	Paintpot	CRIB 5	100,000 2.0% PU, 59% PVC, 29% Cotton, 10% Polyester
Camira	Aspect	CRIB 5	50,000 75% Trevira CS® FR Polyester, 25% Polyester
Camira	Canopy	C&M	60,000 100% polyester
Camira	Main Line Plus	CRIB 5	50,000 67% Wool, 20% FR Viscose, 13% Viscose
Camira	Patina	CRIB 5	100,000 69% Wool, 22% Flax, 8% Polyamide, 1% Viscose
Camira	Quest	C&M	100,000 100% Recycled Polyester
Camira	Sprint	C&M	100,000 100% Polyester
Camira	Urban	CRIB 5	100,000 100% Recycled FR Polyester
✓ Camira	Vita	CRIB 5	N/A Surface: 98.5% PVC, 1.5% PU Substrate: 50% Polyester, 50% Cotton
✓ Chieftain	Just Colour	CRIB 5	500,000 Phthalate free PVC
✓ Chieftain	Just Pattern	CRIB 5	500,000 Phthalate free PVC
Gabriel	Go Check	CRIB 5	80,000 100% Trevira CS
Gabriel	Go Couture	CRIB 5	80,000 100% Trevira CS
Gabriel	Go Uni	CRIB 5	100,000 100% Trevira CS
Gabriel	Repetto	C&M	100,000 100% Post Consumer Recycled Polyester
Inloom	Jet	CRIB 5	65,000 100% Trevira CS Polyester
Inloom	King Flex	CRIB 5	100,000 100% Trevira CS Polyester
Inloom	One	CRIB 5	100,000 100% Recycled Polyester
Panaz	Altair	CRIB 5	60,000 100% Trevira CS
✓ Panaz	Aston	CRIB 5	750,000 Coating: PVC, PU blend, Basecloth: cotton, polyester
✓ Panaz	Brookland	CRIB 5	350,000 Coating: PVC, PU blend, Basecloth: cotton, polyester
Panaz	Highland	CRIB 5	70,000 100% Polyester with FR Backcoating
Panaz	Highland Stretch	CRIB 5	90,000 Polyester/Elastane blend with FR coating
Panaz	Ultimate Touch	CRIB 5	100,000 Coating: PU/Cellulose, Basecloth: Cotton/Polyester
✓ Spradling	Mardi Gras	CRIB 5	120,000 85% PVC, 15% Cotton

SELECTED BAND FABRICS

TECHNICAL INFORMATION

BAND 3

Agua	Aura	CRIB 5	100,000 100% coated polyester
Agua	Cashmir	CRIB 5	100,000 100% coated polyester
Agua	Furnisoft	CRIB 5	100,000 53% PU, 32% PES, 15 % Cotton
✓ Agua	Fusion	CRIB 5	100,000 2% PU, 74% PVC, 12% Cotton, 12% Polyester
Agua	Nova	CRIB 5	80,000 100% coated polyester
Agua	Oregon	CRIB 5	70,000 100% treated polyester
✓ Agua	Parody	CRIB 5	100,000 Denim: 70% PVC, 30% Cotton Weave: 1 % PU, 65% PVC, 26% Cotton, 8% Polyester
Agua	Sark	CRIB 5	40,000 88% coated polyester, 12% coated Nylon
Agua	Snowdon	CRIB 5	130,000 100% treated polyester
✓ Agua	Stretch	CRIB 5	400,000 2% PU, 78% PVC, 19% Polyester, 1% Elastane
✓ Agua	Taurus	CRIB 5	400,000 2% PU, 74% PVC, 12% PES, 12 % Cotton
Agua	Tones	CRIB 5	100,000 100% coated polyester.
Camira	24/7 Flax	CRIB 5	200,000 50% Polyamide, 30% Wool, 20% Flax
Camira	Halcyon Aspen	CRIB 5	50,000 100% Polyester with TriOnyx backcoat
Camira	Halcyon Blossom	CRIB 5	50,000 100% Polyester with TriOnyx backcoat
Camira	Halcyon Cedar	CRIB 5	60,000 100% Polyester with TriOnyx backcoat
Camira	Hi-Tech	C&M	60,000 60% Polypropylene, 29% Wool, 10% Viscose, 1% Carbon Fibre
Camira	Kyoto	C&M	200,000 90% Wool, 10% Polyamide
Camira	Main Line Flax	CRIB 5	50,000 70% Virgin Wool, 30 % Flax
Camira	Oceanic	C&M	100,000 100% Recycled Polyester, including 50% SEAQUAL yarn
Camira	Sumi	C&M	200,000 90% Wool, 10% Polyamide
Camira	Synergy	C&M*	100,000 95% Virgin Wool, 5% Polyamide
✓ Chieftain	Lionella	CRIB 5	500,000 Phthalate free PVC / PU
Gabriel	Atlantic	C&M	110,000 100% polyester
Gabriel	Capture	C&M	200,000 85% wools of New Zealand, 15% polyamide
Gabriel	Europost 2	CRIB 5	50,000 100% Wool
Gabriel	Gaja Classic	CRIB 5	50,000 100% wool
Gabriel	Step	CRIB 5	100,000 100% Trevira CS
Gabriel	Step Melange	CRIB 5	100,000 100% Trevira CS
Inloom	Jeans	CRIB 5	75,000 100% Trevira CS
Inloom	Jet Bioactive	CRIB 5	65,000 100% Trevira CS Antimicrobial Polyester
Inloom	Milano	CRIB 5	80,000 100% Trevira CS Polyester
Inloom	Riva	CRIB 5	100,000 100% Trevira CS Polyester
Inloom	Roccia	CRIB 5	70,000 100% Trevira CS Polyester
✓ Panaz	Haven	CRIB 5	300,000 PolyesterNiscose with PVC/PU coating
Panaz	Microvelle	CRIB 5	60,000 100% polyester with microporous film and FR coating
✓ Panaz	Sheema	CRIB 5	90,000 Coating: PVC, PU blend, Basecloth: cotton, polyester
Panaz	Soft Touch	CRIB 5	100,000 Coating; PU, Cellulose, Basecloth: cotton, polyester
✓ Panaz	Stingray	CRIB 5	90,000 Coating: PVC, PU blend, Basecloth: cotton, polyester
✓ Spradling	Silvertex	C&M	300,000 Vinyl / Urethane Topcoat
✓ Spradling	Valencia	C&M	300,000 Vinyl / Urethane Topcoat

BAND 4

✓ Agua	Mystique	CRIB 5	100,000 1% PU, 64% PVC, 24% Polyester, 11% Cotton. Substrate: 50% PES, 50% Cotton
✓ Agua	The 7 Collection	CRIB 5	100,000 Vinyl: 1.0% PU, 80.0% PVC, 5% PES, 14% Cotton
Camira	Aquarius	C&M*	50,000 100% Virgin Wool
Camira	Blazer	C&M*	50,000 100% Virgin Wool
Camira	Silk	CRIB 5	50,000 67% Wool, 22% Flax, 11% Silk
Camira	Track	CRIB 5	80,000 100% Trevira CS® FR Polyester
Camira	Yoredale	C&M	50,000 95% wool, 3% Polyester, 2% polyamide
Camira	Zap	C&M	100,000 83% wool, 17% polyamide
Gabriel	Breeze Fusion	C&M	100,000 92% Wool, 8% Polyamide
Gabriel	Crisp	C&M	200,000 93% Wool, 3% Polyamide
Gabriel	Fame	CRIB 5	200,000 95% wool, 5% Polyamide
Gabriel	Fame Hybrid	CRIB 5	150,000 95% wool, 5% Polyamide
Gabriel	Luna2	CRIB 5	70,000 90 % Wool, 10 % Polyamide
Gabriel	Mood	C&M	5,000 92% wool, 8% polyamide
Inloom	Corte	CRIB 5	50,000 100% Trevira CS Polyester
Inloom	Spazio	C&M	50,000 100% Recycled Polyester
Kvadrat	Remix	C&M*	100,000 90% New wool (worsted), 10% Nylon
Svensson	Khaki	CRIB 5	50,000 100% Trevira CS (flame retardant)
✓ Vescom	Cyprus	CRIB 5	125,000 vinyl coat, cotton/polyester backing
✓ Vescom	Dalma	CRIB 5	125,000 vinyl coat, cotton/polyesterbacking
✓ Vescom	Furka Plus	CRIB 5	125,000 vinyl coat, cotton/polyester backing
✓ Vescom	Leone Plus	CRIB 5	125,000 vinyl coat, cotton/polyester backing
✓ Vescom	Malta	CRIB 5	125,000 vinyl coat, cotton/polyester backing

SELECTED BAND FABRICS

TECHNICAL INFORMATION

BAND 5

Bute	Elgin	CRIB 5	100,000	92% pure new wool, 8% nylon
Bute	Ramshead	CRIB 5	75,000	85% pure new wool, 15% nylon
Bute	Troon	CRIB 5	60,000	92% pure new wool, 8% nylon
Bute	Tumberry	CRIB 5	80,000	92% pure new wool, 8% nylon
Camira	Craggan Flax	CRIB 5	50,000	85% Wool, 10% Flax, 5% Polymide
Gabriel	Crisscross	CRIB 5	110,000	89% Wool, 11% Polyamide
Svensson	Rock	C&M	50,000	85% wool, 15% polyamide
Svensson	Step	CRIB 5	50,000	75% wool, 19% polyester
Vescom	Cres	CRIB 5	50,000	100% flame retardant polyester

BAND 6

Bute	Alchemy	CRIB 5	80,000	61% Merino, 33% Pure New Wool, 6% Nylon
Bute	Lewis	CRIB 5	43,000	100% pure new wool
Bute	Tweed	CRIB 5	50,000	100% pure new wool
Svensson	Accessoire	C&M	50,000	85% wool, 15% polyamide
Svensson	Ink	CRIB 5	60,000	85% wool, 15% polyamide

BAND 7

Bute	Melrose	CRIB 5	80,000	93% pure new wool, 7% nylon
Camira	Synergy Quilt Channel	C&M	100,000	95% Virgin Wool, 5% Polyamide with Polyester and Polyurethane foam backing
Camira	Synergy Quilt Chevron	C&M	100,000	95% Virgin Wool, 5% Polyamide with Polyester and Polyurethane foam backing
Camira	Synergy Quilt Hourglass	C&M	100,000	95% Virgin Wool, 5% Polyamide with Polyester and Polyurethane foam backing
Kvadrat	Clara	C&M*	80,000	92% New wool (worsted), 8% Nylon
Vescom	Hestan	CRIB 5	60,000	100% flame retardant polyester
Vescom	Lindau	C&M*	100,000	80% wool, 20% polyamide

LEATHER GROUP 1

Crest / JMT Shelly

Leather Group 1 is for selected Shelly hides. Other colours from this range are available but could be subject to a surcharge dependant on leather maximisation, POA. Please note that all leathers are subject to natural markings and variations in shade. These natural bruise marks distinguish it from man made imitations. The variations are features, not faults.

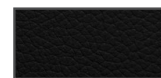

Black

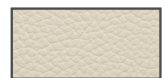

Cream

OTHER INFORMATION

Fire Retardancy

All information regarding fire retardancy has been provided by the fabric manufacturer.

Flame Retardancy Ratings:

C&M	Cigarette and Match = Low Hazard
C&M*	Cigarette & Match as standard. Can be treated to achieve Crib 5 upon request.
CRIB 5	Medium Hazard
CRIB 5*	Medium Hazard when used over CMHR 50kg Foam.

Abrasion

All information regarding abrasion has been provided by the fabric manufacturer and communicates wear resistance as determined by the Martindale abrasion test.

Vinyl

Fabrics marked with  are Vinyl.

Product leadtimes may be affected by the fabric selected. Please contact our Sales Department for further information.

Please Note:

Fabrics other than those listed above are available. These fabrics may require testing to ensure their suitability for use on the intended product. Not all fabrics shown are suitable for use across all ranges within this document. Due to their specification, certain fabrics may have a detrimental effect on the final appearance of a product.

WOOD, METAL & LAMINATE FINISHES

TECHNICAL INFORMATION

GRESHAM MFC COLLECTION

A chic choice of 13 classic wood grain finishes and 5 fashionable yet subtle colours. Match or complement your chosen MFC with environmentally friendly, superior high impact resistant ABS edging.

Please Note: There is a Surcharge on Adlington Oak and Light Concrete



NEW FOR 2022

THE PASTEL MFC COLLECTION

Accent Colours for Doors and Draw Fronts only.

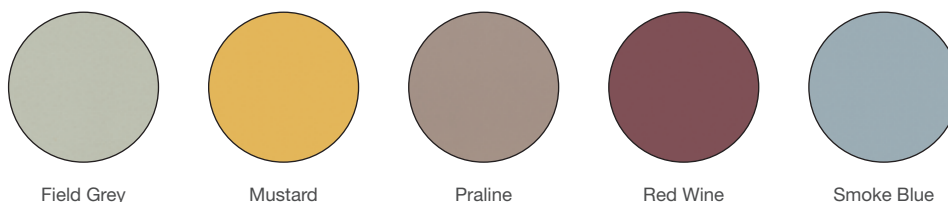

METAL FINISHES

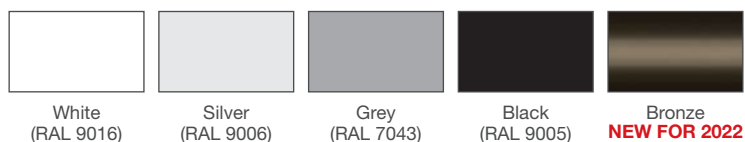

PASTEL METAL FINISHES

£26 Surcharge applicable on all Pastel Metal Finishes



WOOD, METAL & LAMINATE FINISHES

TECHNICAL INFORMATION

THE KIKO COLLECTION

A deluxe selection of plain colours, wood grain effect High Pressure Laminate finishes.
Match or complement your chosen Laminate with environmentally friendly, superior high impact resistant ABS edging.



NEW FOR 2022
Adlington Oak MFC

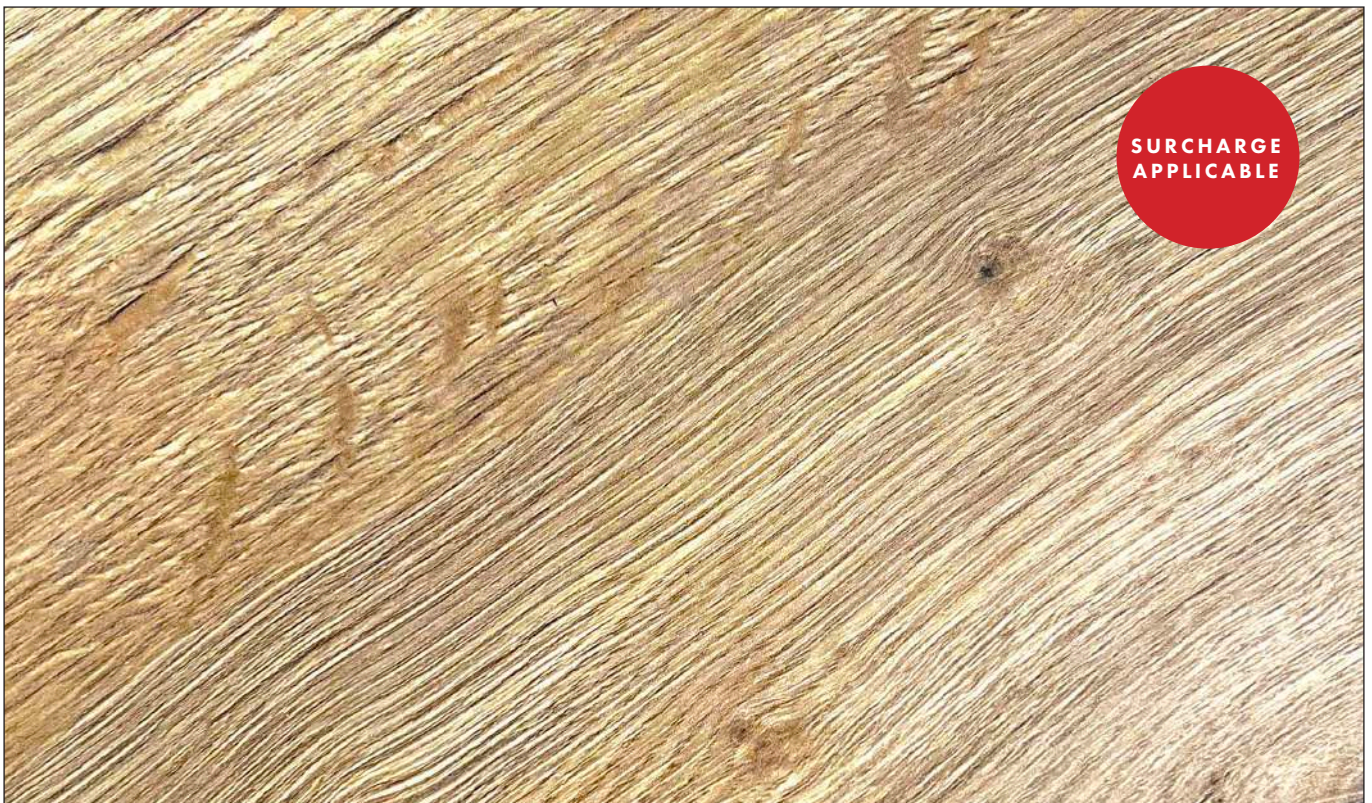

WOOD, METAL & LAMINATE FINISHES

TECHNICAL INFORMATION

**SURCHARGE
APPLICABLE**

THE HALO COLLECTION

120 Plain Colours answering key interior trends for new blues, pastels and nature inspired eco palettes.
We have a large selection of matching Edging to choose from that perfectly complements our Halo Collection.

F0949 White	F2696 Super White	F2255 Polar White	F1093 Aries	F7934 Pearl	F2001 Baikal	F3091 Crystal White	F2274 Blanc Polaire	F2010 Malibu
F7927 Folkestone	F7923 Surf	F2791 Silver	F7938 Glacier	F1484 Steel	F1994 Fox	F7961 Fog	F7902 Iron	F7858 Pumice
F0189 Sparta	F7924 Lead	F1535 Tornado	F7928 Mouse	F2770 Sarum Grey	F3202 Otter	F7912 Storm	F2297 Terril	F7837 Graphite
F2253 Diamond Black	F9266 Citadel	F5342 Earth	F7949 Soft White	F1534 Magnolia	F1192 Porcelana	F1040 Alpino	F7932 Antique White	F2273 Seringa
F1531 Irish Cream	F2774 New Magnolia	F0547 Papyrus	F2296 Snow White	F0901 Gobi	F2833 Sandstone	F3050 Cygnet	F7929 Oyster Grey	F1532 Eldorado
F7882 Pale Gold	F7940 Spectrum Yellow	F1803 Tenere	F8751 Mojave	F0187 Kashmir	F0903 Cafe	F1485 Chrome Yellow	F3209 Sol	F4156 Caramel
F8757 Choco	F2200 Dark Chocolate	F8823 Patina	F8857 Just Gold	F4155 Sun	F4161 Terracotta	F3210 Levante	F5348 Energy	F8858 Just Rose

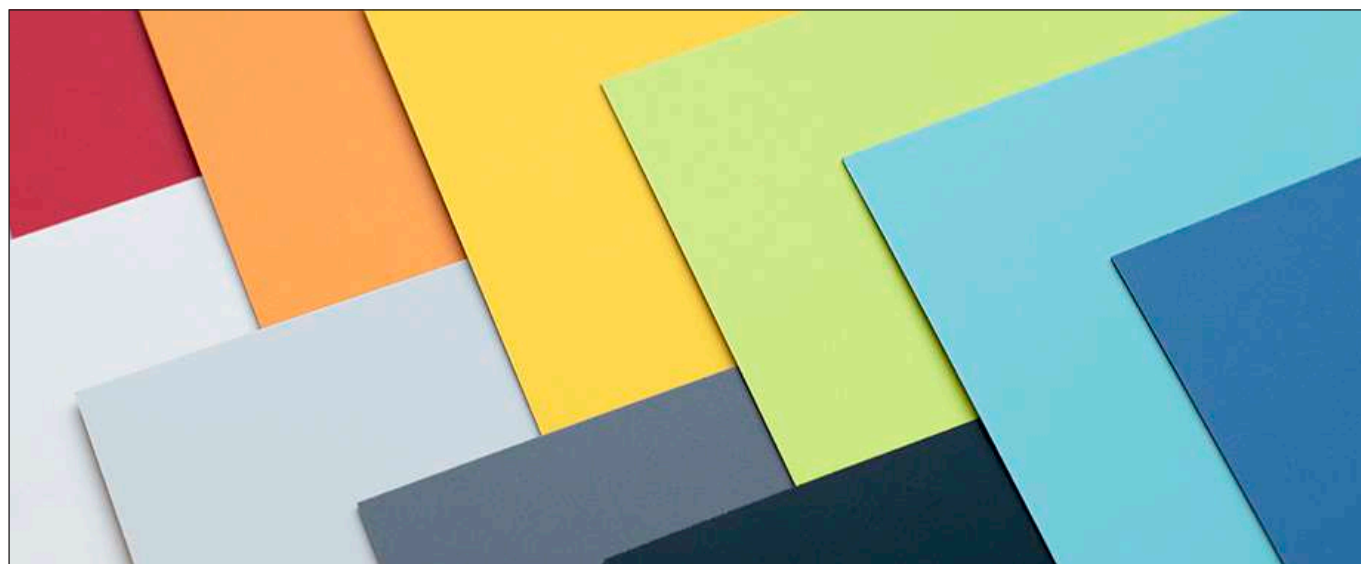



WOOD, METAL & LAMINATE FINISHES

TECHNICAL INFORMATION

THE HALO COLLECTION CONTINUED

120 Plain Colours answering key interior trends for new blues, pastels and nature inspired eco palettes.
We have a large selection of matching Edging to choose from that perfectly complements our Halo Collection.

F2582 Lilac	F0231 Peaceful Blue	F1194 Iris	F2962 Clementine	F1238 Carnaval	F0232 Juicy Pink	F1019 Azur	F7880 Thistle	F2824 Blaze Red
F7845 Spectrum Red	F6907 Amarena	F5346 Orchid	F4168 Campanula	F1997 Oceano	F6902 Grenadine	F0188 Beaujolais	F5345 Viola	F2483 Ultramarine
F7851 Spectrum Blue	F2828 Tropical Blue	F2005 Paprika	F7966 New Burgundy	F6903 Cassis	F7969 Navy Blue	F7914 Marine Blue	F8821 Just Blue	F5493 Arctic Blue
F5494 Aquamarine	F5127 Monaco	F2966 Opal	F3236 Avocado	F5344 Seed	F1998 Oslo	F1850 Fontana	F5349 Fossil	F8755 Lemon
F0800 Artichoke	F7884 China Blue	F5347 Maui	F7879 Dusty Jade	F7853 Ocean Grey	F4177 Lime	F5341 Wasabi	F8822 Denim	F4172 Caribbean
F1326 Capri	F7897 Spectrum Green	F6901 Vibrant Green	F3007 Pale Olive	F0157 Tahiti	F7846 Grotto	F2478 Bermuda	F7967 Hunter Green	F8820 Leaf Green
F5343 Possum	F0233 Heather	F5323 Nocturne						

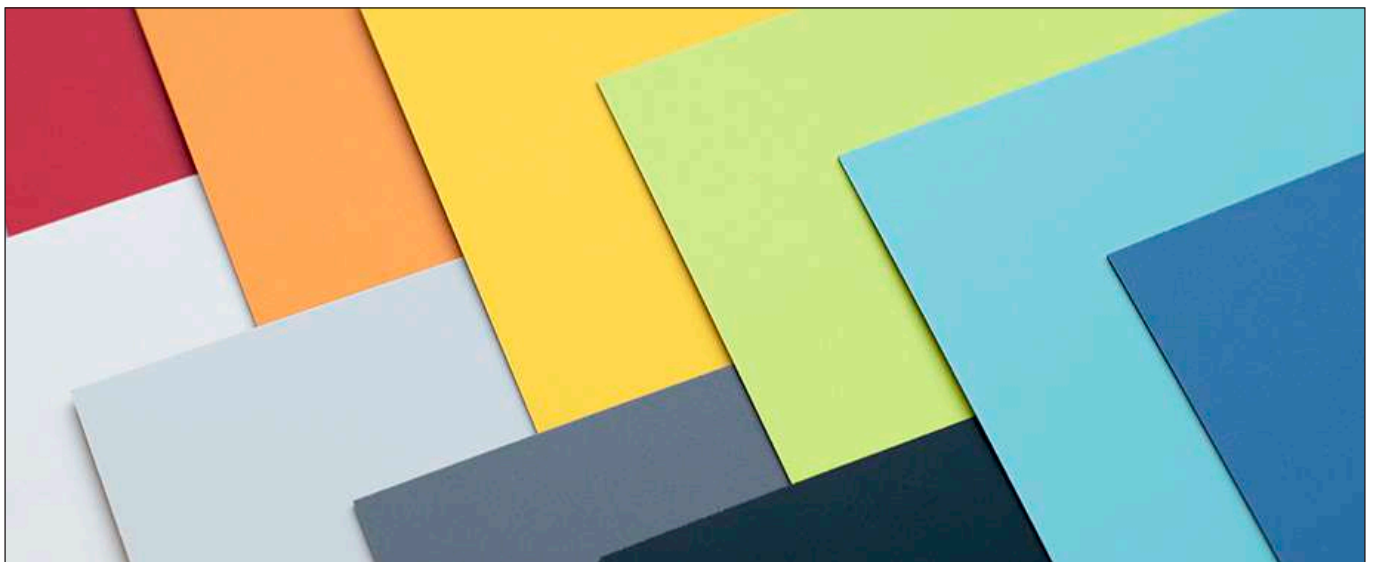

THE FENIX COLLECTION

Fenix, the nanotechnological material from Arpa Industriale, has revolutionised the world of interior design. It is not only beautiful to look at but, most importantly, it is also a high-tech material, made unique by its characteristics.

Fenix has these characteristics by undergoing a particular series of processes, including a multilayer coating and the use of next-generation nanoparticles and acrylic resins, which are hardened and cured through an innovative Electron Beam Curing process. This process makes the material anti-fingerprint, soft to the touch, opaque and extremely durable, so much so that it can withstand serious knocks and scratches, but also makes it highly resistant to the aggressive action of solvents and reagents typically used for household cleaning.

Fenix is also heat-resistant. Additionally, should the surface have superficial microscratches, heat actually helps to repair them. The surface of the material is scattered with a dense grid of crosspolymers with their own memory, which can be reactivated by the application of heat.

Fenix is also water-repellent, hygienic, thanks to its effective bacteria-killing action, and resistant to mould. All of these make it a perfect surface for contact with food and very easy to clean.

We have a large selection of matching Edging to choose from that perfectly complements our Fenix Collection.



WOOD, METAL & LAMINATE FINISHES

TECHNICAL INFORMATION

FURNITURE LINOLEUM – DESKTOP

The Furniture Linoleum Desktop collection consists of 21 elegant colours that add a distinctive touch to any piece of furniture.



FIND US ON SOCIAL MEDIA



FACEBOOK

Gresham Office Furniture

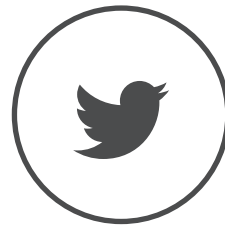

TWITTER

@gresham ltd

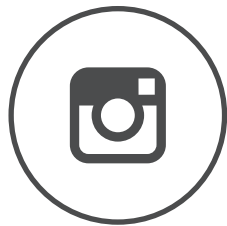

INSTAGRAM

GreshamOfficeFurniture



LINKEDIN

linkedin@gof.co.uk



We've come a long way since

1976

and we're not done yet



GRESHAM

Registered in England No 1284733

Head Office Platinum Park | Lynstock Way | Horwich | Bolton | BL6 4SA
Tel: 01204 664422 | Fax: 01204 664433 | Email: info@gof.co.uk

London Showroom 28 St John's Lane | Clerkenwell | London | EC1M 4BU
Tel: 020 7242 5709 | Email: londonshowroom@gof.co.uk

WWW.GOF.CO.UK